

China Daheng Group, Inc. Beijing Image Vision Technology Branch

MERCURY GigE Cameras

User Manual

Version: V1.0.29
Date: 2021-11-16

D HENG | **大恒图像**
IM GING

All rights reserved. No parts of this manual may be used or reproduced, in any forms or by any means, without prior written permission of China Daheng Group, Inc. Beijing Image Vision Technology Branch.

The right is also reserved to modify or change any parts of this manual in the future without prior notification.

All other trademarks are the properties of their respective owners.

© 2021 China Daheng Group, Inc. Beijing Image Vision Technology Branch

Web: www.daheng-imaging.com/en/

Sales Email: isales@daheng-imaging.com

Sales Tel: +86 10 8282 8878

Support Email: isupport@daheng-imaging.com

Preface

We really appreciate your choosing of DAHENG IMAGING products.

The MERCURY GigE series (MER-G) camera is DAHENG IMAGING's mature area scan industrial digital camera, featuring high resolution, high definition and extremely low noise. The camera, which is equipped with a standard GigE interface, supports Power over Ethernet (PoE, compatible of IEEE802.3af standard) and is convenient for use and connection.

The MERCURY family cameras are especially suitable for machine vision applications such as industrial inspection, medical, scientific research, education, security and so on.

The MERCURY GigE series camera is a compact camera that will be a good choice for the users who are demanding on the camera size. This manual describes in detail on how to install and use the MERCURY GigE digital cameras.

Contents

1. Introduction	1
1.1. Series Introduction	1
1.2. Naming Rules.....	1
1.3. Standards.....	1
1.4. Document, CAD / Technical Drawing and Software Downloads.....	2
2. Precautions	3
2.1. Guidelines for Avoiding EMI and ESD	3
2.2. Environmental Requirements	3
2.3. Camera Mechanical Installation Precautions.....	3
2.4. Certification and Declaration	4
3. Installation Guidelines	5
3.1. Host Preparation	5
3.1.1. Software Package	5
3.1.2. User Software Interface.....	5
3.2. Camera Power	6
3.3. Camera Driver Installation	7
3.3.1. System Requirements	7
3.3.2. Driver Installation.....	7
3.4. Camera IP Configuration	8
3.5. Open Device and Start Acquisition	8
4. General Specifications	10
4.1. Explanation of Important Parameters	10
4.1.1. About Spectral Response.....	10
4.2. MER-030-120GC / MER-030-120GM.....	10
4.2.1. Parameters	10
4.2.2. Spectral Response	11
4.3. MER-030-120GC-P / MER-030-120GM-P.....	12
4.3.1. Parameters	12
4.3.2. Spectral Response	13
4.4. MER-031-300GC / MER-031-300GM.....	14
4.4.1. Parameters	14
4.4.2. Spectral Response	15
4.5. MER-031-300GC-P / MER-031-300GM-P.....	15
4.5.1. Parameters	15
4.5.2. Spectral Response	16
4.6. MER-031-300GM-P NIR.....	17
4.6.1. Parameters	17

4.6.2. Spectral Response	18
4.7. MER-032-120GC / MER-032-120GM.....	18
4.7.1. Parameters	18
4.7.2. Spectral Response	19
4.8. MER-032-120GC-P / MER-032-120GM-P.....	20
4.8.1. Parameters	20
4.8.2. Spectral Response	21
4.9. MER-041-302GC / MER-041-302GM.....	22
4.9.1. Parameters	22
4.9.2. Spectral Response	23
4.10. MER-041-302GC-P / MER-041-302GM-P.....	24
4.10.1. Parameters	24
4.10.2. Spectral Response	25
4.11. MER-050-200GC / MER-050-200GM.....	26
4.11.1. Parameters	26
4.11.2. Spectral Response	27
4.12. MER-050-200GC-P / MER-050-200GM-P.....	27
4.12.1. Parameters	27
4.12.2. Spectral Response	28
4.13. MER-050-200GM-P NIR.....	29
4.13.1. Parameters	29
4.13.2. Spectral Response	30
4.14. MER-051-120GC / MER-051-120GM.....	30
4.14.1. Parameters	30
4.14.2. Spectral Response	31
4.15. MER-051-120GC-P / MER-051-120GM-P.....	32
4.15.1. Parameters	32
4.15.2. Spectral Response	33
4.16. MER-125-30GC / MER-125-30GM.....	33
4.16.1. Parameters	33
4.16.2. Spectral Response	34
4.17. MER-125-30GC-P / MER-125-30GM-P.....	35
4.17.1. Parameters	35
4.17.2. Spectral Response	36
4.18. MER-130-30GM	37
4.18.1. Parameters	37
4.18.2. Spectral Response	38
4.19. MER-131-75GC / MER-131-75GM.....	39
4.19.1. Parameters	39
4.19.2. Spectral Response	40
4.20. MER-131-75GC-P / MER-131-75GM-P.....	40
4.20.1. Parameters	40

4.20.2. Spectral Response	41
4.21. MER-131-75GM-P NIR.....	42
4.21.1. Parameters	42
4.21.2. Spectral Response	43
4.22. MER-132-30GC / MER-132-30GM.....	43
4.22.1. Parameters	43
4.22.2. Spectral Response	45
4.23. MER-132-43GC / MER-132-43GM.....	46
4.23.1. Parameters	46
4.23.2. Spectral Response	47
4.24. MER-132-43GC-P / MER-132-43GM-P.....	48
4.24.1. Parameters	48
4.24.2. Spectral Response	49
4.25. MER-133-54GC / MER-133-54GM.....	50
4.25.1. Parameters	50
4.25.2. Spectral Response	51
4.26. MER-133-54GC-P / MER-133-54GM-P.....	52
4.26.1. Parameters	52
4.26.2. Spectral Response	53
4.27. MER-200-14GC / MER-200-14GM.....	54
4.27.1. Parameters	54
4.27.2. Spectral Response	55
4.28. MER-200-20GC / MER-200-20GM.....	56
4.28.1. Parameters	56
4.28.2. Spectral Response	57
4.29. MER-200-20GC-P / MER-200-20GM-P.....	58
4.29.1. Parameters	58
4.29.2. Spectral Response	59
4.30. MER-201-25GC / MER-201-25GM.....	60
4.30.1. Parameters	60
4.30.2. Spectral Response	61
4.31. MER-201-25GC-P / MER-201-25GM-P.....	62
4.31.1. Parameters	62
4.31.2. Spectral Response	63
4.32. MER-203-30GC-P-L / MER-203-30GC-P-L-F03	64
4.32.1. Parameters	64
4.32.2. Spectral Response	65
4.33. MER-204-30GC-P-L-F02.....	65
4.33.1. Parameters	65
4.33.2. Spectral Response	66
4.34. MER-231-41GC / MER-231-41GM.....	67
4.34.1. Parameters	67

4.34.2. Spectral Response	68
4.35. MER-231-41GC-P / MER-231-41GM-P	69
4.35.1. Parameters	69
4.35.2. Spectral Response	70
4.36. MER-232-48GM-P NIR	71
4.36.1. Parameters	71
4.36.2. Spectral Response	72
4.37. MER-500-14GC / MER-500-14GM	73
4.37.1. Parameters	73
4.37.2. Spectral Response	74
4.38. MER-500-14GC-P / MER-500-14GM-P	75
4.38.1. Parameters	75
4.38.2. Spectral Response	76
4.39. MER-503-20GC / MER-503-20GM	77
4.39.1. Parameters	77
4.39.2. Spectral Response	78
4.40. MER-503-20GC-P / MER-503-20GM-P	79
4.40.1. Parameters	79
4.40.2. Spectral Response	80
4.41. MER-504-10GC-P / MER-504-10GM-P	81
4.41.1. Parameters	81
4.41.2. Spectral Response	82
4.42. MER-530-20GM-P NIR	83
4.42.1. Parameters	83
4.42.2. Spectral Response	84
4.43. MER-531-20GC-P / MER-531-20GM-P	84
4.43.1. Parameters	84
4.43.2. Spectral Response	85
4.44. MER-630-16GC / MER-630-16GM	86
4.44.1. Parameters	86
4.44.2. Spectral Response	87
4.45. MER-630-16GC-P / MER-630-16GM-P	88
4.45.1. Parameters	88
4.45.2. Spectral Response	89
4.46. MER-1070-10GC / MER-1070-10GM	90
4.46.1. Parameters	90
4.46.2. Spectral Response	91
4.47. MER-1070-10GC-P / MER-1070-10GM-P	92
4.47.1. Parameters	92
4.47.2. Spectral Response	93
4.48. MER-1220-9GC / MER-1220-9GM	94
4.48.1. Parameters	94

4.48.2. Spectral Response	95
4.49. MER-1220-9GC-P / MER-1220-9GM-P	96
4.49.1. Parameters	96
4.49.2. Spectral Response	97
4.50. MER-1520-7GC.....	98
4.50.1. Parameters	98
4.50.2. Spectral Response	99
4.51. MER-1520-7GC-P	99
4.51.1. Parameters	99
4.51.2. Spectral Response	100
4.52. MER-2000-5GC / MER-2000-5GM.....	101
4.52.1. Parameters	101
4.52.2. Spectral Response	102
4.53. MER-2000-5GC-P / MER-2000-5GM-P	103
4.53.1. Parameters	103
4.53.2. Spectral Response	104
5. Dimensions	105
5.1. Camera Dimensions	105
5.2. Optical Interface	106
5.3. Tripod Adapter Dimensions	106
6. Filters and Lenses	108
6.1. Filters	108
6.2. Lens Selection Reference	109
6.2.1. HN-2M Series	110
6.2.2. HN-5M Series	111
6.2.3. HN-6M Series	111
6.2.4. HN-20M Series	112
6.2.5. HN-P-6M Series	113
6.2.6. HN-P-10M Series	113
6.2.7. HN-P-25M Series	114
7. Electrical Interface.....	115
7.1. LED Light.....	115
7.2. Ethernet Port	115
7.3. I/O Port.....	115
7.3.1. Line0 (Opto-isolated Input) Circuit	116
7.3.2. Line1 (Opto-isolated Output) Circuit.....	118
7.3.3. GPIO 2/3 (Bidirectional) Circuit	120
7.3.3.1. Line2/3 is Configured as Input.....	120
7.3.3.2. Line2/3 is Configured as Output.....	122
8. Features.....	124

8.1. I/O Control	124
8.1.1. Input Mode Operation	124
8.1.2. Output Mode Operation	125
8.1.3. Read the LineStatus	126
8.2. Image Acquisition Control	127
8.2.1. Acquisition Start and Stop	127
8.2.1.1. Acquisition Start	127
8.2.1.2. Acquisition Stop	128
8.2.2. Switching Acquisition Mode	129
8.2.3. Continuous Mode and Configuration	130
8.2.4. Software Trigger Acquisition and Configuration	130
8.2.5. Hardware Trigger Acquisition and Configuration	131
8.2.6. Set Exposure	135
8.2.7. Overlap Exposure and Non-overlap Exposure	139
8.3. Basic Features	141
8.3.1. Gain	141
8.3.2. Pixel Format	144
8.3.3. ROI	149
8.3.4. Auto Exposure/Auto Gain	149
8.3.4.1. ROI Setting of Auto Exposure/ Auto Gain	149
8.3.4.2. Auto Gain	151
8.3.4.3. Auto Exposure	151
8.3.5. Auto White Balance	151
8.3.5.1. Auto White Balance ROI	151
8.3.5.2. Auto White Balance Adjustment	153
8.3.6. Lookup Table	153
8.3.7. Test Pattern	154
8.3.8. User Set Control	156
8.3.9. Device User ID	158
8.4. Image Processing	159
8.4.1. HDR	159
8.5. Image Transmission	159
8.5.1. Maximum Allowable Frame Rate	159
8.5.2. Stream Channel Packet Size	166
8.5.3. Stream Channel Packet Delay	167
8.5.4. Bandwidth Reserve	168
8.5.5. Frame Transfer Control	168
8.6. Events	168
8.6.1. ExposureEnd Event	169
8.6.2. BlockDiscard Event	169
8.6.3. BlockNotEmpty Event	170
8.6.4. FrameStartOvertrigger Event	170

8.6.5. EventOverrun Event	170
9. Software Tools	171
9.1. GigE IP Configurator	171
9.1.1. GUI.....	171
9.1.2. User Guide.....	172
9.1.2.1. Refresh Devices.....	172
9.1.2.2. Auto Config	173
9.1.2.3. Display Information	174
9.1.2.4. Configure IP Address	174
9.1.2.5. IP Configuration Mode	175
9.1.2.6. Change the Device User ID	176
9.1.2.7. Reset Device and Reconnect Device	176
9.1.3. Precautions.....	176
9.1.3.1. Check IP Address Format.....	176
9.1.3.2. Length Limitation of User-defined Name	177
9.1.3.3. Tips.....	177
9.2. Frame Rate Calculation Tool	178
10. FAQ	180
11. Revision History	182
12. Contact Us.....	184
12.1. Contact Sales	184
12.2. Contact Support	184

1. Introduction

1.1. Series Introduction

The MERCURY GigE series (MER-G and MER-G-P) camera is DAHENG IMAGING's mature area scan industrial digital camera, featuring outstanding performance, powerful features and outstanding price/performance ratio. The MER-G-P camera supports Power over Ethernet (PoE, IEEE802.3af compliant), which is easy to install and use. The MER-G and MER-G-P series cameras are available in a variety of resolutions and frame rates, and are available with CCD or CMOS sensors from leading chip manufacturers.

The MER-G and MER-G-P series digital camera transmits image data through the GigE interface. Thanks to the locking screw connectors, the MERCURY series cameras can secure the reliability of cameras deployed in harsh industrial environments. Featuring high reliability and high price/performance ratio, the MERCURY series cameras are especially suitable for machine vision applications such as industrial inspection, medical, scientific research, education, security and so on.

1.2. Naming Rules

Details of the MERCURY GigE series camera is given in the general specifications below. Each camera model name is determined by its sensor's maximum resolution, maximum frame rate at maximum resolution, the color/monochrome type of the sensor, etc.

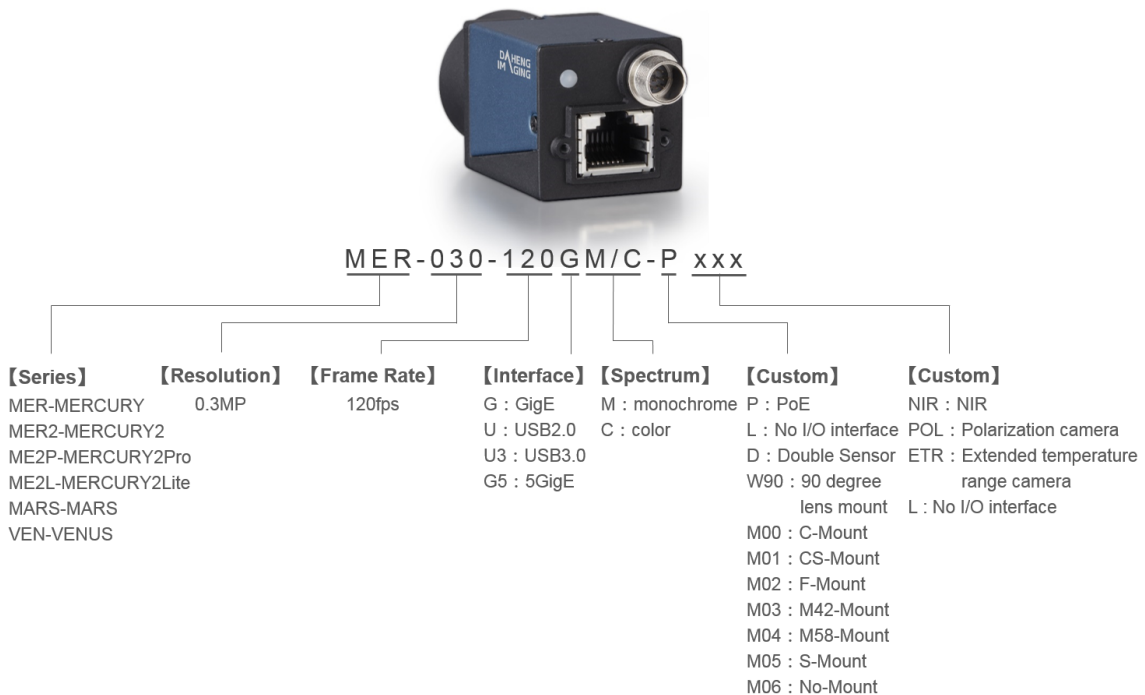

Figure 1-1 Naming rules

1.3. Standards

The camera follows the GigE Vision 1.2 standard, the GEN<i>CAM3.0 standard and the IEEE802.3af standard.

1.4. Document, CAD / Technical Drawing and Software Downloads

Product related document, CAD/Technical drawing and software can be downloaded from the [Downloads](#) of DAHENG IMAGING website. The relevant contents are as follows:

Document	DAHENG IMAGING MERCURY Programming Guide
	MERCURY GigE/USB3.0/USB2.0 Cameras User Manual
CAD/Technical Drawing	DAHENG IMAGING MER-G/ MER-GM/C-P/ MER-U3/ MER-U3-L/ MER-U2/ MER-U2-L CAD/Technical Drawing
Software	Galaxy Windows SDK—USB3.0, GigE, GigE, MERCURY USB2.0 Cameras
	Galaxy Linux SDK—USB3.0, GigE, GigE, MERCURY USB2.0 Cameras

2. Precautions

2.1. Guidelines for Avoiding EMI and ESD

- 1) CAT-5e cables or above with S/STP shielding are recommended.
- 2) Using shielded cable can avoid electro-magnetic interface. Shielding layer of the cable should conduct to ground nearby and not until stretched too long. When many devices need conduct to ground, using single point grounding to avoid earth loop.
- 3) Try to use camera cables that are the correct length. Avoid coiling camera cables. If the cables are too long, use a meandering path rather than coiling the cables.
- 4) Keep your cameras away from equipment with high voltage, or high current (as motor, inverter, relay, etc.). If necessary, use additional shielding.
- 5) ESD (electro-static discharge) may damage cameras permanently, so use suitable clothing (cotton) and shoes, and touch the metal to discharge the electro-static before operating cameras.

2.2. Environmental Requirements

- 1) Housing temperature during operation: 0°C ~ 45°C, humidity during operation: 10% ~ 80%.
Storage temperature: -20°C ~ 70°C.
- 2) To avoid collecting dust in the optical filter, always keep the plastic cap on cameras when no lens is mounted.
- 3) PC requirement: Intel Core 2 Duo, 2.4GHz or above, 2GB memory or above.
- 4) NIC requirement: Intel Pro 1000 NIC confirming to IEEE802.3af standard or higher performance Intel GigE NIC, CAT-5e cables or above, length less than 100m, switch confirming to IEEE802.3af standard.
- 5) Make sure that cameras are transported in the original factory packages.

2.3. Camera Mechanical Installation Precautions

1. Camera installation requirements
 - 1) The screw and camera have a screw length between 2.5 and 2.7 mm.
 - 2) Screw assembly torque $\leq 1\text{N.M}$. If the screw assembly torque is too large, it may cause the camera thread stripping.
2. DAHENG tripod adapter instructions
 - 1) M3 * 6 cross recessed cheese head screws are required.
 - 2) After the screws pass through the tripod adapter, they are directly assembled with the camera threads.

3) DAHENG tripod adapter does not need to use spring washer.

2.4. Certification and Declaration

1. CE, RoHS

We declare that DAHENG IMAGING MERCURY GigE digital cameras have passed the following EU certifications:

- 2014/30/EU—Electromagnetic Compatibility Restriction
- 2011/65/EU—Restriction of Hazardous Substances (RoHS) and its revised directive 2015/863/EU



Operation of this equipment in a residential environment could cause radio interference.

2. FCC

The MERCURY GigE digital camera has been tested and found to comply with the limits for a Class B digital device, pursuant to Part 15 of the FCC Rules. These limits are designed to provide reasonable protection against harmful interference when the equipment is operated in a residential area. This equipment may generate or radiate radio frequency energy. If it is not installed and used in accordance with the instructions, it may cause harmful interference to radio communications, but there is no guarantee that interference will not occur in a particular installation environment. If the equipment does cause harmful interference to radio or television reception, which can be determined by opening or closing the equipment, the user is recommended to take one or more of the following measures to eliminate interference:

- Adjust the direction or position of the receiving antenna
- Increase the separation between the equipment and receiver
- Connect the equipment and receiver to different circuits
- Consult dealers or experienced engineers for help

Changes or modifications to the product without the authorization from DAHENG IMAGING may invalidate the FCC certification and lose the warranty qualification of the product.

3. Installation Guidelines

3.1. Host Preparation

3.1.1. Software Package

The software package of DAHENG IMAGING's MERCURY series is used to control the MERCURY series camera to provide stable, real-time image transmission, and provides a free SDK and abundant development sample source code. The package is composed of the following modules:

- 1) Driver Package (Driver): This package provides the MERCURY series camera driver program, such as: the GigE Vision cameras' Filter Driver Program.
- 2) Interface Library (API): This package provides the camera control interface library and the image processing interface library, supports the user for secondary development.
- 3) Demonstration Program (GalaxyView.exe): This demonstration program is used to display the camera control, image acquisition and image processing functions, the user can control the camera directly by the demonstration program, and the user can develop their own control program based on the camera interface library.
- 4) IP configurator (GxGigeIPConfig.exe): The tool is used to configure the camera IP address and to set the IP mode when the camera is powered on.
- 5) Sample: These samples demonstrate cameras' functions, the user can easily use these samples to control cameras, or refer to the samples to develop their own control programs.
- 6) Programmer's Manual: This manual is the users programming guide that instructs the users how to configure the programming environment and how to control cameras and acquisition images through the camera interface library.

You can download the latest software package from the website: www.daheng-imaging.com/en/Downloads.

3.1.2. User Software Interface

After installing the MERCURY series camera software package, the user can use the demonstration program and the samples to control the camera, also the user can control the camera by the program which is written by the user themselves. The software package provides three kinds of program interface, the user can select the suitable one for use according to their own requirements:

1) API Interface

In order to simplify the users' programming complexity, the package provides the general C programming interface GxIAPI.dll and image processing algorithm interface DxImageProc.dll for the user to control the camera, and provides the samples and software development manual which are based on these interfaces. The API interface supports C/C++/C#/Python, etc.

2) GenTL Interface

This interface is developed according to the standard of general transport layer in Gen<i>Cam standard, DAHENG IMAGING follows the Gen<i>Cam standard and provides the GenTL interface for the user, the user can use the GenTL interface directly to develop their own control program. The definition and usage of GenTL interfaces can be downloaded from the website of EMVA.

In addition, users can use some third-party software that supports Gen< i >Cam standard to control the camera, such as HALCON.

3) GigE Vision interface

The MERCURY series GigE Vision camera is compatible with the GigE Vision protocol, which allows the user to control the camera directly through the GigE Vision protocol. In addition, the user can use some third-party software that supports the GigE Vision protocol to control the camera, such as HALCON.

● **Note**

GEN<i>CAM standard: GEN<i>CAM is administered by the European Machine Vision Association (EMVA). GenICam provides a generic programming interface for all kinds of cameras and devices. It provides a standard application programming interface (API), no matter what interface technology is being used. It mainly includes the following modules:

- GenAPI: an XML description file format defining how to capture the features of a device and how to access and control these features in a standard way
- GenTL: a generic Transport Layer Interface, between software drivers and libraries, that transports the image data from the camera to the application running on a PC
- SFNC: common naming convention for camera features, which promotes interoperability between products from different manufacturers

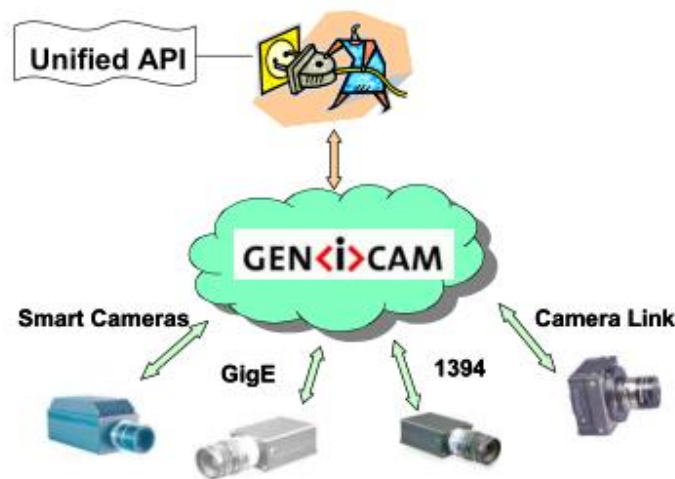

Figure 3-1 GEN<i>CAM standard schematic diagram

3.2. Camera Power

The MER-G-P series camera can get power in either of two different ways: via PoE (Power over Ethernet) or via Hirose I/O port. The MER-G-P series cameras can be powered in one way: via Hirose I/O port.

1) Via PoE (Power over Ethernet)

Via PoE (Power over Ethernet), i.e., via the Ethernet cable plugged into the camera's RJ45 jack. Use the IEEE 802.3af compliant PSE (Power sourcing equipment) to power the MER-G-P camera.

2) Via the Hirose I/O port

The MER-G-P camera can get power from the 8-pin Hirose I/O port via a standard I/O cable.

Nominal operating voltage is +12V (± 10%).

When you supply power to the MER-G-P camera both via the camera's RJ45 jack and via the 8-pin Hirose I/O port, the camera will get power via the Hirose I/O port. And if you cut off the Hirose I/O port, the camera will get power via PoE and may restart.

- 1) Voltage outside of the specified range can cause damage.
- 2) The plug on the cable that you attach to the 8-pin Hirose I/O port must have 8 female pins. Using a plug designed for a smaller or a larger number of pins can damage the connector. See section 7.3 for the definition of IO port.
- 3) The MER-G camera can only be powered via the IO port and cannot be powered via PoE. IO port power supply mode is the same as MER-G-P camera.



3.3. Camera Driver Installation

3.3.1. System Requirements

GalaxySDK is suitable for all cameras in the MERCURY series. The GalaxySDK contains various operating systems such as Windows and Linux. The requirements for the operating system and version of the installation package are as follows:

Operating Systems	Applicable Version
Windows	<ul style="list-style-type: none"> ➤ Windows XP (32bit, 64bit) ➤ Windows 7 (32bit, 64bit) ➤ Windows 8 (32bit, 64bit) ➤ Windows 8.1 (32bit, 64bit) ➤ Windows 10 (32bit, 64bit)
Linux	<ul style="list-style-type: none"> ➤ Ubuntu 12.04 or above, kernel version 3.5.0.23 or above
Android	<ul style="list-style-type: none"> ➤ Android 6 or above

3.3.2. Driver Installation

The steps to install the GalaxySDK under Windows are as follows:

- 1) Download the corresponding version of the installation package from www.daheng-imaging.com/en/Downloads.

- 2) Run the installer.
- 3) Follow the instructions of the installation wizard to complete the installation process. During the installation process, you can choose the camera interface you need (USB2.0, USB3 Vision, GigE Vision, etc.).

During the installation process, especially when installing *.sys files, you must always pay attention to the anti-virus software to intercept the driver. If intercepted, it may cause the driver installation to fail.

3.4. Camera IP Configuration

The IP Configurator provided by GalaxySDK eliminates the need for users to configure IP for hosts and devices. Implement one-click configuration IP. You only need to follow the steps below to configure the camera IP. For details on how to use the tool, please refer to section 9.1.

- 1) Connect the GigE camera to the network port of the current host.
- 2) Open the GigE IP Configurator of the installation package.
- 3) Click "Auto Config" on the right side of the GigE IP Configurator to automatically configure the IP.

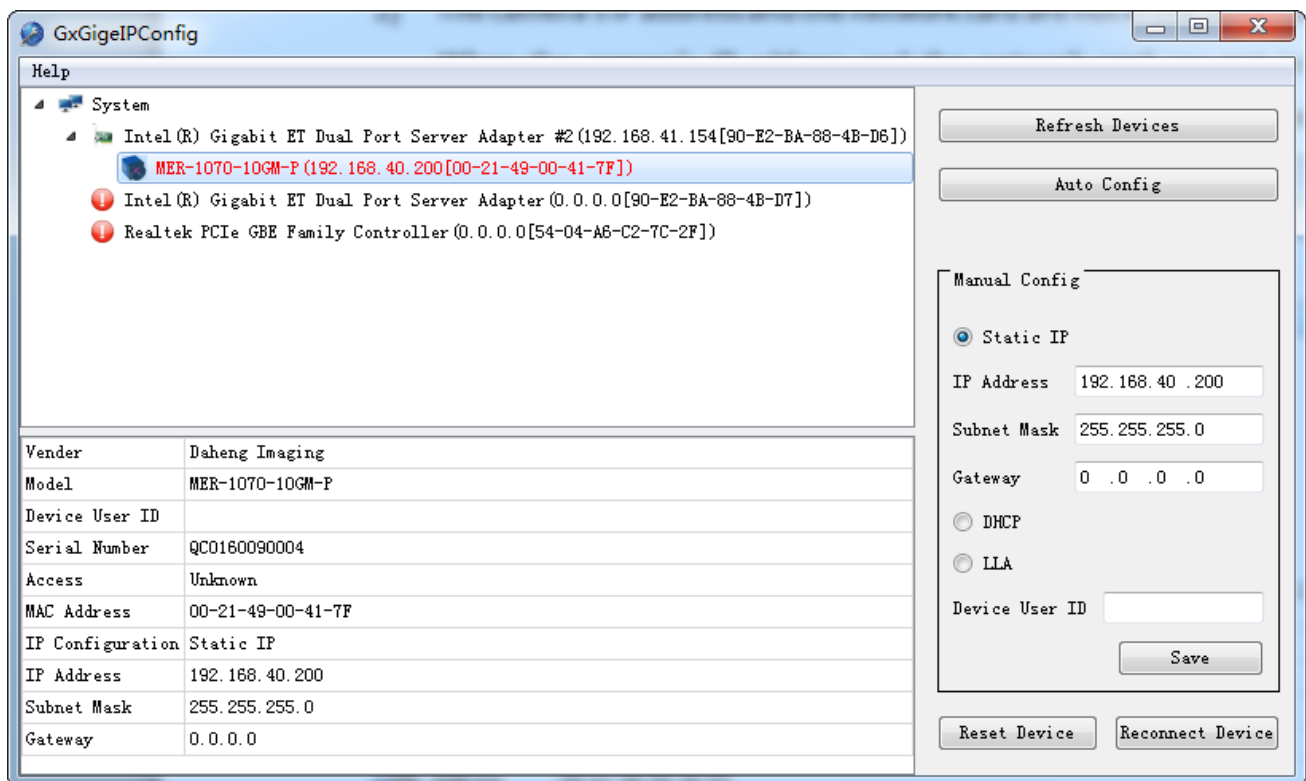



Figure 3-2 GigE IP Configurator

3.5. Open Device and Start Acquisition

After powering the device, connecting the device to the host, and configuring the IP, you can double-click the GalaxyView software to acquire image. The steps are as follows:

- 1) Click the  icon on the Toolbar in the GalaxyView to refresh device list.
- 2) After the device is enumerated, double-click the device enumerated in the device list.
- 3) Click the  icon on the Toolbar to perform the Start Acquisition operation on the current device.

4. General Specifications

4.1. Explanation of Important Parameters

4.1.1. About Spectral Response

QE: Quantum efficiency, which is the ratio of the average number of photoelectrons produced per unit time at a wavelength to the number of incident photons.

Sensitivity: The change of the sensor output signal relative to the incident light energy. The commonly used sensitivity units are $V/((W/m^2) \cdot s)$, $V/lux \cdot s$, $e^-/((W/m^2) \cdot s)$ or $DN/((W/m^2) \cdot s)$.

The spectral response graph given by different manufacturers are different. Some graphs' ordinate is relative sensitivity response, and abscissa is wavelength. Some graphs' ordinate is QE, and abscissa is wavelength.

4.2. MER-030-120GC / MER-030-120GM

4.2.1. Parameters

Specifications	MER-030-120GC	MER-030-120GM
Resolution	656x492	
Sensor Type	Sony ICX618 AL/AQ global shutter CCD	
Max. Image Circle	1/4 inch	
Pixel Size	5.6 μ m \times 5.6 μ m	
Frame Rate	120fps@656x492	
ADC Bit Depth	12bit	
Pixel Bit Depth	8bit, 12bit	
Shutter Time	4 μ s~1s	
Gain	0dB~25dB	
Pixel Formats	Bayer RG8/Bayer RG12	Mono8/Mono12
Signal Noise Ratio	42.85dB	43.21dB
Synchronization	Hardware trigger, software trigger	
I/O	1 opto-isolated input line and 1 opto-isolated output line, 2 GPIOs	
Operating Temp.	0 $^{\circ}$ C~45 $^{\circ}$ C	
Storage Temp.	-20 $^{\circ}$ C~70 $^{\circ}$ C	

Operating Humidity	10%~80%
Power Consumption	<3W@12V
Lens Mount	C
Dimensions	29mm×29mm×29mm (without lens adapter or connectors)
Weight	60g
Operating System	Windows XP / Win7 / Win8 / Win8.1 / Win10 / Windows Embedded 32bit and 64bit OS, Ubuntu14.04 / Ubuntu16.04 Linux OS
Data Interface	Fast Ethernet (100Mbit/s) or Gigabit Ethernet (1000Mbit/s)
Programmable Control	Image size, gain, Exposure time, trigger polarity, flash polarity
Conformity	CE, RoHS, FCC, GigE Vision, GenICam

4.2.2. Spectral Response

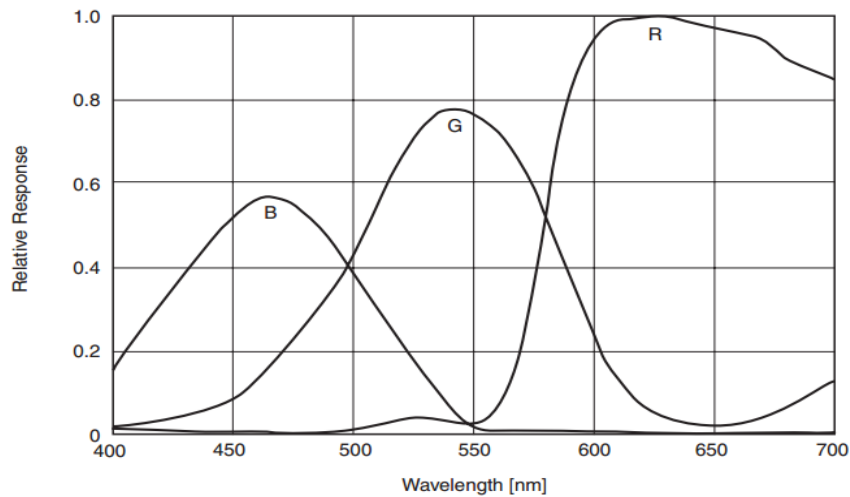

Figure 4-1 MER-030-120GC sensor spectral response

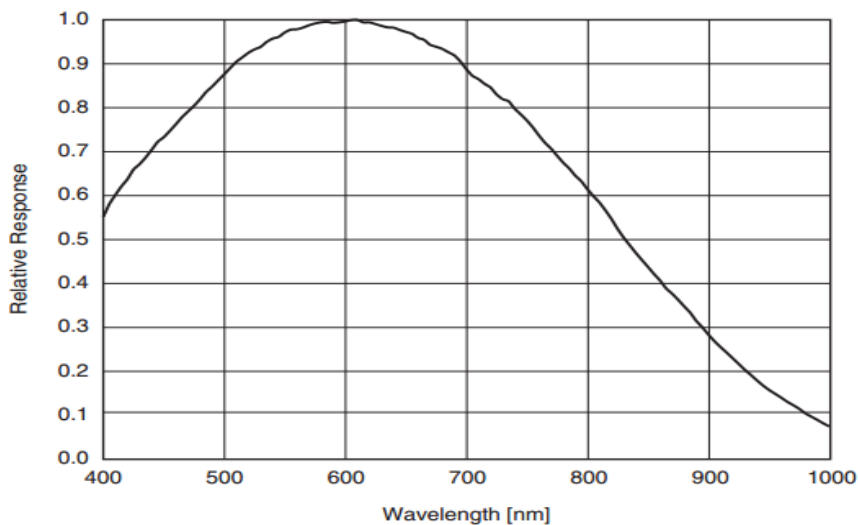

Figure 4-2 MER-030-120GM sensor spectral response

4.3. MER-030-120GC-P / MER-030-120GM-P

4.3.1. Parameters

Specifications	MER-030-120GC-P	MER-030-120GM-P
Resolution	656x492	
Sensor Type	Sony ICX618 AL/AQ global shutter CCD	
Max. Image Circle	1/4 inch	
Pixel Size	5.6μm×5.6μm	
Frame Rate	120fps@656x492	
ADC Bit Depth	12bit	
Pixel Bit Depth	8bit, 12bit	
Shutter Time	4μs~1s	
Gain	0dB~25dB	
Pixel Formats	Bayer RG8/Bayer RG12	Mono8/Mono12
Signal Noise Ratio	42.89dB	42.9dB
Synchronization	Hardware trigger, software trigger	
I/O	1 opto-isolated input line and 1 opto-isolated output line, 2 GPIOs	
Operating Temp.	0°C~45°C	
Storage Temp.	-20°C~70°C	
Operating Humidity	10%~80%	
Camera Power Requirements	PoE (Power over Ethernet, 802.3af compliant) or +12 VDC (± 10%), supplied via the camera's 8-pin Hirose connector	
Power Consumption	<3W@12VDC, <3.75W@PoE	
Lens Mount	C	
Dimensions	38.3mm×29mm×29mm (without lens adapter or connectors)	

Weight	75g
Operating System	Windows XP / Win7 / Win8 / Win8.1 / Win10 / Windows Embedded 32bit and 64bit OS, Ubuntu14.04 / Ubuntu16.04 Linux OS
Data Interface	Fast Ethernet (100Mbit/s) or Gigabit Ethernet (1000Mbit/s)
Programmable Control	Image size, gain, Exposure time, trigger polarity, flash polarity
Conformity	CE, RoHS, FCC, GigE Vision, GenICam, IEEE802.3af

4.3.2. Spectral Response

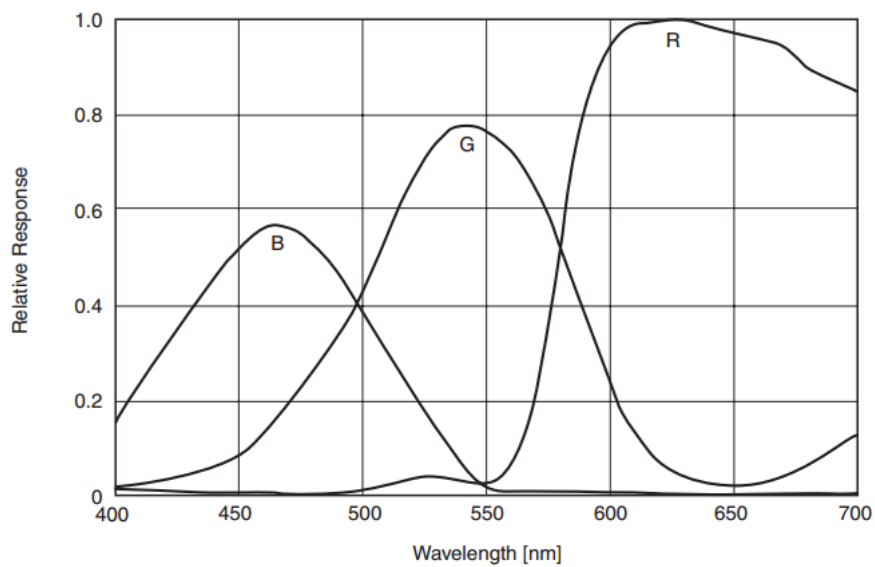

Figure 4-3 MER-030-120GC-P sensor spectral response

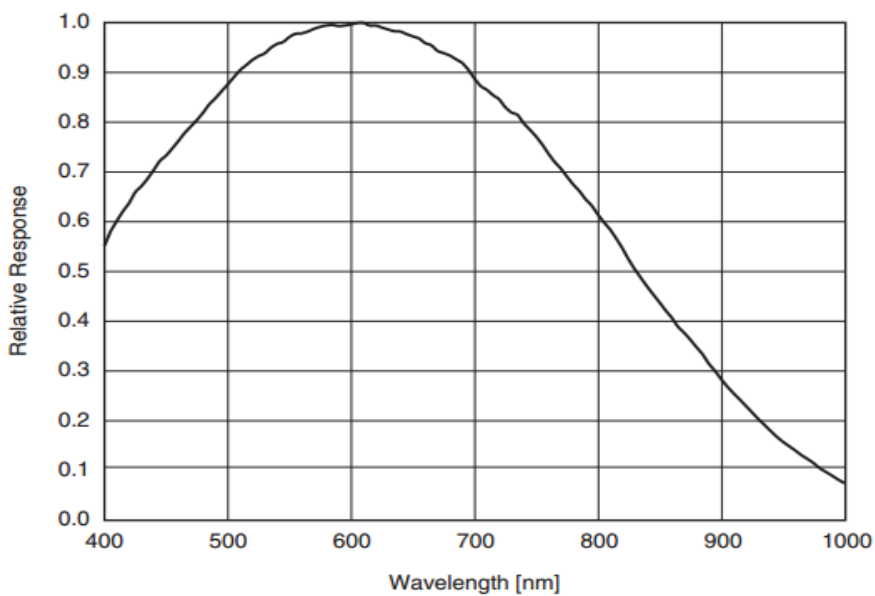

Figure 4-4 MER-030-120GM-P sensor spectral response

4.4. MER-031-300GC / MER-031-300GM

4.4.1. Parameters

Specifications	MER-031-300GC	MER-031-300GM
Resolution	640×480	
Sensor Type	ON PYTHON 300 global shutter CMOS	
Max. Image Circle	1/4 inch	
Pixel Size	4.8μm×4.8μm	
Frame Rate	300fps@640×480	
ADC Bit Depth	10bit	
Pixel Bit Depth	8bit, 10bit	
Shutter Time	20μs~1s	
Gain	0dB~16dB	
Pixel Formats	Bayer RG8/Bayer RG10	Mono8/Mono10
Signal Noise Ratio	38.29dB	38.33dB
Synchronization	Hardware trigger, software trigger	
I/O	1 opto-isolated input line and 1 opto-isolated output line, 2 GPIOs	
Operating Temp.	0°C~45°C	
Storage Temp.	-20°C~70°C	
Operating Humidity	10%~80%	
Power Consumption	<3W@12V	
Lens Mount	C	
Dimensions	29mm×29mm×29mm (without lens adapter or connectors)	
Weight	60g	
Operating System	Windows XP / Win7 / Win8 / Win8.1 / Win10 / Windows Embedded 32bit and 64bit OS, Ubuntu14.04 / Ubuntu16.04 Linux OS	
Data Interface	Fast Ethernet (100Mbit/s) or Gigabit Ethernet (1000Mbit/s)	

Programmable Control	Image size, gain, Exposure time, trigger polarity, flash polarity
Conformity	CE, RoHS, FCC, GigE Vision, GenICam

4.4.2. Spectral Response

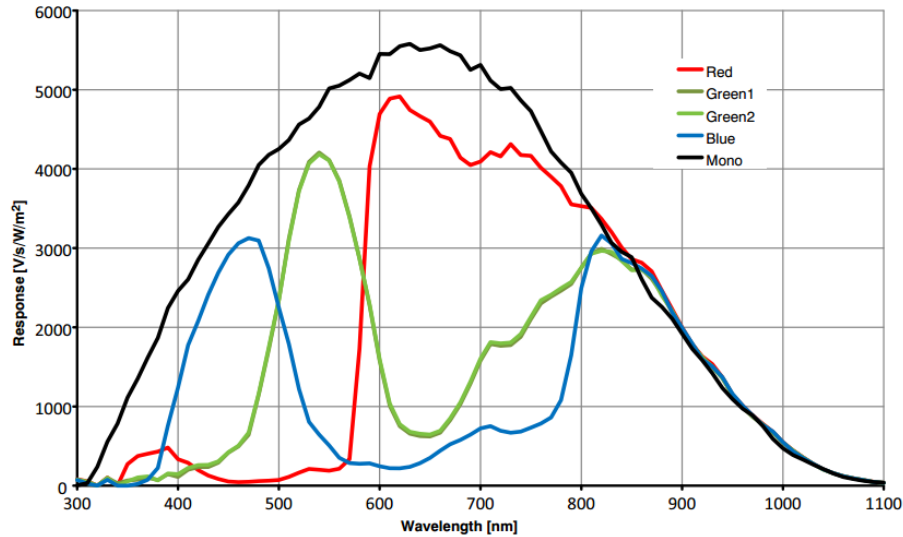

Figure 4-5 MER-031-300GC / MER-031-300GM sensor spectral response

4.5. MER-031-300GC-P / MER-031-300GM-P

4.5.1. Parameters

Specifications	MER-031-300GC-P	MER-031-300GM-P
Resolution	640x480	
Sensor Type	ON PYTHON 300 global shutter CMOS	
Max. Image Circle	1/4 inch	
Pixel Size	4.8μm×4.8μm	
Frame Rate	300fps@640x480	
ADC Bit Depth	10bit	
Pixel Bit Depth	8bit, 10bit	
Shutter Time	20μs~1s	
Gain	0dB~16dB	
Pixel Formats	Bayer RG8/Bayer RG10	Mono8/Mono10

Signal Noise Ratio	38.45dB	38.52dB
Synchronization	Hardware trigger, software trigger	
I/O	1 opto-isolated input line and 1 opto-isolated output line, 2 GPIOs	
Operating Temp.	0°C~45°C	
Storage Temp.	-20°C~70°C	
Operating Humidity	10%~80%	
Camera Power Requirements	PoE (Power over Ethernet, 802.3af compliant) or +12 VDC (± 10%), supplied via the camera's 8-pin Hirose connector	
Power Consumption	<3W@12VDC, <3.75W@PoE	
Lens Mount	C	
Dimensions	38.3mm×29mm×29mm (without lens adapter or connectors)	
Weight	75g	
Operating System	Windows XP / Win7 / Win8 / Win8.1 / Win10 / Windows Embedded 32bit and 64bit OS, Ubuntu14.04 / Ubuntu16.04 Linux OS	
Data Interface	Fast Ethernet (100Mbit/s) or Gigabit Ethernet (1000Mbit/s)	
Programmable Control	Image size, gain, Exposure time, trigger polarity, flash polarity	
Conformity	CE, RoHS, FCC, GigE Vision, GenICam, IEEE802.3af	

4.5.2. Spectral Response

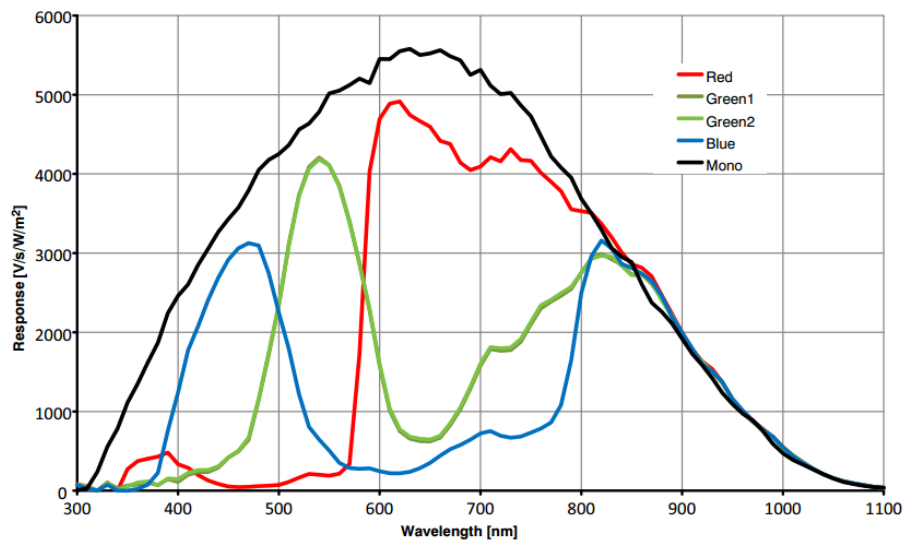

Figure 4-6 MER-031-300GC-P / MER-031-300GM-P sensor spectral response

4.6. MER-031-300GM-P NIR

4.6.1. Parameters

Specifications	MER-031-300GM-P NIR
Resolution	640×480
Sensor Type	ON PYTHON 300 global shutter CMOS
Max. Image Circle	1/4 inch
Pixel Size	4.8μm×4.8μm
Frame Rate	300fps@640×480
ADC Bit Depth	10bit
Pixel Bit Depth	8bit, 10bit
Shutter Time	20μs~1s
Gain	0dB~16dB
Pixel Formats	Mono8/Mono10
Signal Noise Ratio	37.94dB
Synchronization	Hardware trigger, software trigger
I/O	1 opto-isolated input line and 1 opto-isolated output line, 2 GPIOs
Operating Temp.	0°C~45°C
Storage Temp.	-20°C~70°C
Operating Humidity	10%~80%
Camera Power Requirements	PoE (Power over Ethernet, 802.3af compliant) or +12 VDC (± 10%), supplied via the camera's 8-pin Hirose connector
Power Consumption	<3W@12VDC, <3.75W@PoE
Lens Mount	C
Dimensions	38.3mm×29mm×29mm (without lens adapter or connectors)
Weight	75g
Operating System	Windows XP / Win7 / Win8 / Win8.1 / Win10 / Windows Embedded 32bit and 64bit OS, Ubuntu14.04 / Ubuntu16.04 Linux OS

Data Interface	Fast Ethernet (100Mbit/s) or Gigabit Ethernet (1000Mbit/s)
Programmable Control	Image size, gain, Exposure time, trigger polarity, flash polarity
Conformity	CE, RoHS, FCC, GigE Vision, GenICam, IEEE802.3af

4.6.2. Spectral Response

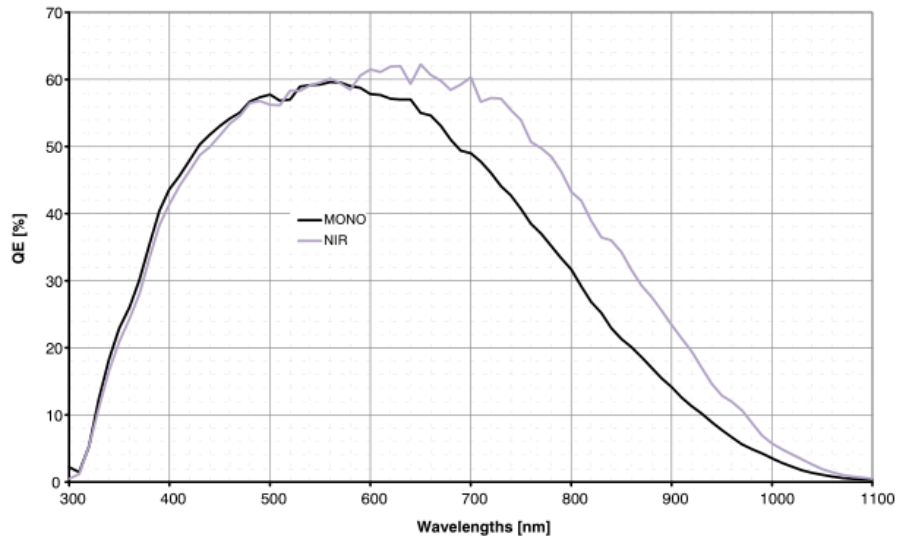

Figure 4-7 MER-031-300GM-P NIR sensor spectral response

4.7. MER-032-120GC / MER-032-120GM

4.7.1. Parameters

Specifications	MER-032-120GC	MER-032-120GM
Resolution	656x492	
Sensor Type	Global shutter CCD	
Max. Image Circle	1/3 inch	
Pixel Size	7.4μm×7.4μm	
Frame Rate	120fps@656x492	
ADC Bit Depth	12bit	
Pixel Bit Depth	8bit, 12bit	
Shutter Time	20μs~1s	
Gain	0dB~25dB	

Pixel Formats	Bayer RG8/Bayer RG12	Mono8/Mono12
Signal Noise Ratio	39.51dB	39.87dB
Synchronization	Hardware trigger, software trigger	
I/O	1 opto-isolated input line and 1 opto-isolated output line, 2 GPIOs	
Operating Temp.	0°C~45°C	
Storage Temp.	-20°C~70°C	
Operating Humidity	10%~80%	
Power Consumption	<3W@12V	
Lens Mount	C	
Dimensions	29mm×29mm×29mm (without lens adapter or connectors)	
Weight	60g	
Operating System	Windows XP / Win7 / Win8 / Win8.1 / Win10 / Windows Embedded 32bit and 64bit OS, Ubuntu14.04 / Ubuntu16.04 Linux OS	
Data Interface	Fast Ethernet (100Mbit/s) or Gigabit Ethernet (1000Mbit/s)	
Programmable Control	Image size, gain, Exposure time, trigger polarity, flash polarity	
Conformity	CE, RoHS, FCC, GigE Vision, GenICam	

4.7.2. Spectral Response

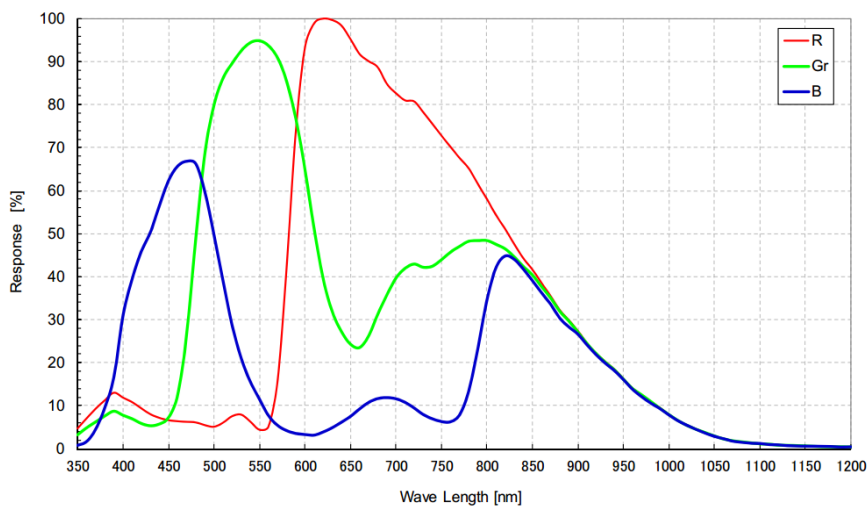

Figure 4-8 MER-032-120GC sensor spectral response

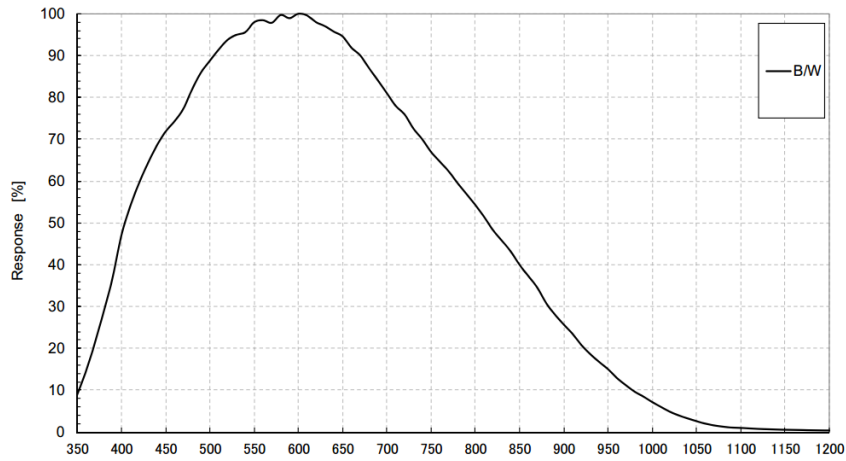

Figure 4-9 MER-032-120GM sensor spectral response

4.8. MER-032-120GC-P / MER-032-120GM-P

4.8.1. Parameters

Specifications	MER-032-120GC-P	MER-032-120GM-P
Resolution	656x492	
Sensor Type	Global shutter CCD	
Max. Image Circle	1/3 inch	
Pixel Size	7.4μm×7.4μm	
Frame Rate	120fps@656x492	
ADC Bit Depth	12bit	
Pixel Bit Depth	8bit, 12bit	
Shutter Time	20μs~1s	
Gain	0dB~25dB	
Pixel Formats	Bayer RG8/Bayer RG12	Mono8/Mono12
Signal Noise Ratio	39.38dB	39.9dB
Synchronization	Hardware trigger, software trigger	
I/O	1 opto-isolated input line and 1 opto-isolated output line, 2 GPIOs	
Operating Temp.	0°C~45°C	
Storage Temp.	-20°C~70°C	
Operating Humidity	10%~80%	

Camera Power Requirements	PoE (Power over Ethernet, 802.3af compliant) or +12 VDC ($\pm 10\%$), supplied via the camera's 8-pin Hirose connector
Power Consumption	<3W@12VDC, <3.75W@PoE
Lens Mount	C
Dimensions	38.3mm×29mm×29mm (without lens adapter or connectors)
Weight	75g
Operating System	Windows XP / Win7 / Win8 / Win8.1 / Win10 / Windows Embedded 32bit and 64bit OS, Ubuntu14.04 / Ubuntu16.04 Linux OS
Data Interface	Fast Ethernet (100Mbit/s) or Gigabit Ethernet (1000Mbit/s)
Programmable Control	Image size, gain, Exposure time, trigger polarity, flash polarity
Conformity	CE, RoHS, FCC, GigE Vision, GenICam, IEEE802.3af

4.8.2. Spectral Response

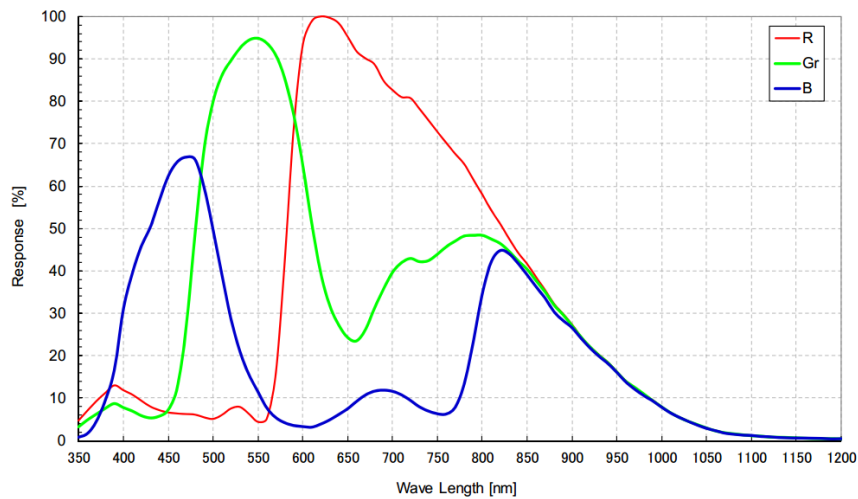

Figure 4-10 MER-032-120GC-P sensor spectral response

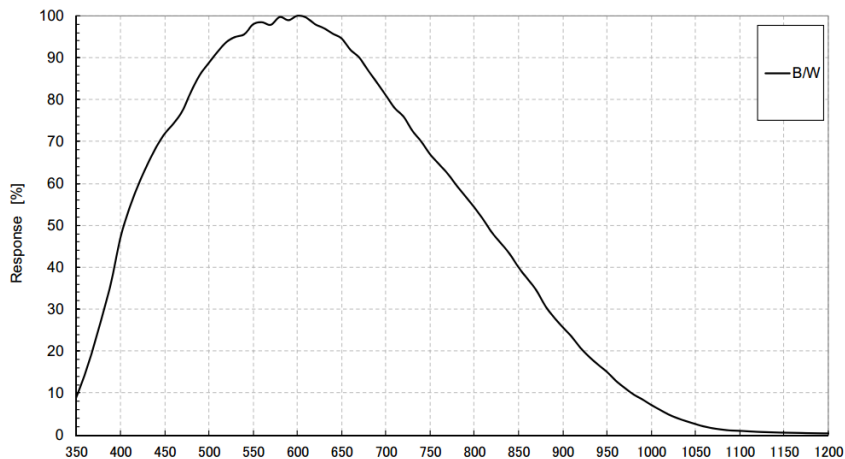

Figure 4-11 MER-032-120GM-P sensor spectral response

4.9. MER-041-302GC / MER-041-302GM

4.9.1. Parameters

Specifications	MER-041-302GC	MER-041-302GM
Resolution	720x540	
Sensor Type	Sony IMX287 global shutter CMOS	
Max. Image Circle	1/2.9 inch	
Pixel Size	6.90μm×6.90μm	
Frame Rate	Default:99.16fps@720x540 Higher frame rates (302fps) are possible if you change the Packet Size to 8192 and the Bandwidth Reserve to 5	
ADC Bit Depth	12bit	
Pixel Bit Depth	8bit, 12bit	
Shutter Time	20μs~1s	
Gain	0dB~24dB	
Pixel Formats	Bayer RG8/Bayer RG12	Mono8/Mono12
Signal Noise Ratio	43.27dB	43.39dB
Synchronization	Hardware trigger, software trigger	
I/O	1 opto-isolated input line and 1 opto-isolated output line, 2 GPIOs	
Operating Temp.	0°C~45°C	
Storage Temp.	-20°C~70°C	
Operating Humidity	10%~80%	
Power Consumption	<3W@12V	
Lens Mount	C	
Dimensions	29mm×29mm×29mm (without lens adapter or connectors)	

Weight	60g
Operating System	Windows XP / Win7 / Win8 / Win8.1 / Win10 / Windows Embedded 32bit and 64bit OS, Ubuntu14.04 / Ubuntu16.04 Linux OS
Data Interface	Fast Ethernet (100Mbit/s) or Gigabit Ethernet (1000Mbit/s)
Programmable Control	Image size, gain, Exposure time, trigger polarity, flash polarity
Conformity	CE, RoHS, FCC, GigE Vision, GenICam

4.9.2. Spectral Response

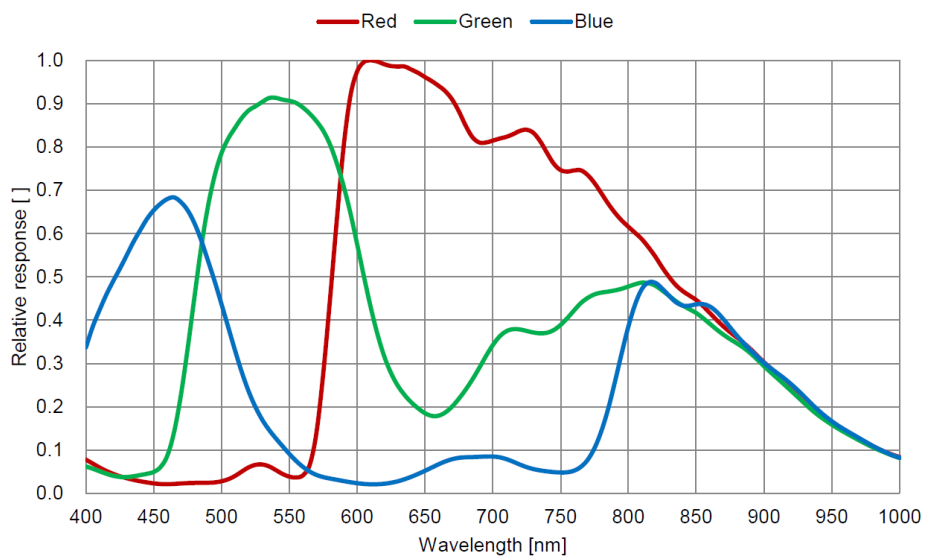

Figure 4-12 MER-041-302GC sensor spectral response

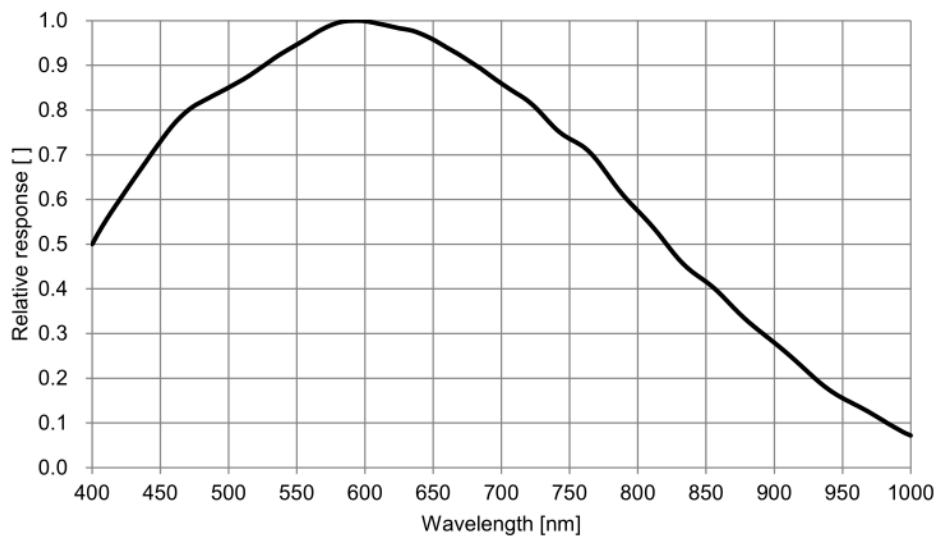

Figure 4-13 MER-041-302GM sensor spectral response

4.10. MER-041-302GC-P / MER-041-302GM-P

4.10.1. Parameters

Specifications	MER-041-302GC-P	MER-041-302GM-P
Resolution	720x540	
Sensor Type	Sony IMX287 global shutter CMOS	
Max. Image Circle	1/2.9 inch	
Pixel Size	6.90μm×6.90μm	
Frame Rate	Default: 99.16fps@720x540 Higher frame rates (302fps) are possible if you change the Packet Size to 8192 and the Bandwidth Reserve to 5	
ADC Bit Depth	12bit	
Pixel Bit Depth	8bit, 12bit	
Shutter Time	20μs~1s	
Gain	0dB~24dB	
Pixel Formats	Bayer RG8/Bayer RG12	Mono8/Mono12
Signal Noise Ratio	43.11dB	43.46dB
Synchronization	Hardware trigger, software trigger	
I/O	1 opto-isolated input line and 1 opto-isolated output line, 2 GPIOs	
Operating Temp.	0°C~45°C	
Storage Temp.	-20°C~70°C	
Operating Humidity	10%~80%	
Camera Power Requirements	PoE (Power over Ethernet, 802.3af compliant) or +12 VDC (± 10%), supplied via the camera's 8-pin Hirose connector	
Power Consumption	<3W@12VDC, <3.75W@PoE	
Lens Mount	C	

Dimensions	38.3mm×29mm×29mm (without lens adapter or connectors)
Weight	75g
Operating System	Windows XP / Win7 / Win8 / Win8.1 / Win10 / Windows Embedded 32bit and 64bit OS, Ubuntu14.04 / Ubuntu16.04 Linux OS
Data Interface	Fast Ethernet (100Mbit/s) or Gigabit Ethernet (1000Mbit/s)
Programmable Control	Image size, gain, Exposure time, trigger polarity, flash polarity
Conformity	CE, RoHS, FCC, GigE Vision, GenICam, IEEE802.3af

4.10.2. Spectral Response

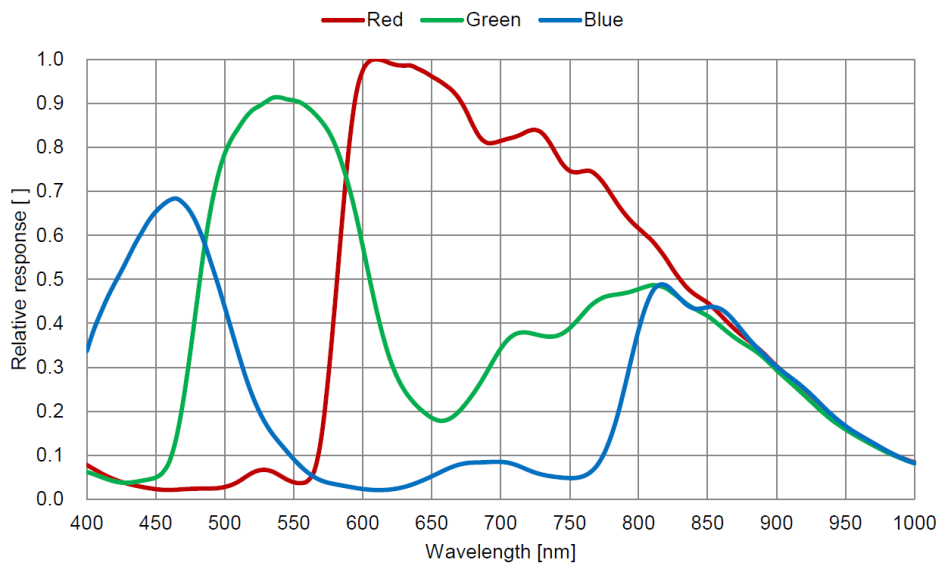

Figure 4-14 MER-041-302GC-P sensor spectral response

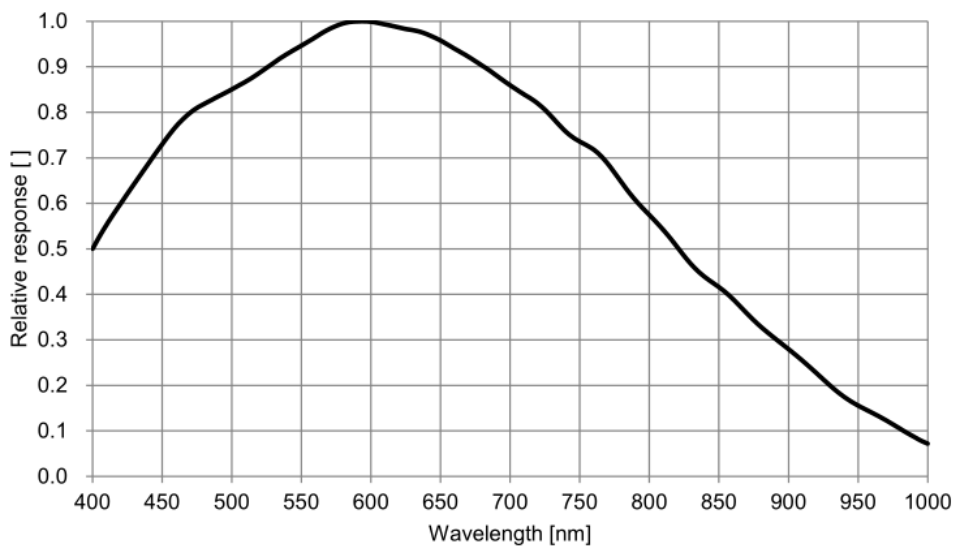

Figure 4-15 MER-041-302GM-P sensor spectral response

4.11. MER-050-200GC / MER-050-200GM

4.11.1. Parameters

Specifications	MER-050-200GC	MER-050-200GM
Resolution	800×600	
Sensor Type	ON PYTHON 500 global shutter CMOS	
Max. Image Circle	1/3.6 inch	
Pixel Size	4.8μm×4.8μm	
Frame Rate	200fps@800×600	
ADC Bit Depth	10bit	
Pixel Bit Depth	8bit, 10bit	
Shutter Time	20μs~1s	
Gain	0dB~16dB	
Pixel Formats	Bayer RG8/Bayer RG10	Mono8/Mono10
Signal Noise Ratio	38.16dB	38.77dB
Synchronization	Hardware trigger, software trigger	
I/O	1 opto-isolated input line and 1 opto-isolated output line, 2 GPIOs	
Operating Temp.	0°C~45°C	
Storage Temp.	-20°C~70°C	
Operating Humidity	10%~80%	
Power Consumption	<3W@12V	
Lens Mount	C	
Dimensions	29mm×29mm×29mm (without lens adapter or connectors)	
Weight	60g	
Operating System	Windows XP / Win7 / Win8 / Win8.1 / Win10 / Windows Embedded 32bit and 64bit OS, Ubuntu14.04 / Ubuntu16.04 Linux OS	
Data Interface	Fast Ethernet (100Mbit/s) or Gigabit Ethernet (1000Mbit/s)	

Programmable Control	Image size, gain, Exposure time, trigger polarity, flash polarity
Conformity	CE, RoHS, FCC, GigE Vision, GenICam

4.11.2. Spectral Response

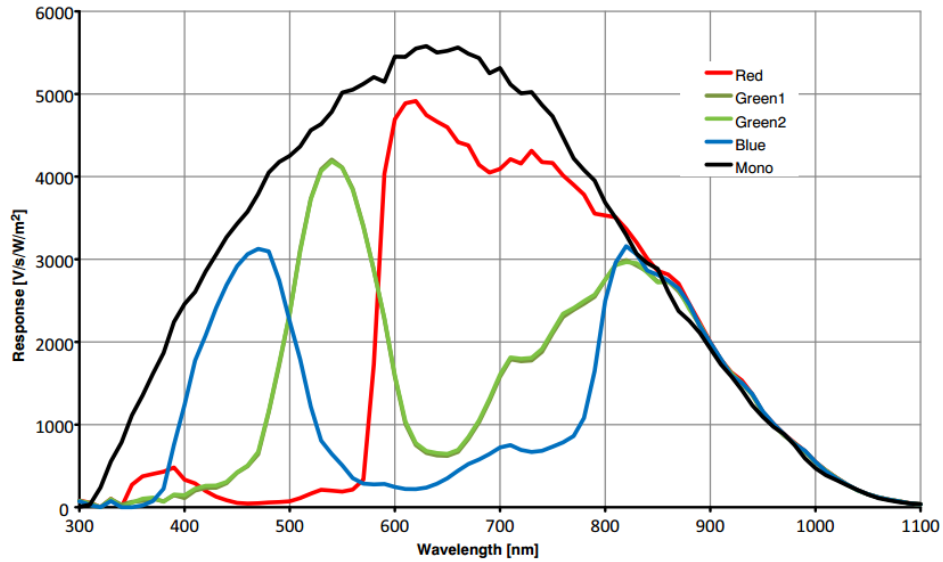

Figure 4-16 MER-050-200GC / MER-050-200GM sensor spectral response

4.12. MER-050-200GC-P / MER-050-200GM-P

4.12.1. Parameters

Specifications	MER-050-200GC-P	MER-050-200GM-P
Resolution	800×600	
Sensor Type	ON PYTHON 500 global shutter CMOS	
Max. Image Circle	1/3.6 inch	
Pixel Size	4.8μm×4.8μm	
Frame Rate	200fps@800×600	
ADC Bit Depth	10bit	
Pixel Bit Depth	8bit, 10bit	
Shutter Time	20μs~1s	
Gain	0dB~16dB	
Pixel Formats	Bayer RG8/Bayer RG10	Mono8/Mono10

Signal Noise Ratio	38.54dB	38.32dB
Synchronization	Hardware trigger, software trigger	
I/O	1 opto-isolated input line and 1 opto-isolated output line, 2 GPIOs	
Operating Temp.	0°C~45°C	
Storage Temp.	-20°C~70°C	
Operating Humidity	10%~80%	
Camera Power Requirements	PoE (Power over Ethernet, 802.3af compliant) or +12 VDC (± 10%), supplied via the camera's 8-pin Hirose connector	
Power Consumption	<3W@12VDC, <3.75W@PoE	
Lens Mount	C	
Dimensions	38.3mm×29mm×29mm (without lens adapter or connectors)	
Weight	75g	
Operating System	Windows XP / Win7 / Win8 / Win8.1 / Win10 / Windows Embedded 32bit and 64bit OS, Ubuntu14.04 / Ubuntu16.04 Linux OS	
Data Interface	Fast Ethernet (100Mbit/s) or Gigabit Ethernet (1000Mbit/s)	
Programmable Control	Image size, gain, Exposure time, trigger polarity, flash polarity	
Conformity	CE, RoHS, FCC, GigE Vision, GenICam, IEEE802.3af	

4.12.2. Spectral Response

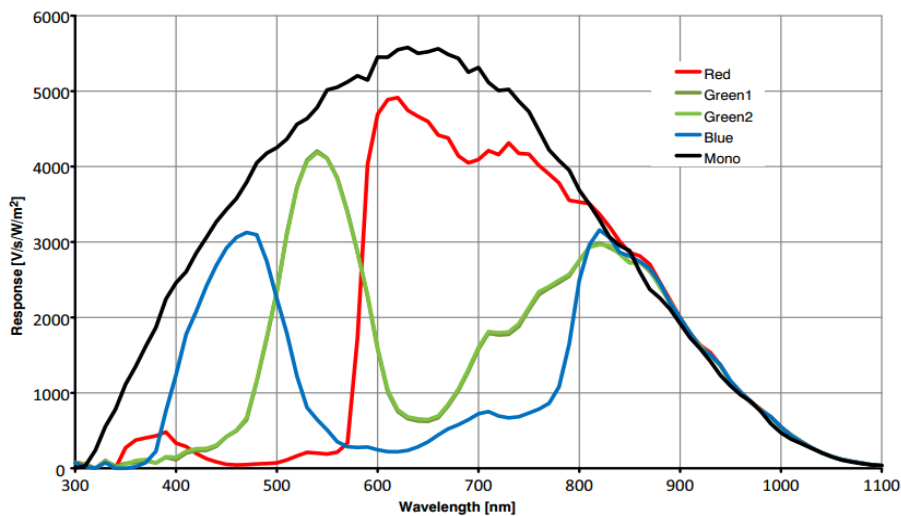

Figure 4-17 MER-050-200GC-P / MER-050-200GM-P sensor spectral response

4.13. MER-050-200GM-P NIR

4.13.1. Parameters

Specifications	MER-050-200GM-P NIR
Resolution	800×600
Sensor Type	ON PYTHON 500 global shutter CMOS
Max. Image Circle	1/3.6 inch
Pixel Size	4.8μm×4.8μm
Frame Rate	200fps@800×600
ADC Bit Depth	10bit
Pixel Bit Depth	8bit, 10bit
Shutter Time	20μs~1s
Gain	0dB ~16dB
Pixel Formats	Mono8/Mono10
Signal Noise Ratio	38.44dB
Synchronization	Hardware trigger, software trigger
I/O	1 opto-isolated input line and 1 opto-isolated output line, 2 GPIOs
Operating Temp.	0°C~45°C
Storage Temp.	-20°C~70°C
Operating Humidity	10%~80%
Camera Power Requirements	PoE (Power over Ethernet, 802.3af compliant) or +12 VDC (± 10%), supplied via the camera's 8-pin Hirose connector
Power Consumption	<3W@12VDC, <3.75W@PoE
Lens Mount	C
Dimensions	38.3mm×29mm×29mm (without lens adapter or connectors)
Weight	75g
Operating System	Windows XP / Win7 / Win8 / Win8.1 / Win10 / Windows Embedded 32bit and 64bit OS, Ubuntu14.04 / Ubuntu16.04 Linux OS

Data Interface	Fast Ethernet (100Mbit/s) or Gigabit Ethernet (1000Mbit/s)
Programmable Control	Image size, gain, Exposure time, trigger polarity, flash polarity
Conformity	CE, RoHS, FCC, GigE Vision, GenICam, IEEE802.3af

4.13.2. Spectral Response

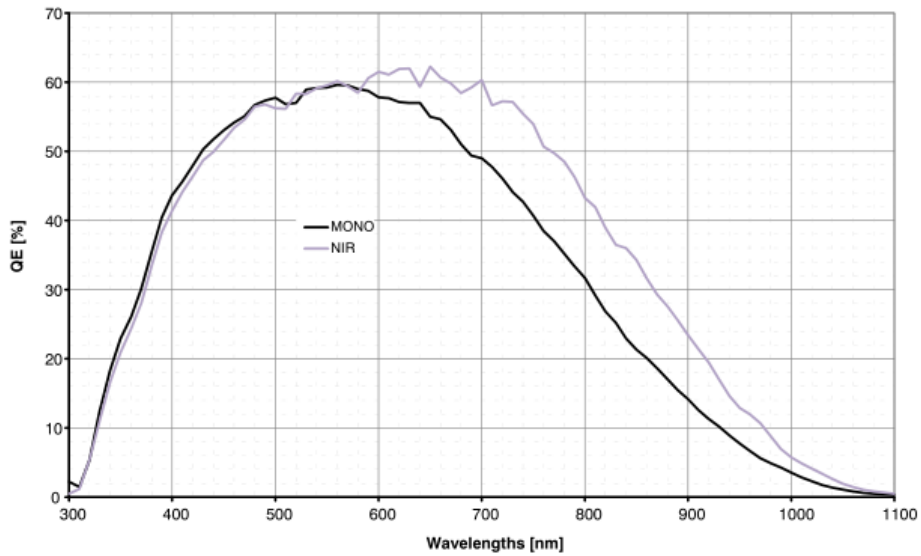

Figure 4-18 MER-050-200GM-P NIR sensor spectral response

4.14. MER-051-120GC / MER-051-120GM

4.14.1. Parameters

Specifications	MER-051-120GC	MER-051-120GM
Resolution	808x608	
Sensor Type	ON PYTHON 480 global shutter CMOS	
Max. Image Circle	1/3.6 inch	
Pixel Size	4.8μm×4.8μm	
Frame Rate	120fps@808x608	
ADC Bit Depth	10bit	
Pixel Bit Depth	8bit, 10bit	
Shutter Time	1μs~1s	
Gain	0dB~16dB	

Pixel Formats	Bayer RG8/Bayer RG10	Mono8/Mono10
Signal Noise Ratio	37.82dB	38.62dB
Synchronization	Hardware trigger, software trigger	
I/O	1 opto-isolated input line and 1 opto-isolated output line, 2 GPIOs	
Operating Temp.	0°C~45°C	
Storage Temp.	-20°C~70°C	
Operating Humidity	10%~80%	
Power Consumption	<3W@12V	
Lens Mount	C	
Dimensions	29mmx29mmx29mm (without lens adapter or connectors)	
Weight	60g	
Operating System	Windows XP / Win7 / Win8 / Win8.1 / Win10 / Windows Embedded 32bit and 64bit OS, Ubuntu14.04 / Ubuntu16.04 Linux OS	
Data Interface	Fast Ethernet (100Mbit/s) or Gigabit Ethernet (1000Mbit/s)	
Programmable Control	Image size, gain, Exposure time, trigger polarity, flash polarity	
Conformity	CE, RoHS, FCC, GigE Vision, GenICam	

4.14.2. Spectral Response

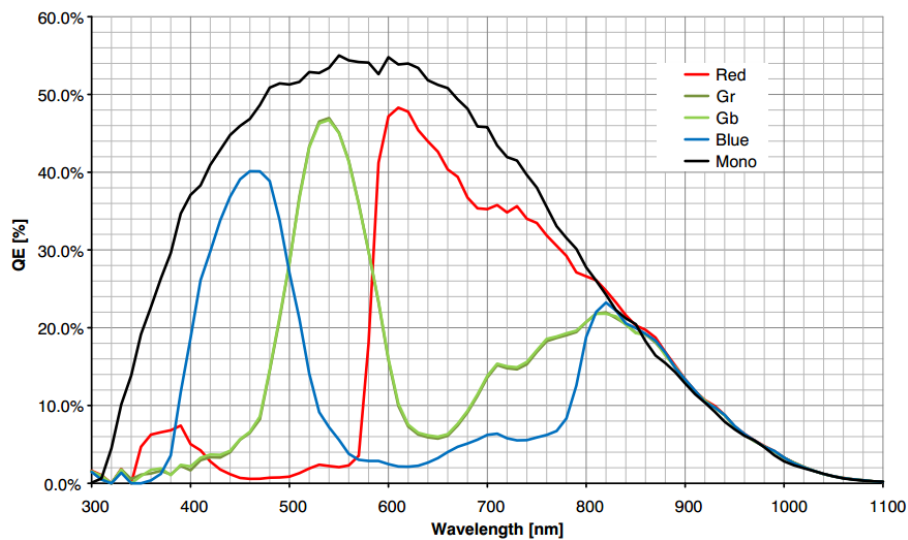

Figure 4-19 MER-051-120GC / MER-051-120GM sensor spectral response

4.15. MER-051-120GC-P / MER-051-120GM-P

4.15.1. Parameters

Specifications	MER-051-120GC-P	MER-051-120GM-P
Resolution	808×608	
Sensor Type	ON PYTHON 480 global shutter CMOS	
Max. Image Circle	1/3.6 inch	
Pixel Size	4.8μm×4.8μm	
Frame Rate	120fps@808×608	
ADC Bit Depth	10bit	
Pixel Bit Depth	8bit, 10bit	
Shutter Time	1μs~1s	
Gain	0dB~16dB	
Pixel Formats	Bayer RG8/Bayer RG10	Mono8/Mono10
Signal Noise Ratio	37.57dB	38.82dB
Synchronization	Hardware trigger, software trigger	
I/O	1 opto-isolated input line and 1 opto-isolated output line, 2 GPIOs	
Operating Temp.	0°C~45°C	
Storage Temp.	-20°C~70°C	
Operating Humidity	10%~80%	
Camera Power Requirements	PoE (Power over Ethernet, 802.3af compliant) or +12 VDC (± 10%), supplied via the camera's 8-pin Hirose connector	
Power Consumption	<3W@12VDC, <3.75W@PoE	
Lens Mount	C	
Dimensions	38.3mm×29mm×29mm (without lens adapter or connectors)	
Weight	75g	
Operating System	Windows XP / Win7 / Win8 / Win8.1 / Win10 / Windows Embedded 32bit and 64bit OS, Ubuntu14.04 / Ubuntu16.04 Linux OS	

Data Interface	Fast Ethernet (100Mbit/s) or Gigabit Ethernet (1000Mbit/s)
Programmable Control	Image size, gain, Exposure time, trigger polarity, flash polarity
Conformity	CE, RoHS, FCC, GigE Vision, GenICam, IEEE802.3af

4.15.2. Spectral Response

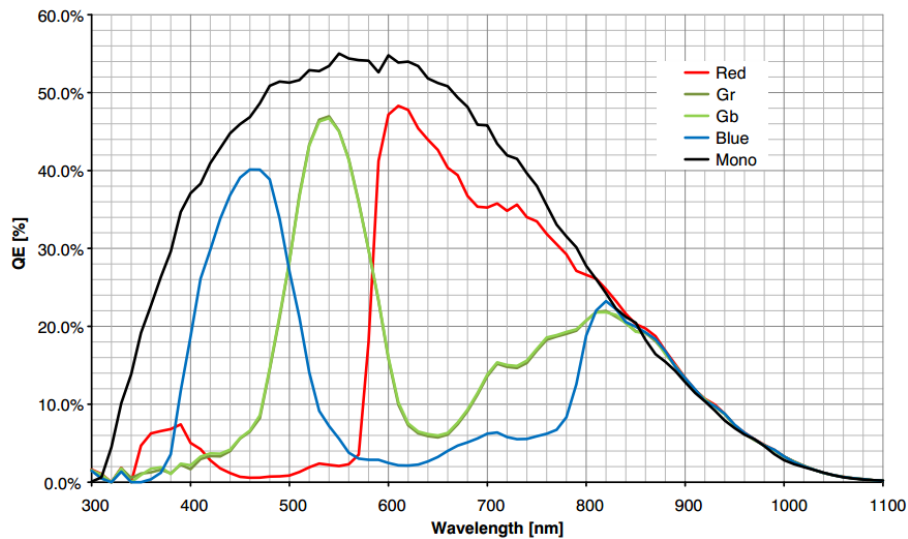

Figure 4-20 MER-051-120GC-P / MER-051-120GM-P sensor spectral response

4.16. MER-125-30GC / MER-125-30GM

4.16.1. Parameters

Specifications	MER-125-30GC	MER-125-30GM
Resolution	1292x964	
Sensor Type	Sony ICX445 AL/AQ global shutter CCD	
Max. Image Circle	1/3 inch	
Pixel Size	3.75μm×3.75μm	
Frame Rate	30fps@1292x964	
ADC Bit Depth	12bit	
Pixel Bit Depth	8bit, 12bit	
Shutter Time	20μs~1s	
Gain	0dB~25dB	

Pixel Formats	Bayer RG8/Bayer RG12	Mono8/Mono12
Signal Noise Ratio	37.49dB	36dB
Synchronization	Hardware trigger, software trigger	
I/O	1 opto-isolated input line and 1 opto-isolated output line, 2 GPIOs	
Operating Temp.	0°C~45°C	
Storage Temp.	-20°C~70°C	
Operating Humidity	10%~80%	
Power Consumption	<3W@12V	
Lens Mount	C	
Dimensions	29mmx29mmx29mm (without lens adapter or connectors)	
Weight	60g	
Operating System	Windows XP / Win7 / Win8 / Win8.1 / Win10 / Windows Embedded 32bit and 64bit OS, Ubuntu14.04 / Ubuntu16.04 Linux OS	
Data Interface	Fast Ethernet (100Mbit/s) or Gigabit Ethernet (1000Mbit/s)	
Programmable Control	Image size, gain, Exposure time, trigger polarity, flash polarity	
Conformity	CE, RoHS, FCC, GigE Vision, GenICam	

4.16.2. Spectral Response

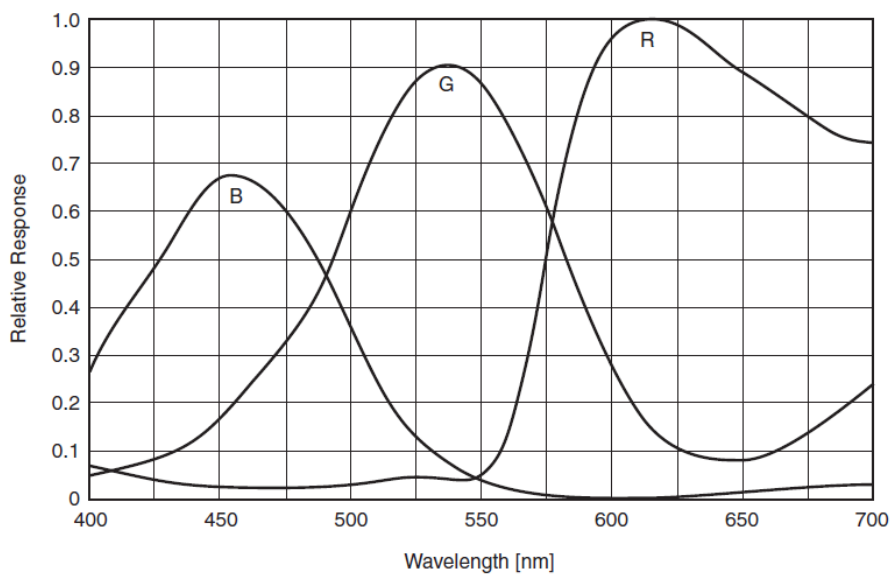

Figure 4-21 MER-125-30GC sensor spectral response

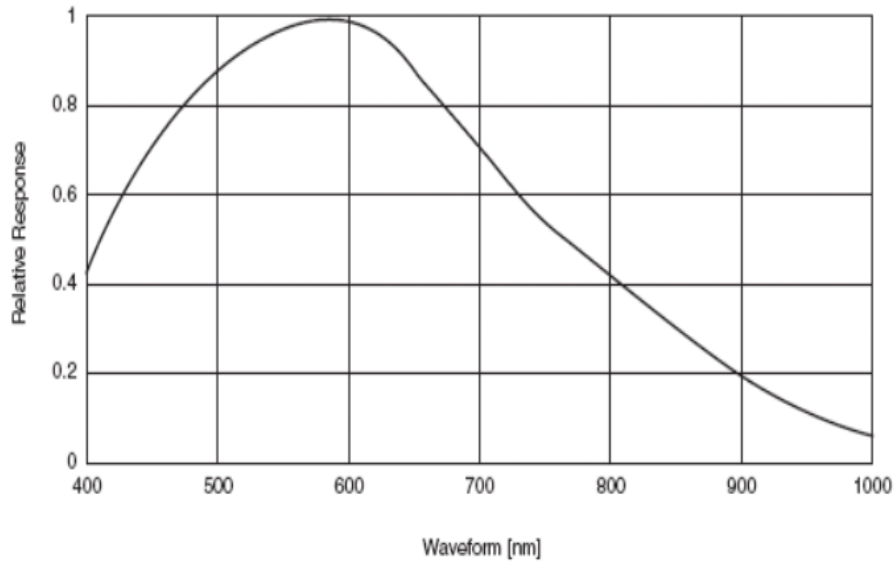

Figure 4-22 MER-125-30GM sensor spectral response

4.17. MER-125-30GC-P / MER-125-30GM-P

4.17.1. Parameters

Specifications	MER-125-30GC-P	MER-125-30GM-P
Resolution	1292x964	
Sensor Type	Sony ICX445 AL/AQ global shutter CCD	
Max. Image Circle	1/3 inch	
Pixel Size	3.75μm×3.75μm	
Frame Rate	30fps@1292x964	
ADC Bit Depth	12bit	
Pixel Bit Depth	8bit, 12bit	
Shutter Time	20μs~1s	
Gain	0dB~25dB	
Pixel Formats	Bayer RG8/Bayer RG12	Mono8/Mono12
Signal Noise Ratio	38.26dB	37.92dB
Synchronization	Hardware trigger, software trigger	
I/O	1 opto-isolated input line and 1 opto-isolated output line, 2 GPIOs	

Operating Temp.	0°C~45°C
Storage Temp.	-20°C~70°C
Operating Humidity	10%~80%
Camera Power Requirements	PoE (Power over Ethernet, 802.3af compliant) or +12 VDC (± 10%), supplied via the camera's 8-pin Hirose connector
Power Consumption	<3W@12VDC, <3.75W@PoE
Lens Mount	C
Dimensions	38.3mm×29mm×29mm (without lens adapter or connectors)
Weight	75g
Operating System	Windows XP / Win7 / Win8 / Win8.1 / Win10 / Windows Embedded 32bit and 64bit OS, Ubuntu14.04 / Ubuntu16.04 Linux OS
Data Interface	Fast Ethernet (100Mbit/s) or Gigabit Ethernet (1000Mbit/s)
Programmable Control	Image size, gain, Exposure time, trigger polarity, flash polarity
Conformity	CE, RoHS, FCC, GigE Vision, GenICam, IEEE802.3af

4.17.2. Spectral Response

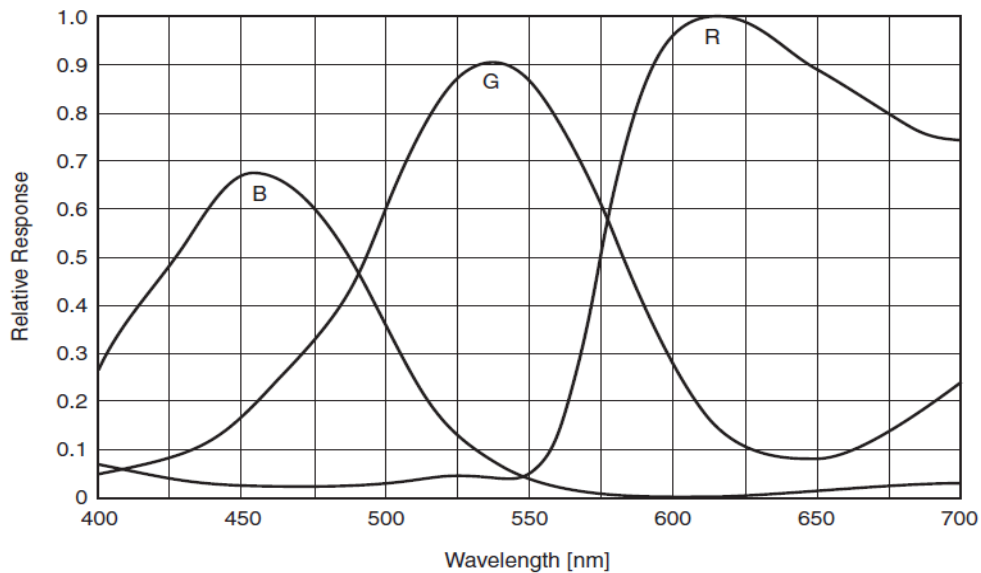

Figure 4-23 MER-125-30GC-P sensor spectral response

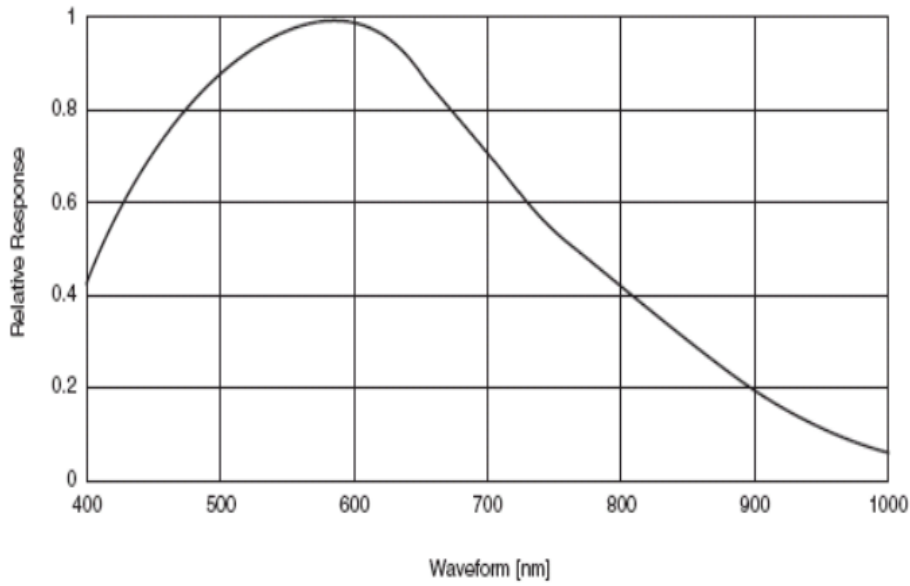

Figure 4-24 MER-125-30GM-P sensor spectral response

4.18. MER-130-30GM

4.18.1. Parameters

Specifications	MER-130-30GM
Resolution	1280×1024
Sensor Type	Aptina MT9M001 electronic rolling shutter CMOS
Max. Image Circle	1/2 inch
Pixel Size	5.2μm×5.2μm
Frame Rate	30fps@1280×1024
ADC Bit Depth	10bit
Pixel Bit Depth	8bit, 10bit
Shutter Time	28μs~500ms
Gain	0dB~16dB
Pixel Formats	Mono8/Mono10
Signal Noise Ratio	45.81dB

Synchronization	Hardware trigger, software trigger
I/O	1 opto-isolated input line and 1 opto-isolated output line, 2 GPIOs
Operating Temp.	0°C~45°C
Storage Temp.	-20°C~70°C
Operating Humidity	10%~80%
Power Consumption	<3W@12V
Lens Mount	C
Dimensions	29mm×29mm×29mm (without lens adapter or connectors)
Weight	60g
Operating System	Windows XP / Win7 / Win8 / Win8.1 / Win10 / Windows Embedded 32bit and 64bit OS, Ubuntu14.04 / Ubuntu16.04 Linux OS
Data Interface	Fast Ethernet (100Mbit/s) or Gigabit Ethernet (1000Mbit/s)
Programmable Control	Image size, gain, Exposure time, trigger polarity, flash polarity
Conformity	CE, RoHS, FCC, GigE Vision, GenICam

4.18.2. Spectral Response

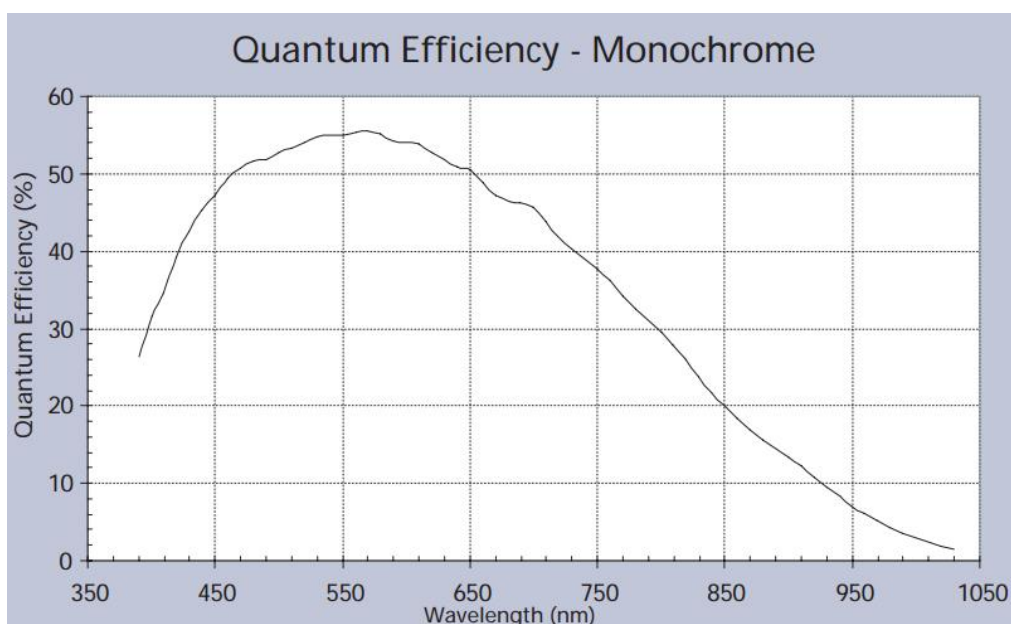

Figure 4-25 MER-130-30GM sensor spectral response

4.19. MER-131-75GC / MER-131-75GM

4.19.1. Parameters

Specifications	MER-131-75GC	MER-131-75GM
Resolution	1280×1024	
Sensor Type	ON PYTHON 1300 global shutter CMOS	
Max. Image Circle	1/2 inch	
Pixel Size	4.8μm×4.8μm	
Frame Rate	75fps@1280×1024	
ADC Bit Depth	10bit	
Pixel Bit Depth	8bit, 10bit	
Shutter Time	1μs~1s	
Gain	0dB~16dB	
Pixel Formats	Bayer RG8/Bayer RG10	Mono8/Mono10
Signal Noise Ratio	44dB	38.03dB
Synchronization	Hardware trigger, software trigger	
I/O	1 opto-isolated input line and 1 opto-isolated output line, 2 GPIOs	
Operating Temp.	0°C~45°C	
Storage Temp.	-20°C~70°C	
Operating Humidity	10%~80%	
Power Consumption	<3W@12V	
Lens Mount	C	
Dimensions	29mm×29mm×29mm (without lens adapter or connectors)	
Weight	60g	
Operating System	Windows XP / Win7 / Win8 / Win8.1 / Win10 / Windows Embedded 32bit and 64bit OS, Ubuntu14.04 / Ubuntu16.04 Linux OS	
Data Interface	Fast Ethernet (100Mbit/s) or Gigabit Ethernet (1000Mbit/s)	
Programmable Control	Image size, gain, Exposure time, trigger polarity, flash polarity	

Conformity	CE, RoHS, FCC, GigE Vision, GenICam
------------	-------------------------------------

4.19.2. Spectral Response

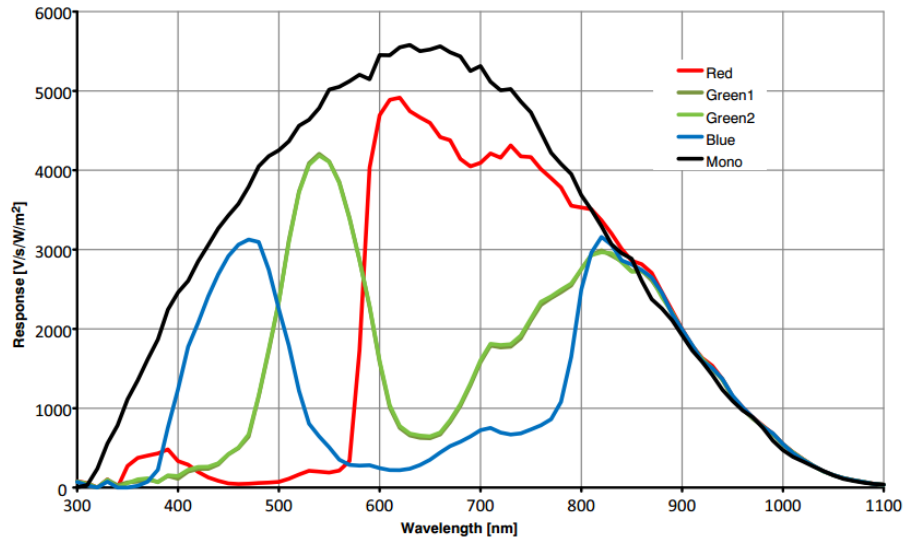

Figure 4-26 MER-131-75GC / MER-131-75GM sensor spectral response

4.20. MER-131-75GC-P / MER-131-75GM-P

4.20.1. Parameters

Specifications	MER-131-75GC-P	MER-131-75GM-P
Resolution	1280×1024	
Sensor Type	ON PYTHON 1300 global shutter CMOS	
Max. Image Circle	1/2 inch	
Pixel Size	4.8μm×4.8μm	
Frame Rate	75fps@1280×1024	
ADC Bit Depth	10bit	
Pixel Bit Depth	8bit, 10bit	
Shutter Time	1μs~1s	
Gain	0dB~16dB	
Pixel Formats	Bayer RG8/Bayer RG10	Mono8/Mono10
Signal Noise Ratio	37.95dB	38.29dB

Synchronization	Hardware trigger, software trigger
I/O	1 opto-isolated input line and 1 opto-isolated output line, 2 GPIOs
Operating Temp.	0°C~45°C
Storage Temp.	-20°C~70°C
Operating Humidity	10%~80%
Camera Power Requirements	PoE (Power over Ethernet, 802.3af compliant) or +12 VDC ($\pm 10\%$), supplied via the camera's 8-pin Hirose connector
Power Consumption	<3W@12VDC, <3.75W@PoE
Lens Mount	C
Dimensions	38.3mm×29mm×29mm (without lens adapter or connectors)
Weight	75g
Operating System	Windows XP / Win7 / Win8 / Win8.1 / Win10 / Windows Embedded 32bit and 64bit OS, Ubuntu14.04 / Ubuntu16.04 Linux OS
Data Interface	Fast Ethernet (100Mbit/s) or Gigabit Ethernet (1000Mbit/s)
Programmable Control	Image size, gain, Exposure time, trigger polarity, flash polarity
Conformity	CE, RoHS, FCC, GigE Vision, GenICam, KCC

4.20.2. Spectral Response

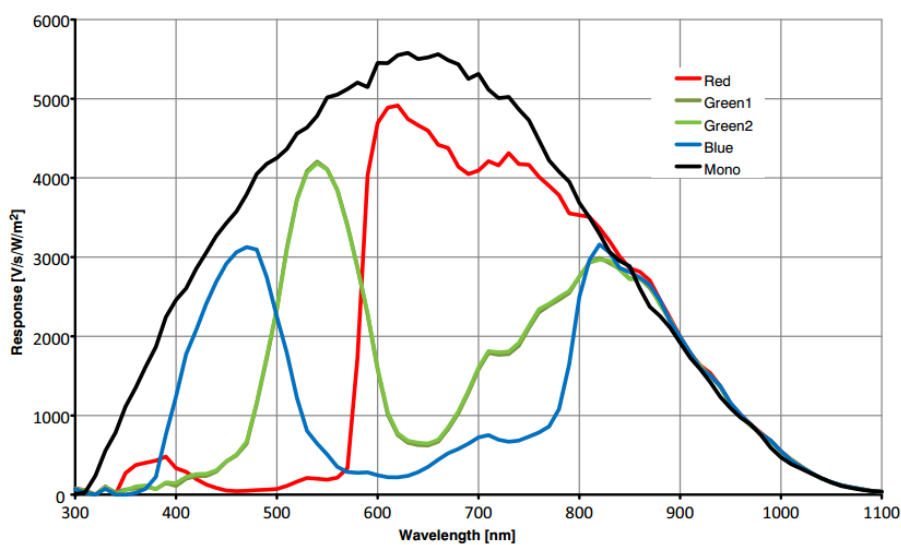

Figure 4-27 MER-131-75GC-P / MER-131-75GM-P sensor spectral response

4.21. MER-131-75GM-P NIR

4.21.1. Parameters

Specifications	MER-131-75GM-P NIR
Resolution	1280×1024
Sensor Type	ON PYTHON 1300 global shutter CMOS
Max. Image Circle	1/2 inch
Pixel Size	4.8μm×4.8μm
Frame Rate	75fps@1280×1024
ADC Bit Depth	10bit
Pixel Bit Depth	8bit, 10bit
Shutter Time	1μs~1s
Gain	0dB~16dB
Pixel Formats	Mono8/Mono10
Signal Noise Ratio	38.18dB
Synchronization	Hardware trigger, software trigger
I/O	1 opto-isolated input line and 1 opto-isolated output line, 2 GPIOs
Operating Temp.	0°C~45°C
Storage Temp.	-20°C~70°C
Operating Humidity	10% ~80%
Camera Power Requirements	PoE (Power over Ethernet, 802.3af compliant) or +12 VDC (± 10%), supplied via the camera's 8-pin Hirose connector
Power Consumption	<3W@12VDC, <3.75W@PoE
Lens Mount	C
Dimensions	38.3mm×29mm×29mm (without lens adapter or connectors)

Weight	75g
Operating System	Windows XP / Win7 / Win8 / Win8.1 / Win10 / Windows Embedded 32bit and 64bit OS, Ubuntu14.04 / Ubuntu16.04 Linux OS
Data Interface	Fast Ethernet (100Mbit/s) or Gigabit Ethernet (1000Mbit/s)
Programmable Control	Image size, gain, Exposure time, trigger polarity, flash polarity
Conformity	CE, RoHS, FCC, GigE Vision, GenICam, IEEE802.3af

4.21.2. Spectral Response

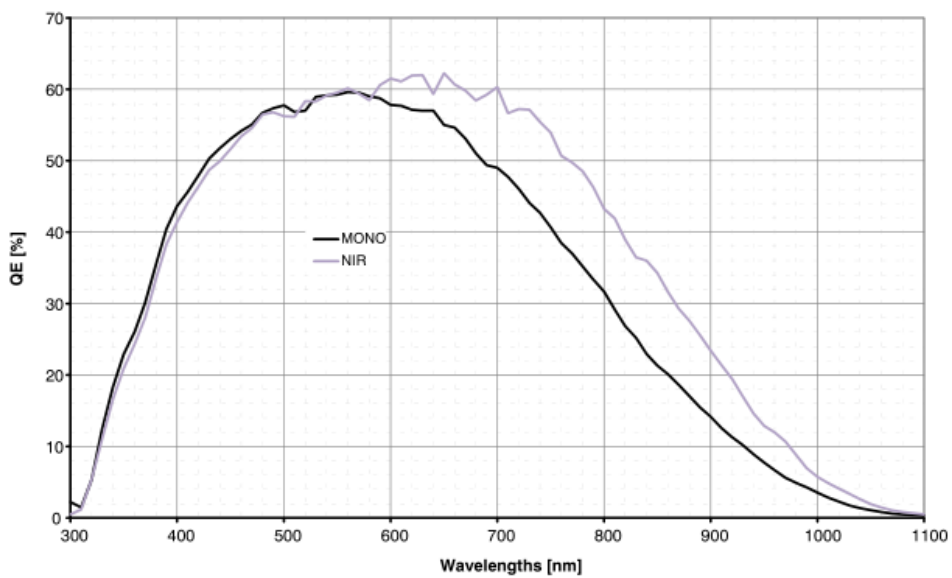

Figure 4-28 MER-131-75GM-P NIR sensor spectral response

4.22. MER-132-30GC / MER-132-30GM

4.22.1. Parameters

Specifications	MER-132-30GC	MER-132-30GM
Resolution	1292x964	
Sensor Type	Global shutter CCD	
Max. Image Circle	1/3 inch	
Pixel Size	3.75μm×3.75μm	
Frame Rate	30fps@1292x964	

ADC Bit Depth	12bit	
Pixel Bit Depth	8bit, 12bit	
Shutter Time	8 μ s~1s	
Gain	0dB~25dB	
Pixel Formats	Bayer RG8/Bayer RG12	Mono8/Mono12
Signal Noise Ratio	45dB	37dB
Synchronization	Hardware trigger, software trigger	
I/O	1 opto-isolated input line and 1 opto-isolated output line, 2 GPIOs	
Operating Temp.	0°C~45°C	
Storage Temp.	-20°C~70°C	
Operating Humidity	10%~80%	
Power Consumption	<3W@12V	
Lens Mount	C	
Dimensions	29mm×29mm×29mm (without lens adapter or connectors)	
Weight	60g	
Operating System	Windows XP / Win7 / Win8 / Win8.1 / Win10 / Windows Embedded 32bit and 64bit OS, Ubuntu14.04 / Ubuntu16.04 Linux OS	
Data Interface	Fast Ethernet (100Mbit/s) or Gigabit Ethernet (1000Mbit/s)	
Programmable Control	Image size, gain, Exposure time, trigger polarity, flash polarity	
Conformity	CE, RoHS, FCC, GigE Vision, GenICam	

4.22.2. Spectral Response

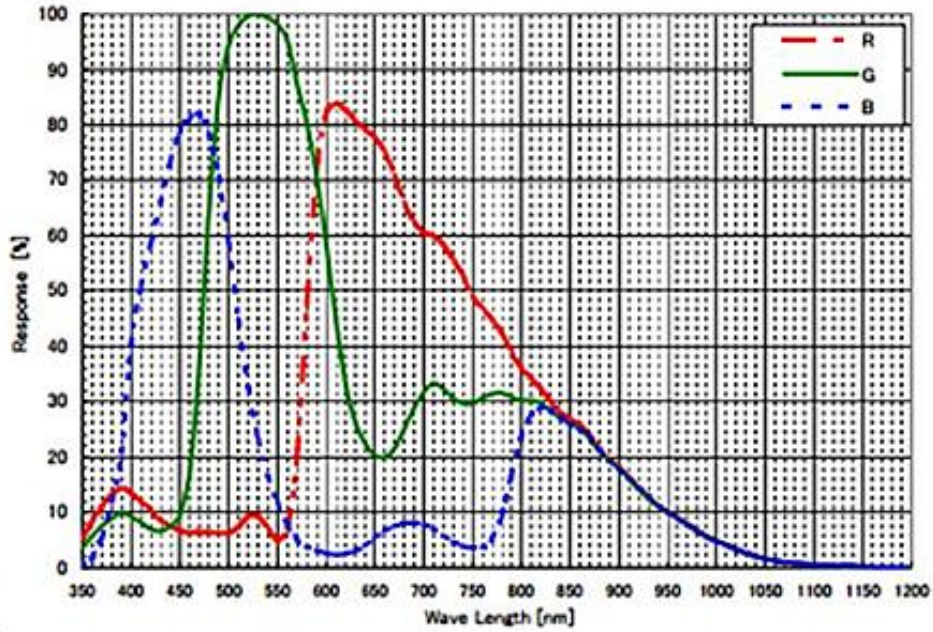

Figure 4-29 MER-132-30GC sensor spectral response

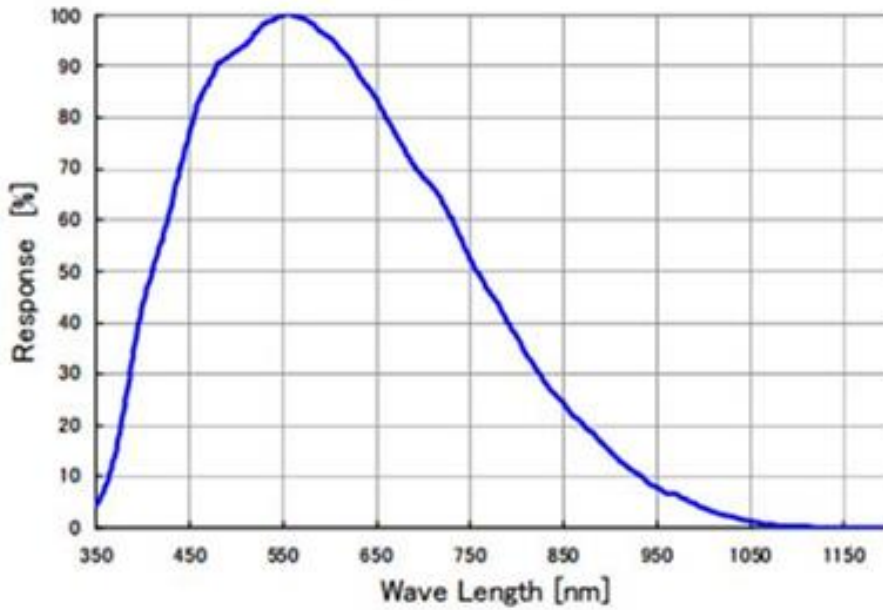

Figure 4-30 MER-132-30GM sensor spectral response

4.23. MER-132-43GC / MER-132-43GM

4.23.1. Parameters

Specifications	MER-132-43GC	MER-132-43GM
Resolution	1292x964	
Sensor Type	Global shutter CCD	
Max. Image Circle	1/3 inch	
Pixel Size	3.75 μ m \times 3.75 μ m	
Frame Rate	43fps@1292x964	
ADC Bit Depth	12bit	
Pixel Bit Depth	8bit, 12bit	
Shutter Time	6 μ s~1s	
Gain	0dB~25dB	
Pixel Formats	Bayer RG8/Bayer RG12	Mono8/Mono12
Signal Noise Ratio	39.12dB	39.76dB
Synchronization	Hardware trigger, software trigger	
I/O	1 opto-isolated input line and 1 opto-isolated output line, 2 GPIOs	
Operating Temp.	0 $^{\circ}$ C~45 $^{\circ}$ C	
Storage Temp.	-20 $^{\circ}$ C~70 $^{\circ}$ C	
Operating Humidity	10%~80%	
Power Consumption	<3W@12VDC	
Lens Mount	C	
Dimensions	29mm \times 29mm \times 29mm (without lens adapter or connectors)	
Weight	60g	

Operating System	Windows XP / Win7 / Win8 / Win8.1 / Win10 / Windows Embedded 32bit and 64bit OS, Ubuntu14.04 / Ubuntu16.04 Linux OS
Data Interface	Fast Ethernet (100Mbit/s) or Gigabit Ethernet (1000Mbit/s)
Programmable Control	Image size, gain, Exposure time, trigger polarity, flash polarity
Conformity	CE, RoHS, FCC, GigE Vision, GenICam

4.23.2. Spectral Response

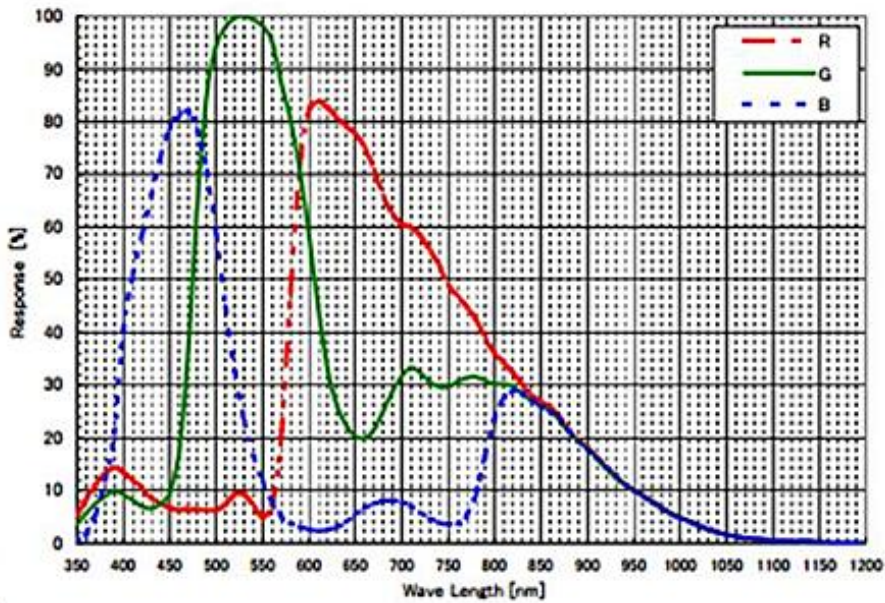

Figure 4-31 MER-132-43GC sensor spectral response

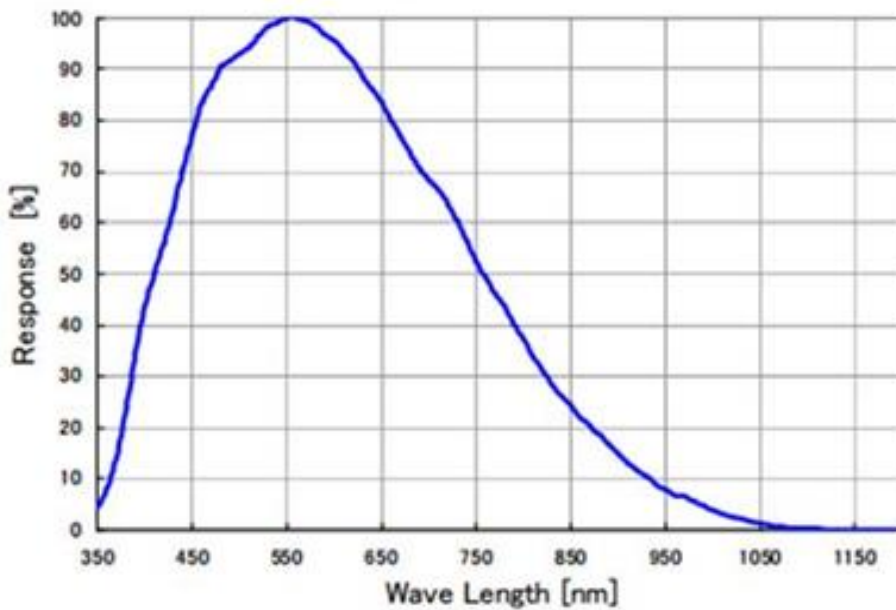

Figure 4-32 MER-132-43GM sensor spectral response

4.24. MER-132-43GC-P / MER-132-43GM-P

4.24.1. Parameters

Specifications	MER-132-43GC-P	MER-132-43GM-P
Resolution	1292x964	
Sensor Type	Global shutter CCD	
Max. Image Circle	1/3 inch	
Pixel Size	3.75μm×3.75μm	
Frame Rate	43fps@1292x964	
ADC Bit Depth	12bit	
Pixel Bit Depth	8bit, 12bit	
Shutter Time	6μs~1s	
Gain	0dB~25dB	
Pixel Formats	Bayer RG8/Bayer RG12	Mono8/Mono12
Signal Noise Ratio	39.33dB	39.74dB
Synchronization	Hardware trigger, software trigger	
I/O	1 opto-isolated input line and 1 opto-isolated output line, 2 GPIOs	
Operating Temp.	0°C~45°C	
Storage Temp.	-20°C~70°C	
Operating Humidity	10%~80%	
Camera Power Requirements	PoE (Power over Ethernet, 802.3af compliant) or +12 VDC (± 10%), supplied via the camera's 8-pin Hirose connector	
Power Consumption	<3W@12VDC, <3.75W@PoE	
Lens Mount	C	
Dimensions	38.3mm×29mm×29mm (without lens adapter or connectors)	

Weight	75g
Operating System	Windows XP / Win7 / Win8 / Win8.1 / Win10 / Windows Embedded 32bit and 64bit OS, Ubuntu14.04 / Ubuntu16.04 Linux OS
Data Interface	Fast Ethernet (100Mbit/s) or Gigabit Ethernet (1000Mbit/s)
Programmable Control	Image size, gain, Exposure time, trigger polarity, flash polarity
Conformity	CE, RoHS, FCC, GigE Vision, GenICam, IEEE802.3af, KCC

4.24.2. Spectral Response

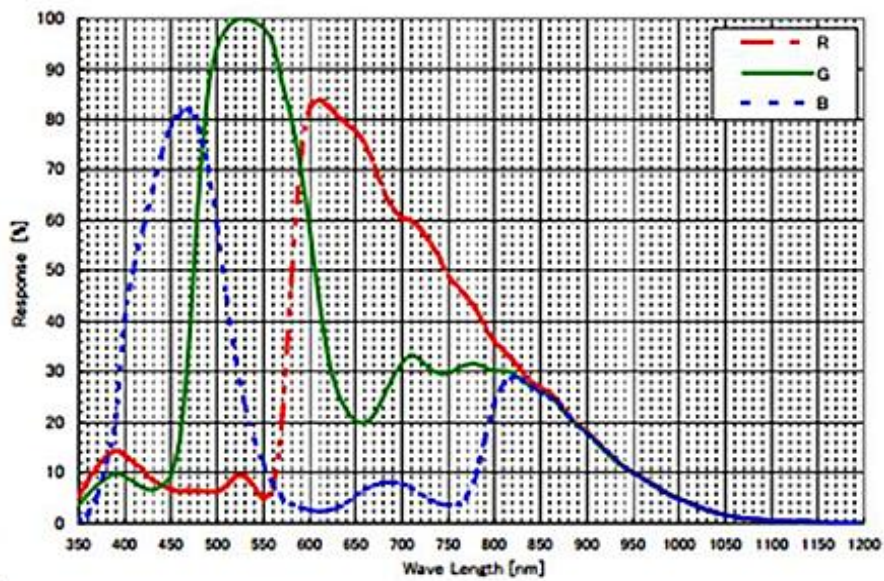

Figure 4-33 MER-132-43GC-P sensor spectral response

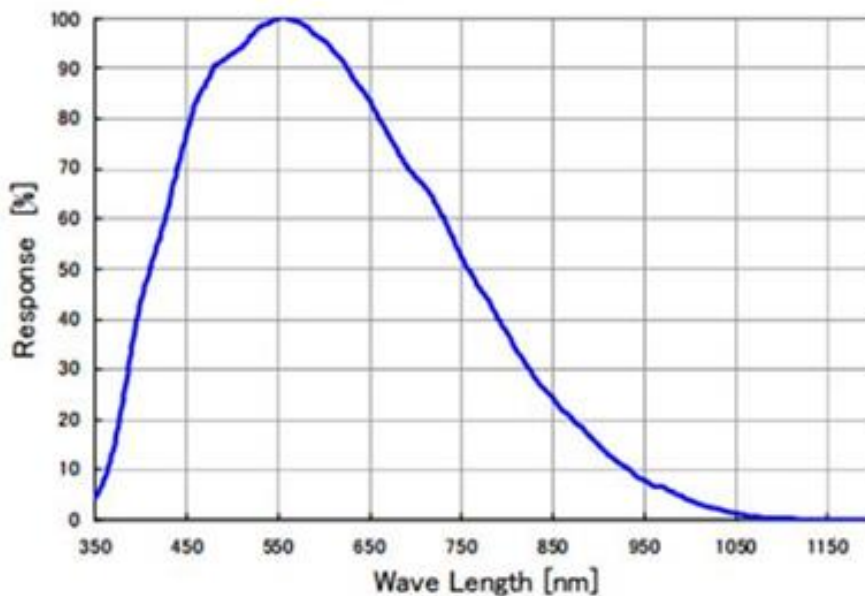

Figure 4-34 MER-132-43GM-P sensor spectral response

4.25. MER-133-54GC / MER-133-54GM

4.25.1. Parameters

Specifications	MER-133-54GC	MER-133-54GM
Resolution	1280×960	
Sensor Type	AR0135 global shutter CMOS	
Max. Image Circle	1/3 inch	
Pixel Size	3.75μm×3.75μm	
Frame Rate	54fps@1280×960	
ADC Bit Depth	10bit	
Pixel Bit Depth	8bit, 10bit	
Shutter Time	20μs~1s	
Gain	0dB~31dB	
Pixel Formats	Bayer GR8/Bayer GR10	Mono8/Mono10
Signal Noise Ratio	38.68dB	40dB
Synchronization	Hardware trigger, software trigger	
I/O	1 opto-isolated input line and 1 opto-isolated output line, 2 GPIOs	
Operating Temp.	0°C~45°C	
Storage Temp.	-20°C~70°C	
Operating Humidity	10%~80%	
Power Consumption	<3W@12V	
Lens Mount	C	
Dimensions	29mm×29mm×29mm (without lens adapter or connectors)	
Weight	60g	

Operating System	Windows XP / Win7 / Win8 / Win8.1 / Win10 / Windows Embedded 32bit and 64bit OS, Ubuntu14.04 / Ubuntu16.04 Linux OS
Data Interface	Fast Ethernet (100Mbit/s) or Gigabit Ethernet (1000Mbit/s)
Programmable Control	Image size, gain, Exposure time, trigger polarity, flash polarity
Conformity	CE, RoHS, FCC, GigE Vision, GenICam

4.25.2. Spectral Response

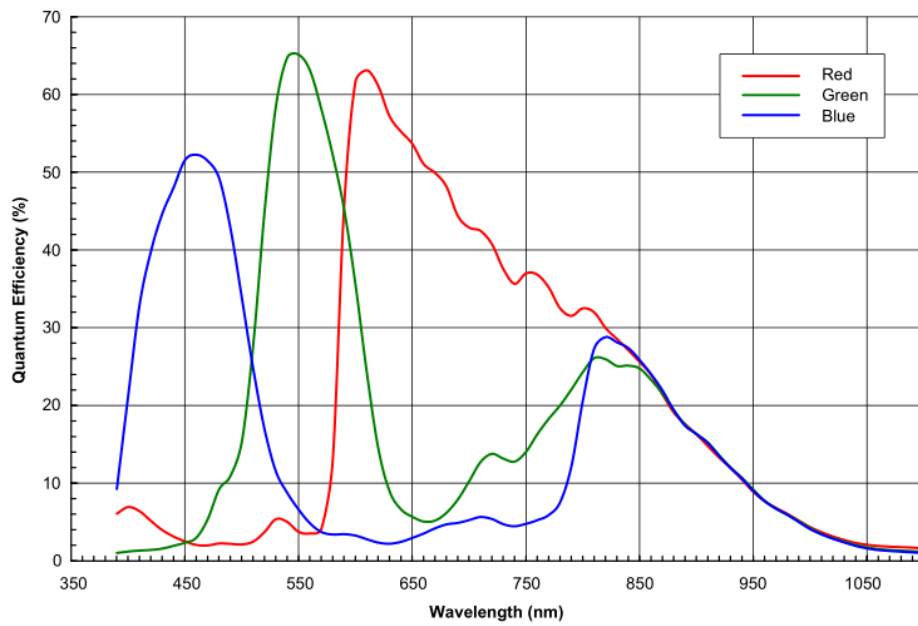

Figure 4-35 MER-133-54GC sensor spectral response

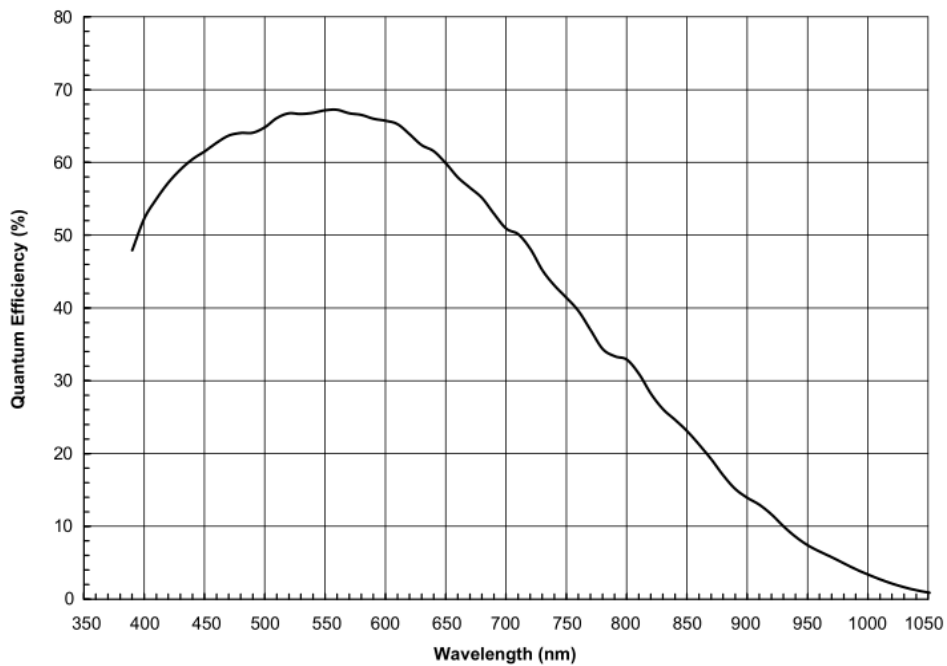

Figure 4-36 MER-133-54GM sensor spectral response

4.26. MER-133-54GC-P / MER-133-54GM-P

4.26.1. Parameters

Specifications	MER-133-54GC-P	MER-133-54GM-P
Resolution	1280×960	
Sensor Type	AR0135 global shutter CMOS	
Max. Image Circle	1/3 inch	
Pixel Size	3.75μm×3.75μm	
Frame Rate	54fps@1280×960	
ADC Bit Depth	10bit	
Pixel Bit Depth	8bit, 10bit	
Shutter Time	20μs~1s	
Gain	0dB~31dB	
Pixel Formats	Bayer GR8/Bayer GR10	Mono8/Mono10
Signal Noise Ratio	38.3dB	38.83dB
Synchronization	Hardware trigger, software trigger	
I/O	1 opto-isolated input line and 1 opto-isolated output line, 2 GPIOs	
Operating Temp.	0°C~45°C	
Storage Temp.	-20°C~70°C	
Operating Humidity	10%~80%	
Camera Power Requirements	PoE (Power over Ethernet, 802.3af compliant) or +12 VDC (± 10%), supplied via the camera's 8-pin Hirose connector	
Power Consumption	<3W@12VDC, <3.75W@PoE	
Lens Mount	C	
Dimensions	38.3mm×29mm×29mm (without lens adapter or connectors)	

Weight	75g
Operating System	Windows XP / Win7 / Win8 / Win8.1 / Win10 / Windows Embedded 32bit and 64bit OS, Ubuntu14.04 / Ubuntu16.04 Linux OS
Data Interface	Fast Ethernet (100Mbit/s) or Gigabit Ethernet (1000Mbit/s)
Programmable Control	Image size, gain, Exposure time, trigger polarity, flash polarity
Conformity	CE, RoHS, FCC, GigE Vision, GenICam, IEEE802.3af

4.26.2. Spectral Response

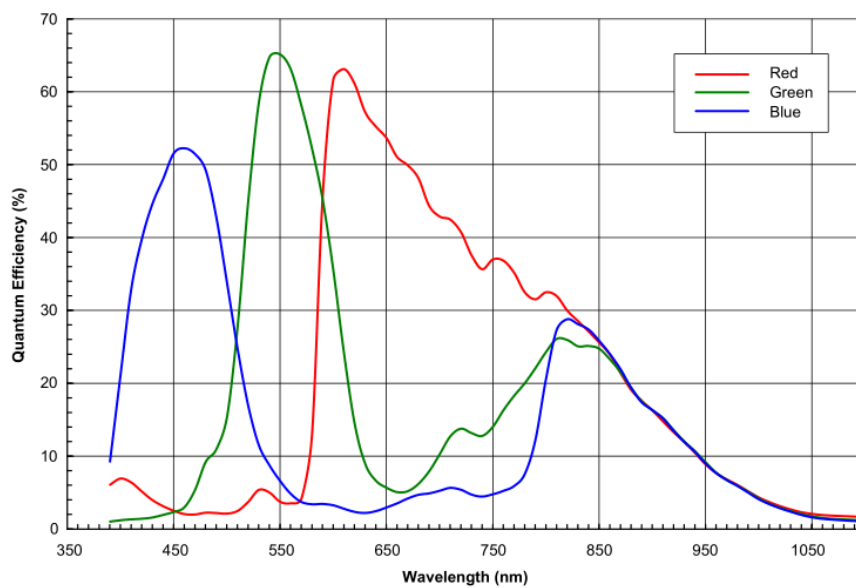

Figure 4-37 MER-133-54GC-P sensor spectral response

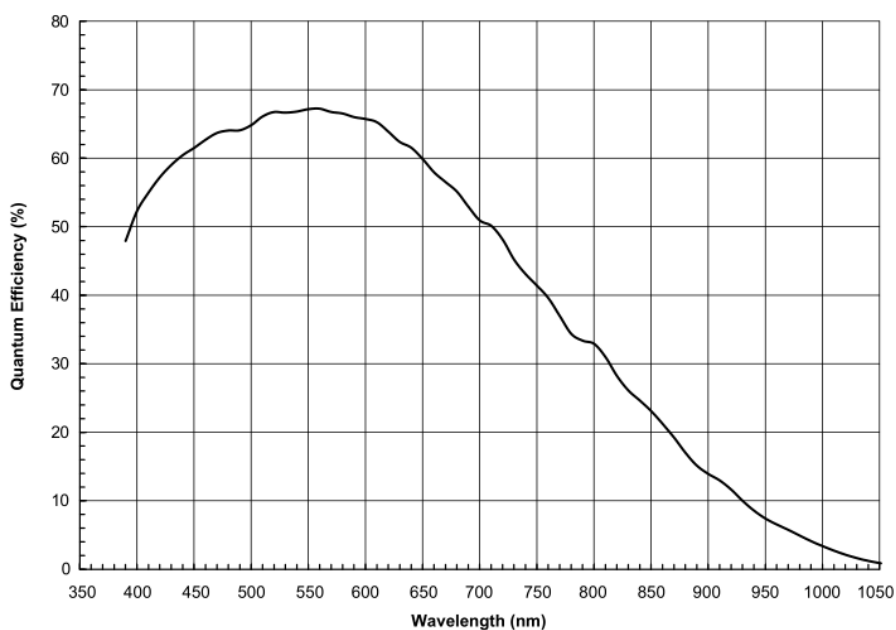

Figure 4-38 MER-133-54GM-P sensor spectral response

4.27. MER-200-14GC / MER-200-14GM

4.27.1. Parameters

Specifications	MER-200-14GC	MER-200-14GM
Resolution	1628x1236	
Sensor Type	Sony ICX274 AL/AQ global shutter CCD	
Max. Image Circle	1/1.8 inch	
Pixel Size	4.4μm×4.4μm	
Frame Rate	14fps@1628x1236	
ADC Bit Depth	12bit	
Pixel Bit Depth	8bit, 12bit	
Shutter Time	20μs~1s	
Gain	0dB~25dB	
Pixel Formats	Bayer RG8/Bayer RG12	Mono8/Mono12
Signal Noise Ratio	38.33dB	38.61dB
Synchronization	Hardware trigger, software trigger	
I/O	1 opto-isolated input line and 1 opto-isolated output line, 2 GPIOs	
Operating Temp.	0°C~45°C	
Storage Temp.	-20°C~70°C	
Operating Humidity	10%~80%	
Power Consumption	<3W@12VDC	
Lens Mount	C	
Dimensions	29mm×29mm×29mm (without lens adapter or connectors)	
Weight	60g	

Operating System	Windows XP / Win7 / Win8 / Win8.1 / Win10 / Windows Embedded 32bit and 64bit OS, Ubuntu14.04 / Ubuntu16.04 Linux OS
Data Interface	Fast Ethernet (100Mbit/s) or Gigabit Ethernet (1000Mbit/s)
Programmable Control	Image size, gain, Exposure time, trigger polarity, flash polarity
Conformity	CE, RoHS, FCC, GigE Vision, GenICam

4.27.2. Spectral Response

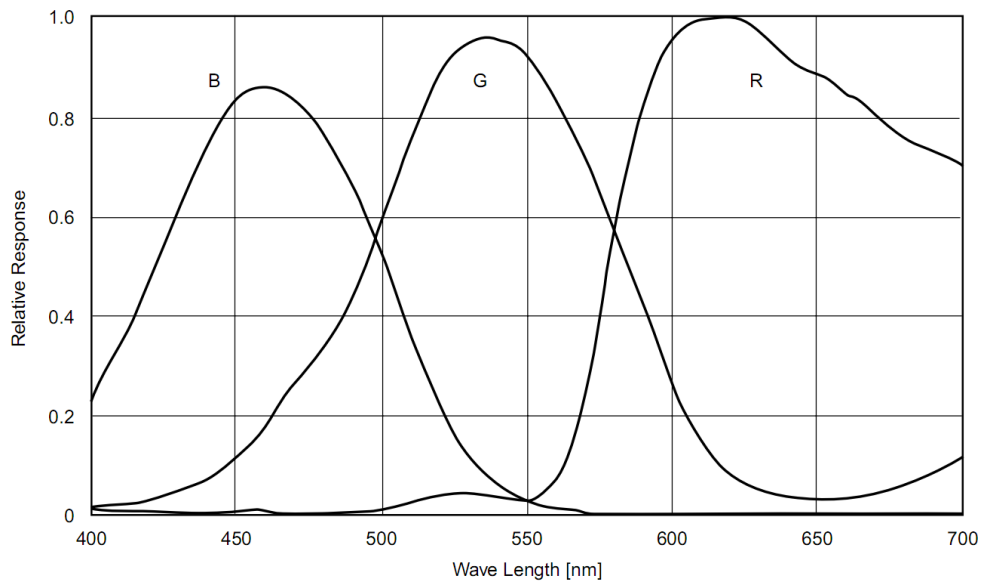

Figure 4-39 MER-200-14GC sensor spectral response

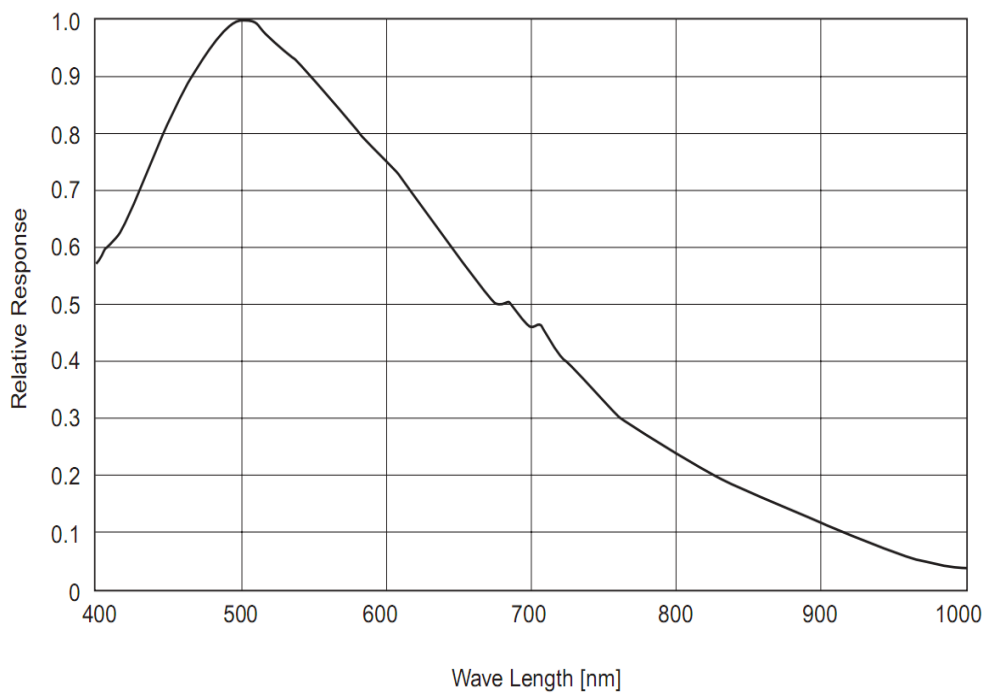

Figure 4-40 MER-200-14GM sensor spectral response

4.28. MER-200-20GC / MER-200-20GM

4.28.1. Parameters

Specifications	MER-200-20GC	MER-200-20GM
Resolution	1628×1236	
Sensor Type	Sony ICX274 AL/AQ global shutter CCD	
Max. Image Circle	1/1.8 inch	
Pixel Size	4.4μm×4.4μm	
Frame Rate	20fps@1628×1236	
ADC Bit Depth	12bit	
Pixel Bit Depth	8bit, 12bit	
Shutter Time	20μs~1s	
Gain	0dB~25dB	
Pixel Formats	Bayer RG8/Bayer RG12	Mono8/Mono12
Signal Noise Ratio	43dB	37dB
Synchronization	Hardware trigger, software trigger	
I/O	1 opto-isolated input line and 1 opto-isolated output line, 2 GPIOs	
Operating Temp.	0°C~45°C	
Storage Temp.	-20°C~70°C	
Operating Humidity	10%~80%	
Power Consumption	<3W@12VDC	
Lens Mount	C	
Dimensions	29mm×29mm×29mm (without lens adapter or connectors)	
Weight	60g	

Operating System	Windows XP / Win7 / Win8 / Win8.1 / Win10 / Windows Embedded 32bit and 64bit OS, Ubuntu14.04 / Ubuntu16.04 Linux OS
Data Interface	Fast Ethernet (100Mbit/s) or Gigabit Ethernet (1000Mbit/s)
Programmable Control	Image size, gain, Exposure time, trigger polarity, flash polarity
Conformity	CE, RoHS, FCC, GigE Vision, GenICam

4.28.2. Spectral Response

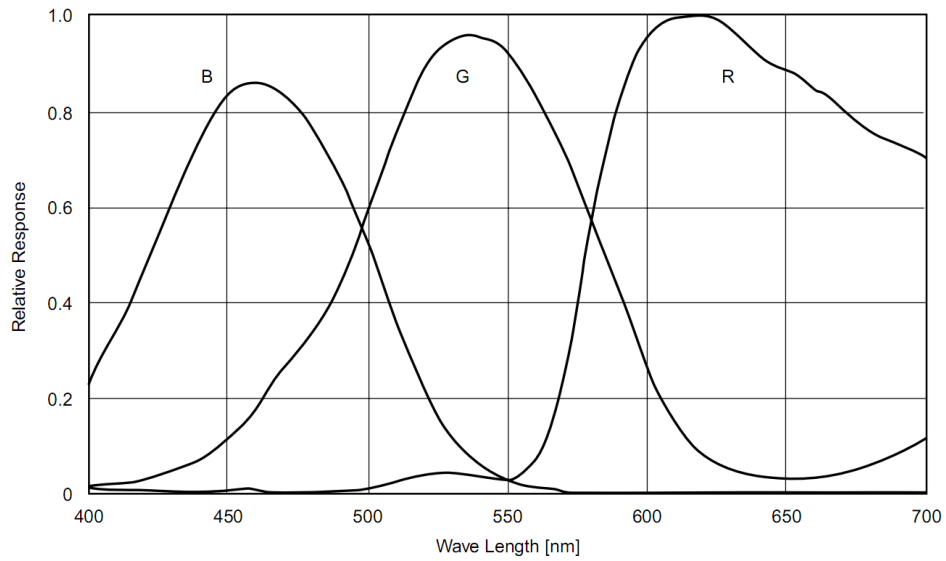

Figure 4-41 MER-200-20GC sensor spectral response

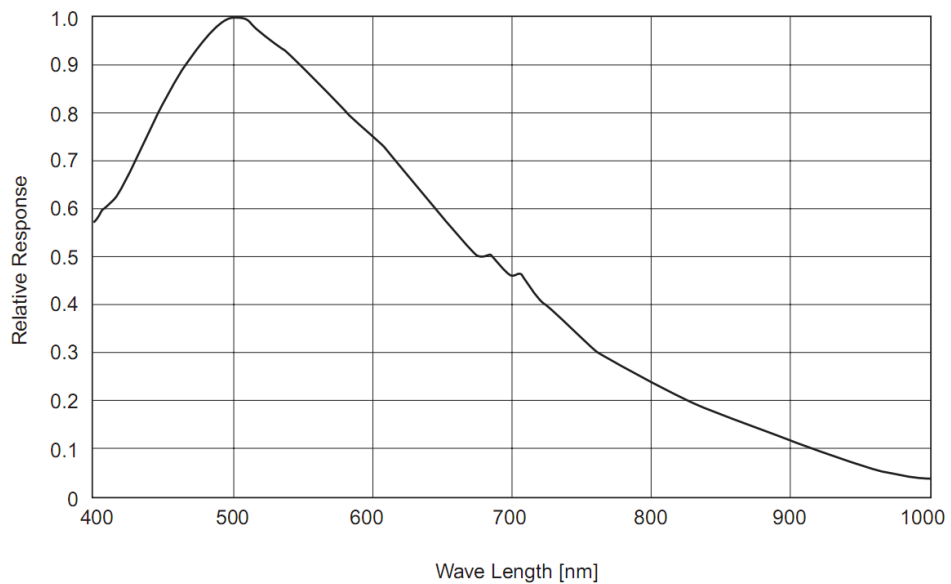

Figure 4-42 MER-200-20GM sensor spectral response

4.29. MER-200-20GC-P / MER-200-20GM-P

4.29.1. Parameters

Specifications	MER-200-20GC-P	MER-200-20GM-P
Resolution	1628×1236	
Sensor Type	Sony ICX274 AL/AQ global shutter CCD	
Max. Image Circle	1/1.8 inch	
Pixel Size	4.4μm×4.4μm	
Frame Rate	20fps@1628×1236	
ADC Bit Depth	12bit	
Pixel Bit Depth	8bit, 12bit	
Shutter Time	20μs~1s	
Gain	0dB~25dB	
Pixel Formats	Bayer RG8/Bayer RG12	Mono8/Mono12
Signal Noise Ratio	38.73dB	39.46dB
Synchronization	Hardware trigger, software trigger	
I/O	1 opto-isolated input line and 1 opto-isolated output line, 2 GPIOs	
Operating Temp.	0°C~45°C	
Storage Temp.	-20°C~70°C	
Operating Humidity	10%~80%	
Camera Power Requirements	PoE (Power over Ethernet, 802.3af compliant) or +12 VDC (± 10%), supplied via the camera's 8-pin Hirose connector	
Power Consumption	<3W@12VDC, <3.75W@PoE	
Lens Mount	C	
Dimensions	38.3mm×29mm×29mm (without lens adapter or connectors)	

Weight	75g
Operating System	Windows XP / Win7 / Win8 / Win8.1 / Win10 / Windows Embedded 32bit and 64bit OS, Ubuntu14.04 / Ubuntu16.04 Linux OS
Data Interface	Fast Ethernet (100Mbit/s) or Gigabit Ethernet (1000Mbit/s)
Programmable Control	Image size, gain, Exposure time, trigger polarity, flash polarity
Conformity	CE, RoHS, FCC, GigE Vision, GenICam, IEEE802.3af

4.29.2. Spectral Response

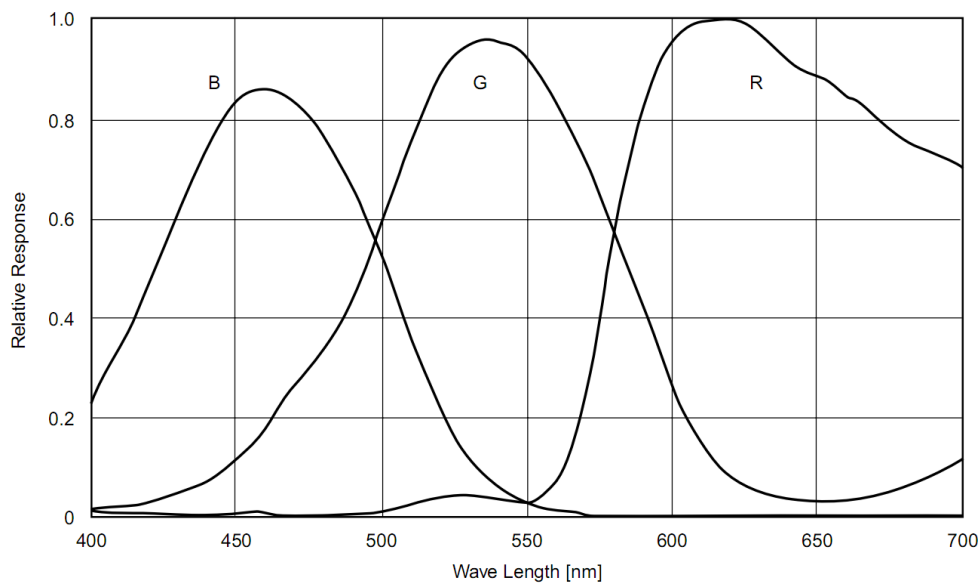

Figure 4-43 MER-200-20GC-P sensor spectral response

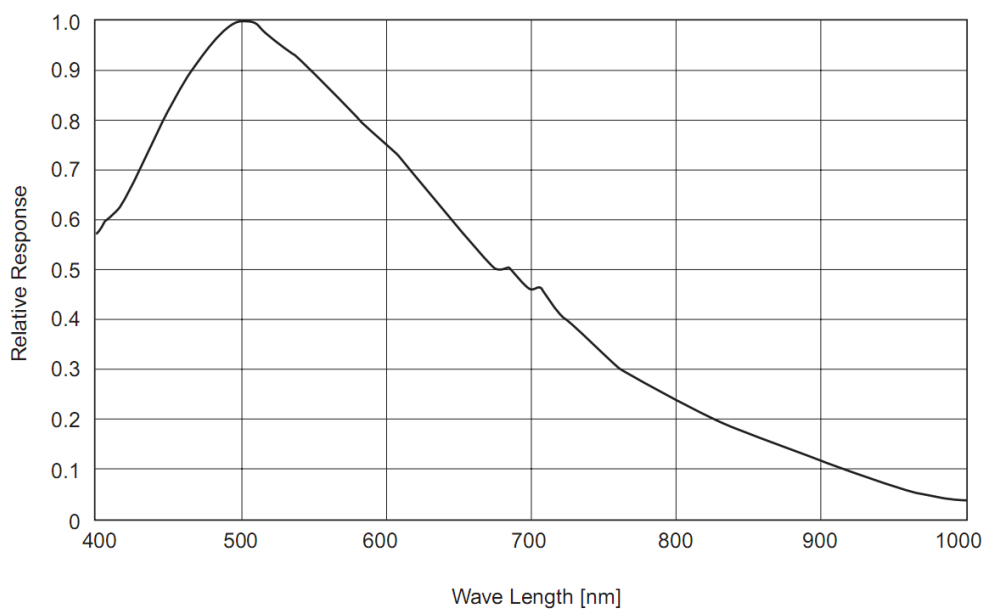

Figure 4-44 MER-200-20GM-P sensor spectral response

4.30. MER-201-25GC / MER-201-25GM

4.30.1. Parameters

Specifications	MER-201-25GC	MER-201-25GM
Resolution	1628×1236	
Sensor Type	Global shutter CCD	
Max. Image Circle	1/1.8 inch	
Pixel Size	4.4μm×4.4μm	
Frame Rate	Default: 25.08fps@1628×1236	
ADC Bit Depth	12bit	
Pixel Bit Depth	8bit, 12bit	
Shutter Time	13μs~1s	
Gain	0dB~25dB	
Pixel Formats	Bayer RG8/Bayer RG12	Mono8/Mono12
Synchronization	Hardware trigger, software trigger	
I/O	1 opto-isolated input line and 1 opto-isolated output line, 2 GPIOs	
Operating Temp.	0°C~45°C	
Storage Temp.	-20°C~70°C	
Operating Humidity	10%~80%	
Power Consumption	<3W@12V	
Lens Mount	C	
Dimensions	29mm×29mm×29mm (without lens adapter or connectors)	
Weight	60g	
Operating System	Windows XP / Win7 / Win8 / Win8.1 / Win10 / Windows Embedded 32bit and 64bit OS, Ubuntu14.04 / Ubuntu16.04 Linux OS	

Data Interface	Fast Ethernet (100Mbit/s) or Gigabit Ethernet (1000Mbit/s)
Programmable Control	Image size, gain, Exposure time, trigger polarity, flash polarity
Conformity	CE, RoHS, FCC, GigE Vision, GenICam

4.30.2. Spectral Response

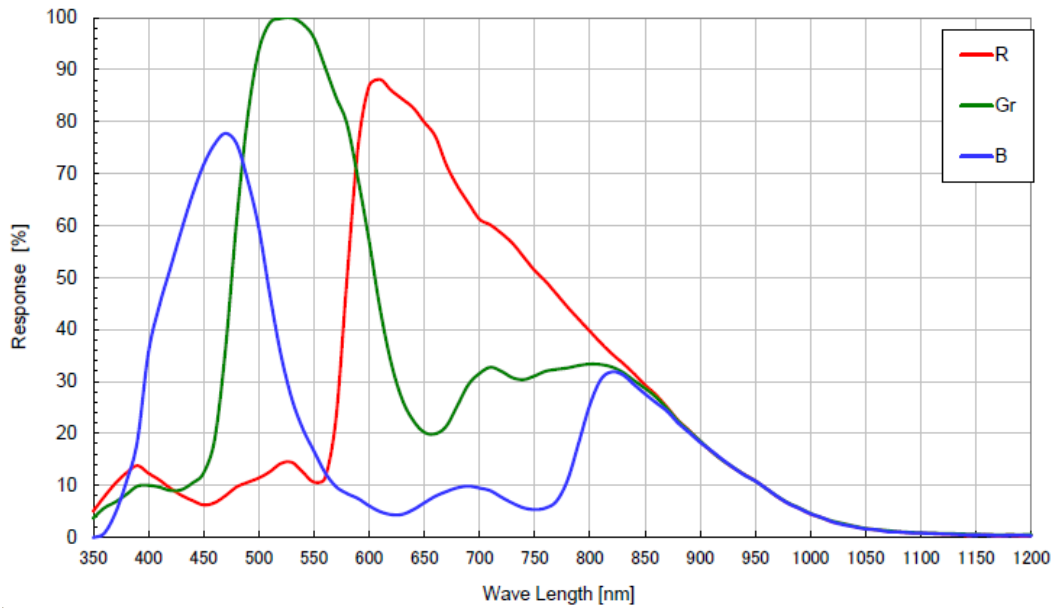

Figure 4-45 MER-201-25GC sensor spectral response

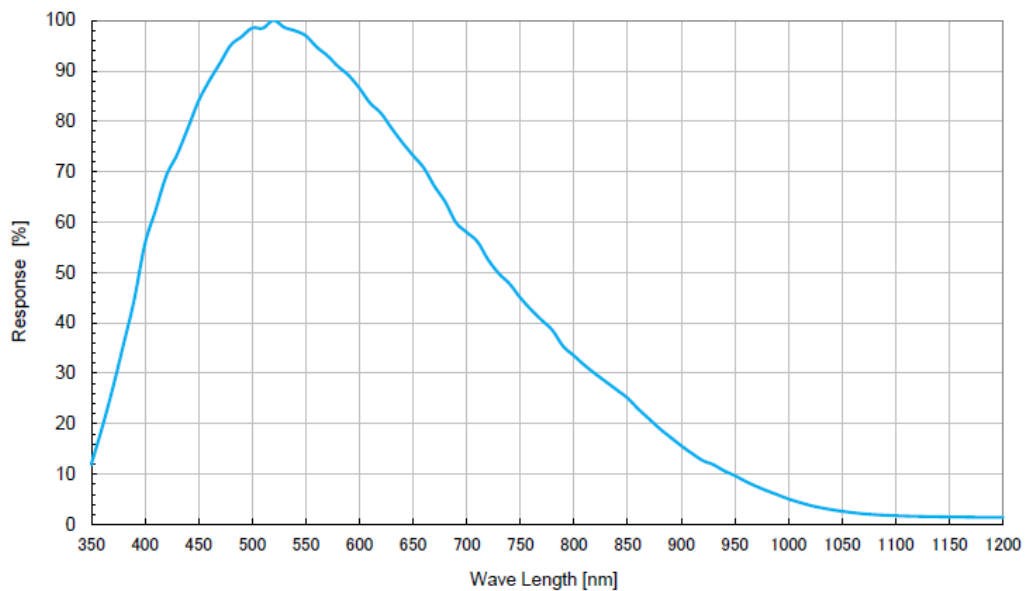

Figure 4-46 MER-201-25GM sensor spectral response

4.31. MER-201-25GC-P / MER-201-25GM-P

4.31.1. Parameters

Specifications	MER-201-25GC-P	MER-201-25GM-P
Resolution	1628×1236	
Sensor Type	Global shutter CCD	
Max. Image Circle	1/1.8 inch	
Pixel Size	4.4μm×4.4μm	
Frame Rate	Default: 25.08fps@1628×1236	
ADC Bit Depth	12bit	
Pixel Bit Depth	8bit, 12bit	
Shutter Time	13μs~1s	
Gain	0dB~25dB	
Pixel Formats	Bayer RG8/Bayer RG12	Mono8/Mono12
Signal Noise Ratio	36.42dB	36.83dB
Synchronization	Hardware trigger, software trigger	
I/O	1 opto-isolated input line and 1 opto-isolated output line, 2 GPIOs	
Operating Temp.	0°C~45°C	
Storage Temp.	-20°C~70°C	
Operating Humidity	10%~80%	
Camera Power Requirements	PoE (Power over Ethernet, 802.3af compliant) or +12 VDC (± 10%), supplied via the camera's 8-pin Hirose connector	
Power Consumption	<3W@12VDC, <3.75W@PoE	
Lens Mount	C	
Dimensions	38.3mm×29mm×29mm (without lens adapter or connectors)	

Weight	75g
Operating System	Windows XP / Win7 / Win8 / Win8.1 / Win10 / Windows Embedded 32bit and 64bit OS, Ubuntu14.04 / Ubuntu16.04 Linux OS
Data Interface	Fast Ethernet (100Mbit/s) or Gigabit Ethernet (1000Mbit/s)
Programmable Control	Image size, gain, Exposure time, trigger polarity, flash polarity
Conformity	CE, RoHS, FCC, GigE Vision, GenICam, IEEE802.3af

4.31.2. Spectral Response

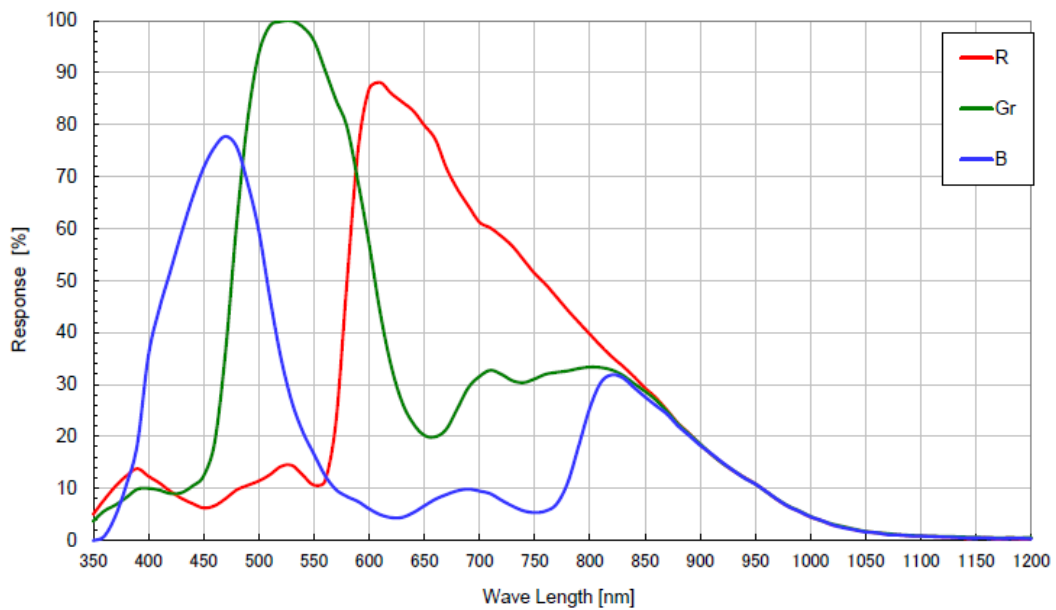

Figure 4-47 MER-201-25GC-P sensor spectral response

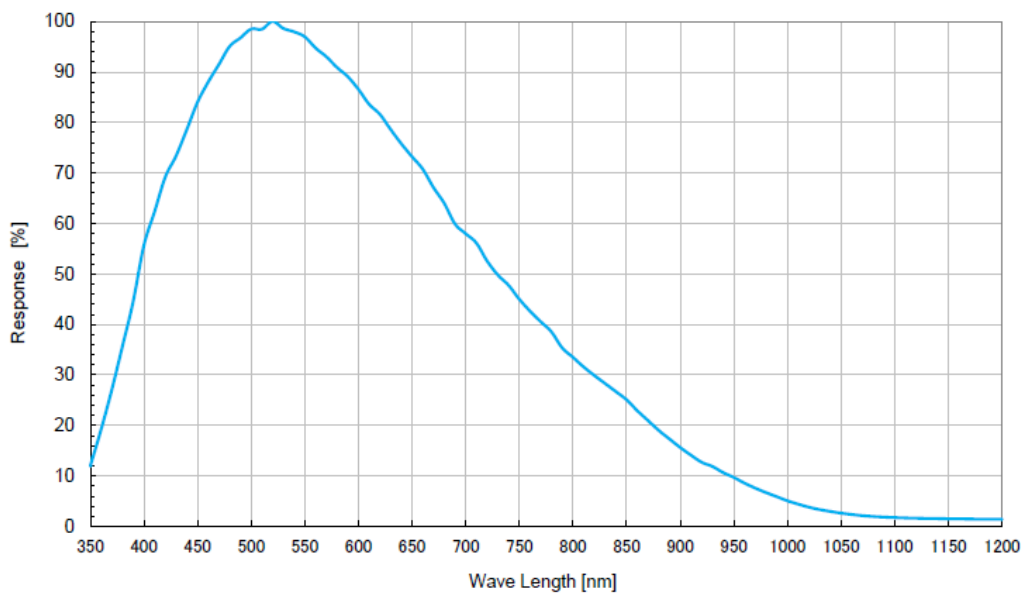

Figure 4-48 MER-201-25GM-P sensor spectral response

4.32. MER-203-30GC-P-L / MER-203-30GC-P-L-F03

4.32.1. Parameters

Specifications	MER-203-30GC-P-L	MER-203-30GC-P-L-F03
Resolution	1920×1080	
Sensor Type	Rolling shutter CMOS	
Max. Image Circle	1/2.8 inch	
Pixel Size	2.9μm×2.9μm	
Frame Rate	30fps	
ADC Bit Depth	10bit	
Pixel Bit Depth	8bit	
Shutter Time	20μs~1s	
Gain	-	
Pixel Formats	Mono8/BayerRG8	
Signal Noise Ratio	39.14dB	
Synchronization	-	
I/O	-	
Operating Temp.	0°C~45°C	
Storage Temp.	-20°C~70°C	
Operating Humidity	10%~80%	
Camera Power Requirements	PoE (Power over Ethernet, 802.3af compliant)	
Power Consumption	<3.75W@PoE	
Lens Mount	C	
Dimensions	38.3mm×29mm×29mm (without lens adapter or connectors)	
Weight	75g	
Software	Windows XP / Win7 / Win8 / Win8.1 / Win10 / Windows Embedded 32bit and 64bit OS, Ubuntu14.04 / Ubuntu16.04 Linux OS	

Data Interface	Fast Ethernet (100Mbit/s) or Gigabit Ethernet (1000Mbit/s)
Programmable Control	Image size, gain, Exposure time, HDR
Conformity	CE, RoHS, FCC, GigE Vision, GenICam, IEEE802.3af

4.32.2. Spectral Response

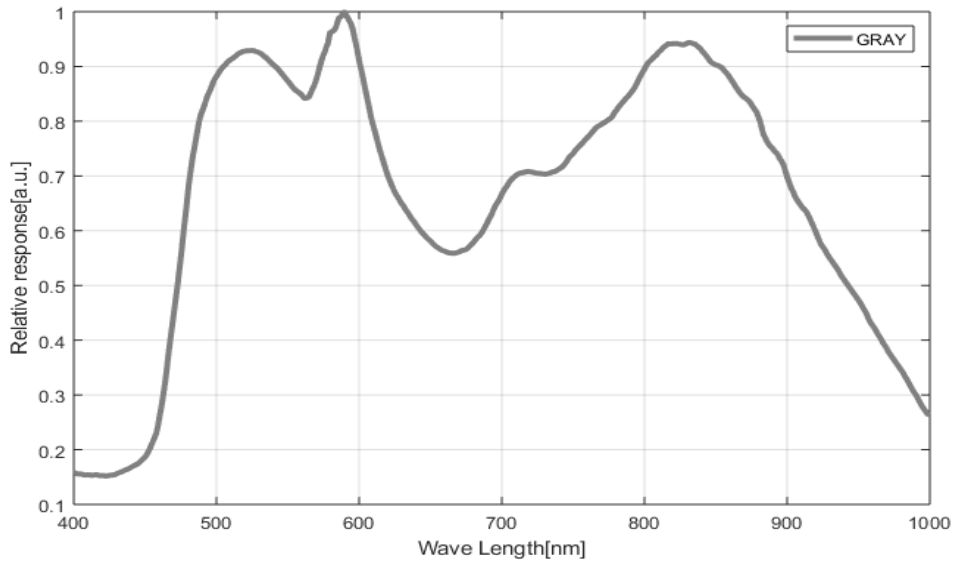

Figure 4-49 MER-203-30GC-P-L, MER-203-30GC-P-L-F03 sensor spectral response

4.33. MER-204-30GC-P-L-F02

4.33.1. Parameters

Specifications	MER-204-30GC-P-L-F02
Resolution	1920×1080
Sensor Type	Rolling shutter CMOS
Max. Image Circle	1/2.8 inch
Pixel Size	2.9μm×2.9μm
Frame Rate	30fps
ADC Bit Depth	10bit
Pixel Bit Depth	8bit
Shutter Time	20μs~1s
Gain	-

Pixel Formats	Mono8/BayerRG8
Signal Noise Ratio	44.52dB
Synchronization	-
I/O	-
Operating Temp.	0°C~45°C
Storage Temp.	-20°C~70°C
Operating Humidity	10%~80%
Camera Power Requirements	PoE (Power over Ethernet, 802.3af compliant)
Power Consumption	<3.75W@PoE
Lens Mount	C
Dimensions	38.3mm×29mm×29mm (without lens adapter or connectors)
Weight	75g
Software	Windows XP / Win7 / Win8 / Win8.1 / Win10 / Windows Embedded 32bit and 64bit OS, Ubuntu14.04 / Ubuntu16.04 Linux OS
Data Interface	Fast Ethernet (100Mbit/s) or Gigabit Ethernet (1000Mbit/s)
Programmable Control	Image size, gain, Exposure time, HDR
Conformity	CE, RoHS, FCC, GigE Vision, GenICam, IEEE802.3af

4.33.2. Spectral Response

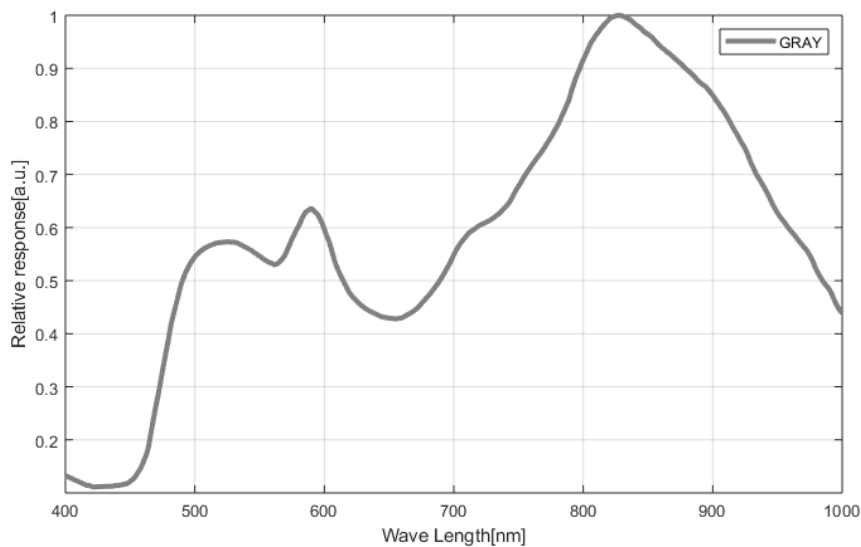

Figure 4-50 MER-204-30GC-P-L-F02 sensor spectral response

4.34. MER-231-41GC / MER-231-41GM

4.34.1. Parameters

Specifications	MER-231-41GC	MER-231-41GM
Resolution	1920×1200	
Sensor Type	Sony IMX249 LQJ global shutter CMOS	
Max. Image Circle	1/1.2 inch	
Pixel Size	5.86μm×5.86μm	
Frame Rate	41fps@1920×1200	
ADC Bit Depth	12bit	
Pixel Bit Depth	8bit, 10bit	
Shutter Time	20μs~1s	
Gain	0dB~24dB	
Pixel Formats	Bayer RG8/Bayer RG10	Mono8/Mono10
Signal Noise Ratio	45.23dB	45.27dB
Synchronization	Hardware trigger, software trigger	
I/O	1 opto-isolated input line and 1 opto-isolated output line, 2 GPIOs	
Operating Temp.	0°C~45°C	
Storage Temp.	-20°C~70°C	
Operating Humidity	10%~80%	
Power Consumption	<3W@12VDC	
Lens Mount	C	
Dimensions	29mm×29mm×29mm (without lens adapter or connectors)	
Weight	60g	

Operating System	Windows XP / Win7 / Win8 / Win8.1 / Win10 / Windows Embedded 32bit and 64bit OS, Ubuntu14.04 / Ubuntu16.04 Linux OS
Data Interface	Fast Ethernet (100Mbit/s) or Gigabit Ethernet (1000Mbit/s)
Programmable Control	Image size, gain, Exposure time, trigger polarity, flash polarity
Conformity	CE, RoHS, FCC, GigE Vision, GenICam

4.34.2. Spectral Response

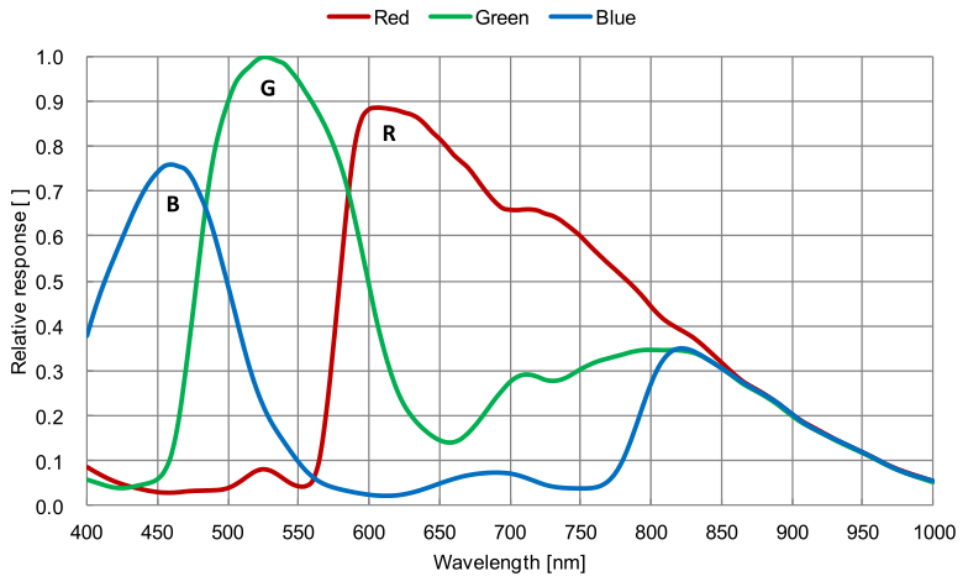

Figure 4-51 MER-231-41GC sensor spectral response

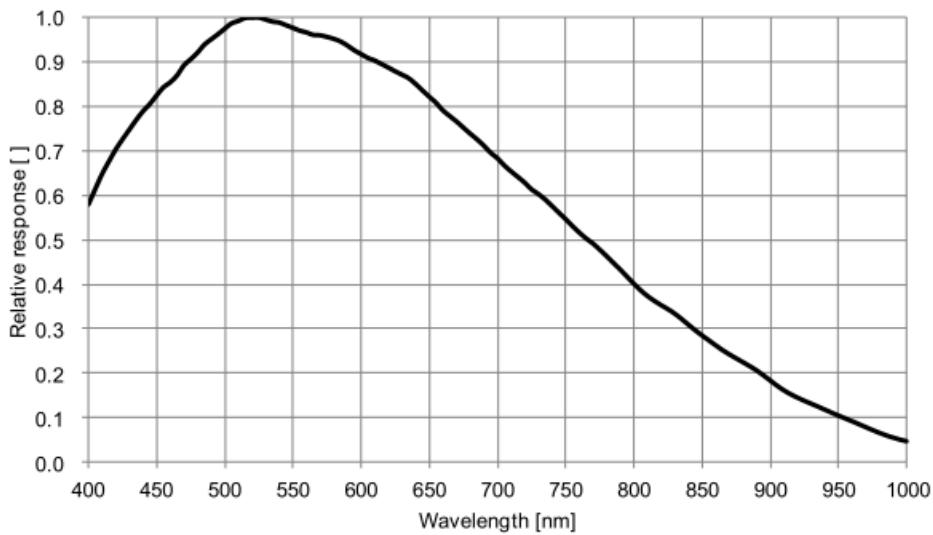

Figure 4-52 MER-231-41GM sensor spectral response

4.35. MER-231-41GC-P / MER-231-41GM-P

4.35.1. Parameters

Specifications	MER-231-41GC-P	MER-231-41GM-P
Resolution	1920×1200	
Sensor Type	Sony IMX249 LQJ global shutter CMOS	
Max. Image Circle	1/1.2 inch	
Pixel Size	5.86μm×5.86μm	
Frame Rate	41fps@1920×1200	
ADC Bit Depth	12bit	
Pixel Bit Depth	8bit, 10bit	
Shutter Time	20μs~1s	
Gain	0dB~24dB	
Pixel Formats	Bayer RG8/Bayer RG10	Mono8/Mono10
Signal Noise Ratio	44.79dB	45.39dB
Synchronization	Hardware trigger, software trigger	
I/O	1 opto-isolated input line and 1 opto-isolated output line, 2 GPIOs	
Operating Temp.	0°C~45°C	
Storage Temp.	-20°C~70°C	
Operating Humidity	10%~80%	
Camera Power Requirements	PoE (Power over Ethernet, 802.3af compliant) or +12 VDC (± 10%), supplied via the camera's 8-pin Hirose connector	
Power Consumption	<3W@12VDC, <3.75W@PoE	
Lens Mount	C	
Dimensions	38.3mm×29mm×29mm (without lens adapter or connectors)	

Weight	75g
Operating System	Windows XP / Win7 / Win8 / Win8.1 / Win10 / Windows Embedded 32bit and 64bit OS, Ubuntu14.04 / Ubuntu16.04 Linux OS
Data Interface	Fast Ethernet (100Mbit/s) or Gigabit Ethernet (1000Mbit/s)
Programmable Control	Image size, gain, Exposure time, trigger polarity, flash polarity
Conformity	CE, RoHS, FCC, GigE Vision, GenICam, IEEE802.3af

4.35.2. Spectral Response

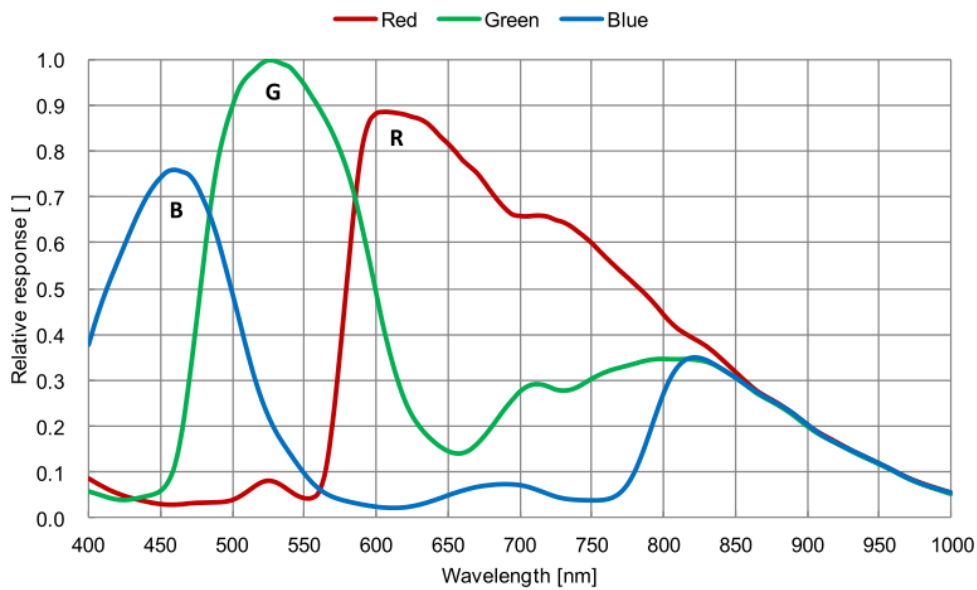

Figure 4-53 MER-231-41GC-P sensor spectral response

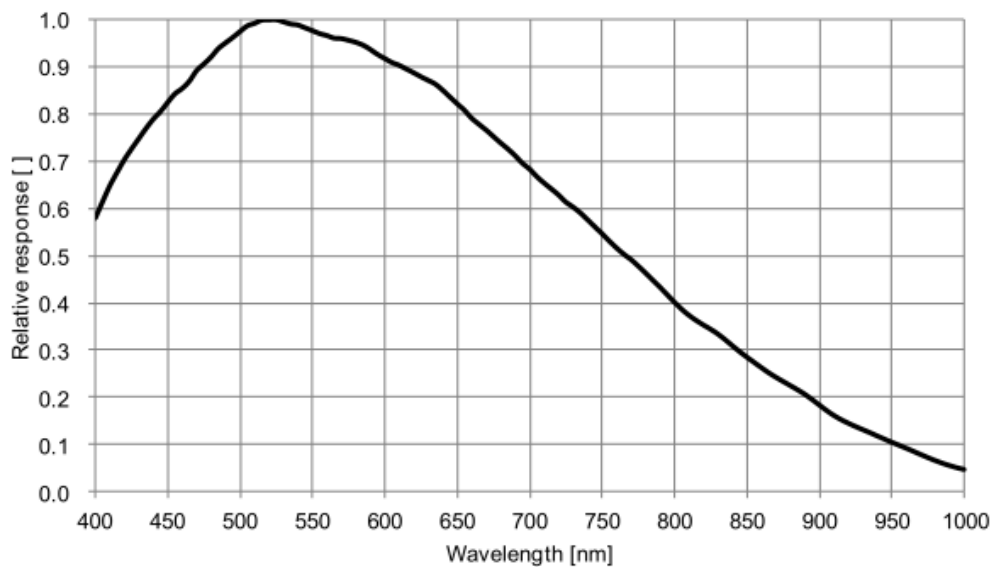

Figure 4-54 MER-231-41GM-P sensor spectral response

4.36. MER-232-48GM-P NIR

4.36.1. Parameters

Specifications	MER-232-48GM-P NIR
Resolution	1920×1200
Sensor Type	Onsemi PYTHON 2000 global shutter CMOS
Max. Image Circle	2/3 inch
Pixel Size	4.8μm×4.8μm
Frame Rate	Default: 46.5fps@1920×1200 Higher frame rates(48fps) are possible if you change the Packet Size to 8192 and the Bandwidth Reserve to 5
ADC Bit Depth	10bit
Pixel Bit Depth	8bit, 10bit
Shutter Time	1μs~1s
Gain	0dB~16dB
Pixel Formats	Mono8/Mono10
Signal Noise Ratio	38dB
Synchronization	Hardware trigger, software trigger
I/O	1 opto-isolated input line and 1 opto-isolated output line, 2 GPIOs
Operating Temp.	0°C~45°C
Storage Temp.	-20°C~70°C
Operating Humidity	10%~80%
Camera Power Requirements	PoE (Power over Ethernet, 802.3af compliant) or +12 VDC (± 10%), supplied via the camera's 8-pin Hirose connector
Power Consumption	<3W@12VDC, <3.75W@PoE
Lens Mount	C

Dimensions	38.3mm×29mm×29mm (without lens adapter or connectors)
Weight	75g
Operating System	Windows XP / Win7 / Win8 / Win8.1 / Win10 / Windows Embedded 32bit and 64bit OS, Ubuntu14.04 / Ubuntu16.04 Linux OS
Data Interface	Fast Ethernet (100Mbit/s) or Gigabit Ethernet (1000Mbit/s)
Programmable Control	Image size, gain, Exposure time, trigger polarity, flash polarity
Conformity	CE, RoHS, FCC, GigE Vision, GenICam, IEEE802.3af

4.36.2. Spectral Response

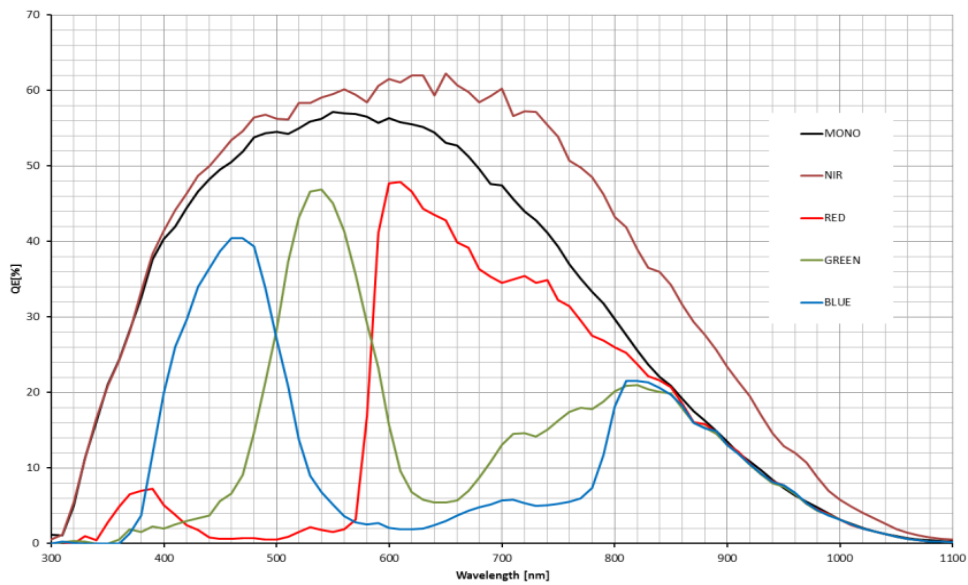

Figure 4-55 MER-232-48GM-P NIR sensor spectral response

4.37. MER-500-14GC / MER-500-14GM

4.37.1. Parameters

Specifications	MER-500-14GC	MER-500-14GM
Resolution	2592×1944	
Sensor Type	ON MT9P006/MT9P031 electronic rolling shutter CMOS	
Max. Image Circle	1/2.5 inch	
Pixel Size	2.2μm×2.2μm	
Frame Rate	14fps@2592×1944	
ADC Bit Depth	12bit	
Pixel Bit Depth	8bit, 10bit	
Shutter Time	36μs~1s	
Gain	0dB~17dB	
Pixel Formats	Bayer GR8/Bayer GR10	Mono8/Mono10
Signal Noise Ratio	36.28dB	33dB
Synchronization	Hardware trigger, software trigger	
I/O	1 opto-isolated input line and 1 opto-isolated output line, 2 GPIOs	
Operating Temp.	0°C~45°C	
Storage Temp.	-20°C~70°C	
Operating Humidity	10%~80%	
Power Consumption	<2W@12V	
Lens Mount	C	
Dimensions	29mm×29mm×29mm (without lens adapter or connectors)	
Weight	60g	

Operating System	Windows XP / Win7 / Win8 / Win8.1 / Win10 / Windows Embedded 32bit and 64bit OS, Ubuntu14.04 / Ubuntu16.04 Linux OS
Data Interface	Fast Ethernet (100Mbit/s) or Gigabit Ethernet (1000Mbit/s)
Programmable Control	Image size, gain, Exposure time, trigger polarity, flash polarity
Conformity	CE, RoHS, FCC, GigE Vision, GenICam

4.37.2. Spectral Response

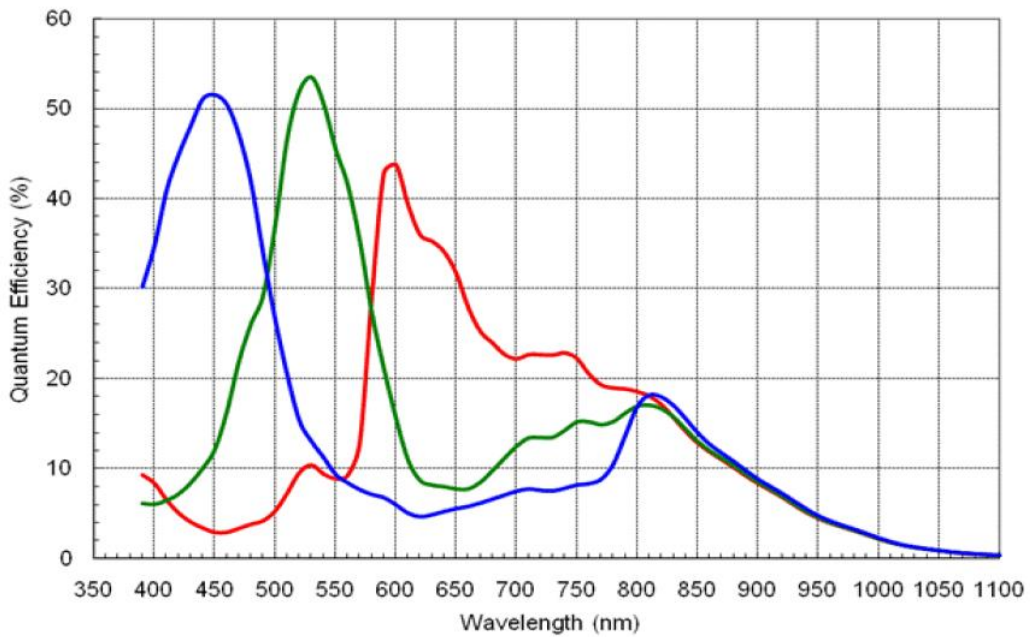

Figure 4-56 MER-500-14GC sensor spectral response

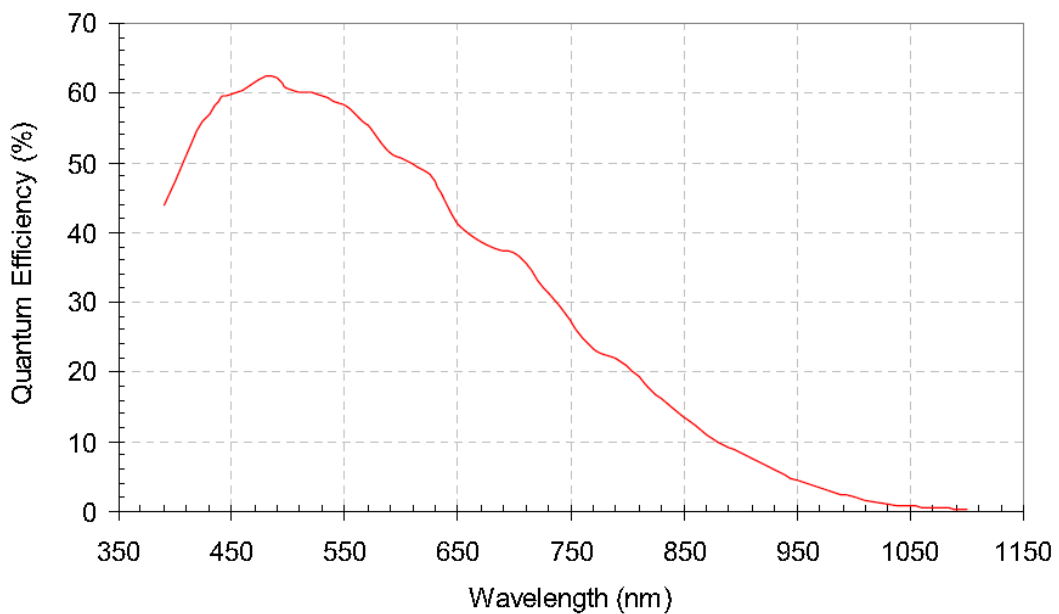

Figure 4-57 MER-500-14GM sensor spectral response

4.38. MER-500-14GC-P / MER-500-14GM-P

4.38.1. Parameters

Specifications	MER-500-14GC-P	MER-500-14GM-P
Resolution	2592×1944	
Sensor Type	ON MT9P006/MT9P031 electronic rolling shutter CMOS	
Max. Image Circle	1/2.5 inch	
Pixel Size	2.2μm×2.2μm	
Frame Rate	14fps@2592×1944	
ADC Bit Depth	12bit	
Pixel Bit Depth	8bit, 10bit	
Shutter Time	36μs~1s	
Gain	0dB~17dB	
Pixel Formats	Bayer GR8/Bayer GR10	Mono8/Mono10
Signal Noise Ratio	35.79dB	36.11dB
Synchronization	Hardware trigger, software trigger	
I/O	1 opto-isolated input line and 1 opto-isolated output line, 2 GPIOs	
Operating Temp.	0°C~45°C	
Storage Temp.	-20°C~70°C	
Operating Humidity	10%~80%	
Camera Power Requirements	PoE (Power over Ethernet, 802.3af compliant) or +12 VDC (± 10%), supplied via the camera's 8-pin Hirose connector	
Power Consumption	<2W@12VDC, <2.5W@PoE	
Lens Mount	C	
Dimensions	38.3mm×29mm×29mm (without lens adapter or connectors)	

Weight	75g
Operating System	Windows XP / Win7 / Win8 / Win8.1 / Win10 / Windows Embedded 32bit and 64bit OS, Ubuntu14.04 / Ubuntu16.04 Linux OS
Data Interface	Fast Ethernet (100Mbit/s) or Gigabit Ethernet (1000Mbit/s)
Programmable Control	Image size, gain, Exposure time, trigger polarity, flash polarity
Conformity	CE, RoHS, FCC, GigE Vision, GenICam, IEEE802.3af, KCC

4.38.2. Spectral Response

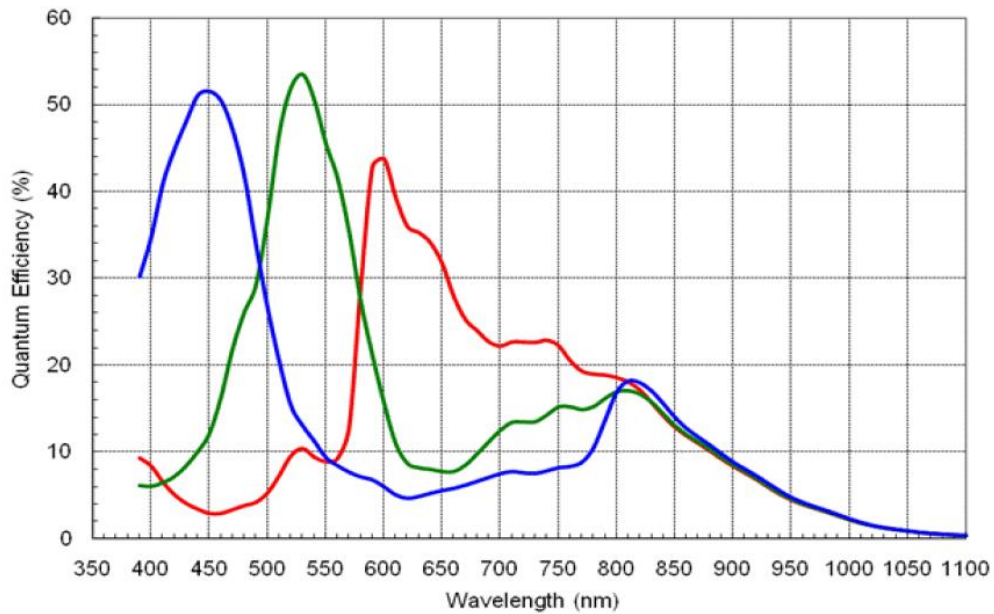

Figure 4-58 MER-500-14GC-P sensor spectral response

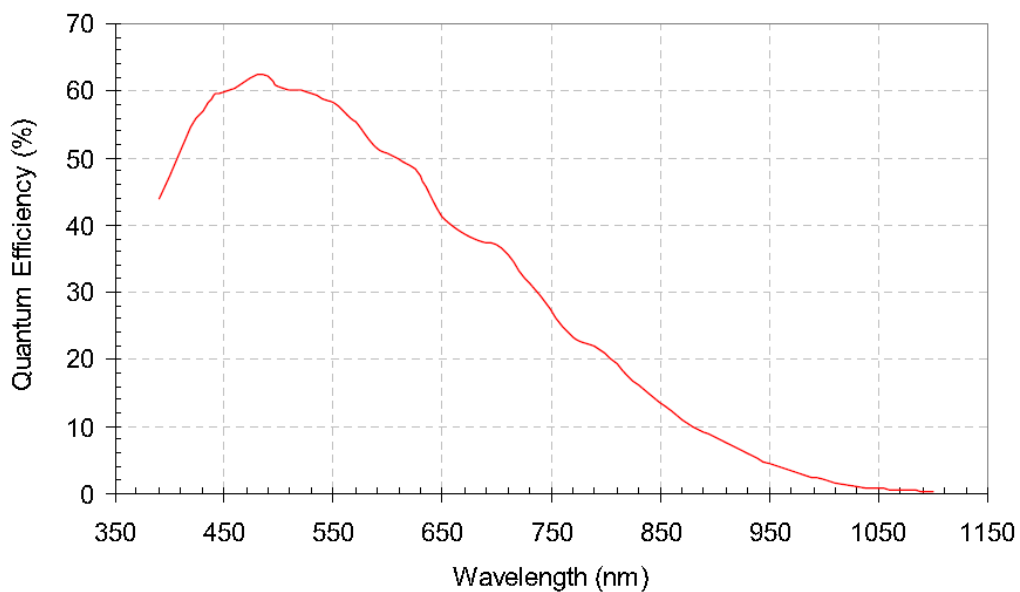

Figure 4-59 MER-500-14GM-P sensor spectral response

4.39. MER-503-20GC / MER-503-20GM

4.39.1. Parameters

Specifications	MER-503-20GC	MER-503-20GM
Resolution	2448x2048	
Sensor Type	Global shutter CMOS	
Max. Image Circle	Diagonal 11.1 mm(2/3-type)	
Pixel Size	3.45 μ m \times 3.45 μ m	
Frame Rate	20fps@2448x2048	
ADC Bit Depth	12bit	
Pixel Bit Depth	8bit, 10bit	
Shutter Time	20 μ s~1s	
Gain	0dB~23.9dB	
Pixel Formats	Bayer RG8/Bayer RG10	Mono8/Mono10
Signal Noise Ratio	40.74dB	40.89dB
Synchronization	Hardware trigger, software trigger	
I/O	1 opto-isolated input line and 1 opto-isolated output line, 2 GPIOs	
Operating Temp.	0°C~45°C	
Storage Temp.	-20°C~70°C	
Operating Humidity	10%~80%	
Power Consumption	<3W@12VDC	
Lens Mount	C	
Dimensions	29mm \times 29mm \times 29mm (without lens adapter or connectors)	
Weight	60g	

Operating System	Windows XP / Win7 / Win8 / Win8.1 / Win10 / Windows Embedded 32bit and 64bit OS, Ubuntu14.04 / Ubuntu16.04 Linux OS
Data Interface	Fast Ethernet (100Mbit/s) or Gigabit Ethernet (1000Mbit/s)
Programmable Control	Image size, gain, Exposure time, trigger polarity, flash polarity
Conformity	CE, RoHS, FCC, GigE Vision, GenICam, IEEE802.3af

4.39.2. Spectral Response

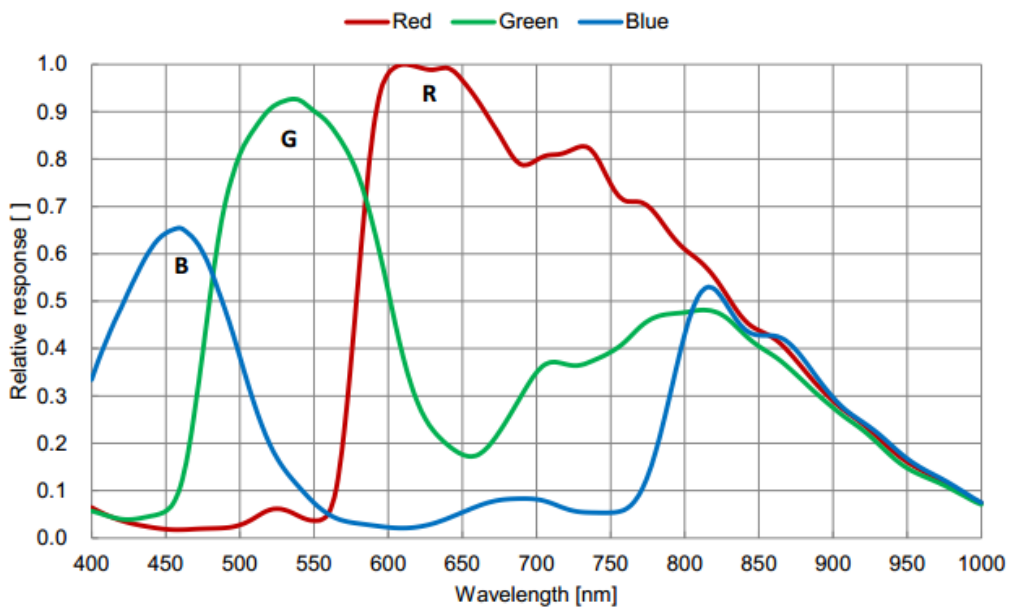

Figure 4-60 MER-503-20GC sensor spectral response

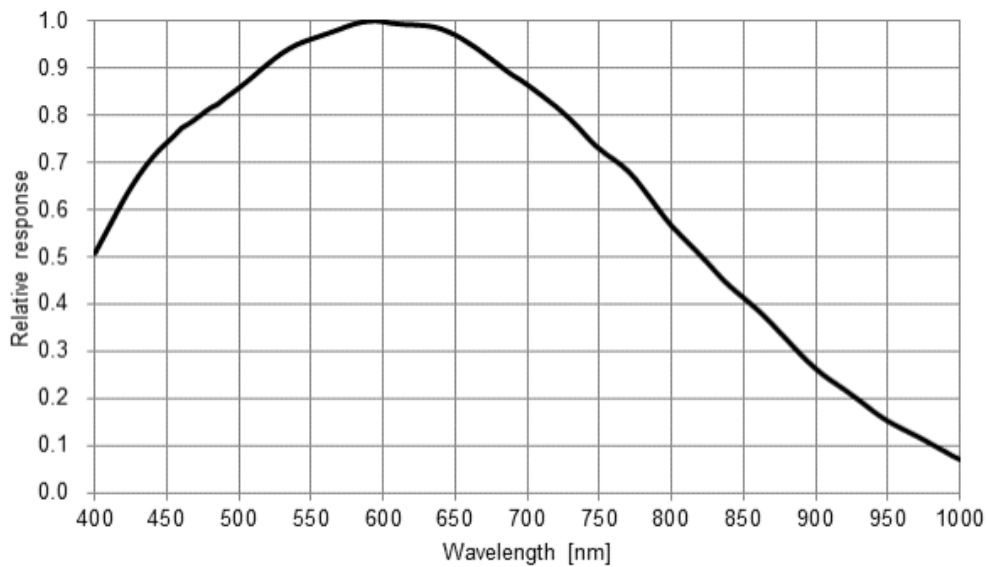

Figure 4-61 MER-503-20GM sensor spectral response

4.40. MER-503-20GC-P / MER-503-20GM-P

4.40.1. Parameters

Specifications	MER-503-20GC-P	MER-503-20GM-P
Resolution	2448x2048	
Sensor Type	Global shutter CMOS	
Max. Image Circle	Diagonal 11.1 mm(2/3-type)	
Pixel Size	3.45μm×3.45μm	
Frame Rate	20fps@2448x2048	
ADC Bit Depth	12bit	
Pixel Bit Depth	8bit, 10bit	
Shutter Time	20μs~1s	
Gain	0dB~23.9dB	
Pixel Formats	Bayer RG8/Bayer RG10	Mono8/Mono10
Signal Noise Ratio	40.63dB	39dB
Synchronization	Hardware trigger, software trigger	
I/O	1 opto-isolated input line and 1 opto-isolated output line, 2 GPIOs	
Operating Temp.	0°C~45°C	
Storage Temp.	-20°C~70°C	
Operating Humidity	10%~80%	
Camera Power Requirements	PoE (Power over Ethernet, 802.3af compliant) or +12 VDC (± 10%), supplied via the camera's 8-pin Hirose connector	
Power Consumption	<3W@12VDC, <3.75W@PoE	
Lens Mount	C	
Dimensions	38.3mm×29mm×29mm (without lens adapter or connectors)	

Weight	75g
Operating System	Windows XP / Win7 / Win8 / Win8.1 / Win10 / Windows Embedded 32bit and 64bit OS, Ubuntu14.04 / Ubuntu16.04 Linux OS
Data Interface	Fast Ethernet (100Mbit/s) or Gigabit Ethernet (1000Mbit/s)
Programmable Control	Image size, gain, Exposure time, trigger polarity, flash polarity
Conformity	CE, RoHS, FCC, GigE Vision, GenICam, IEEE802.3af, KCC

4.40.2. Spectral Response

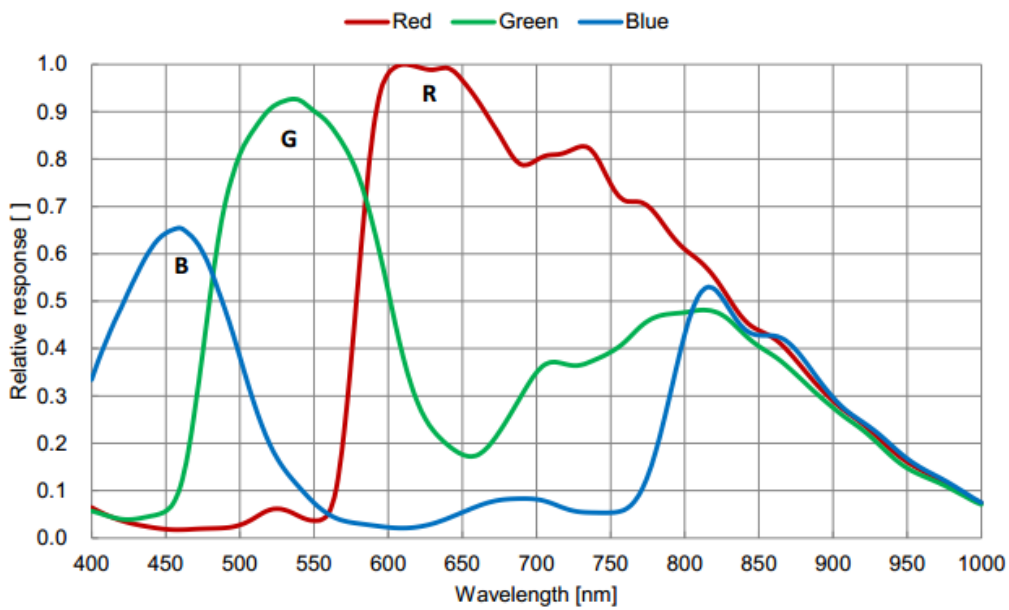

Figure 4-62 MER-503-20GC-P sensor spectral response

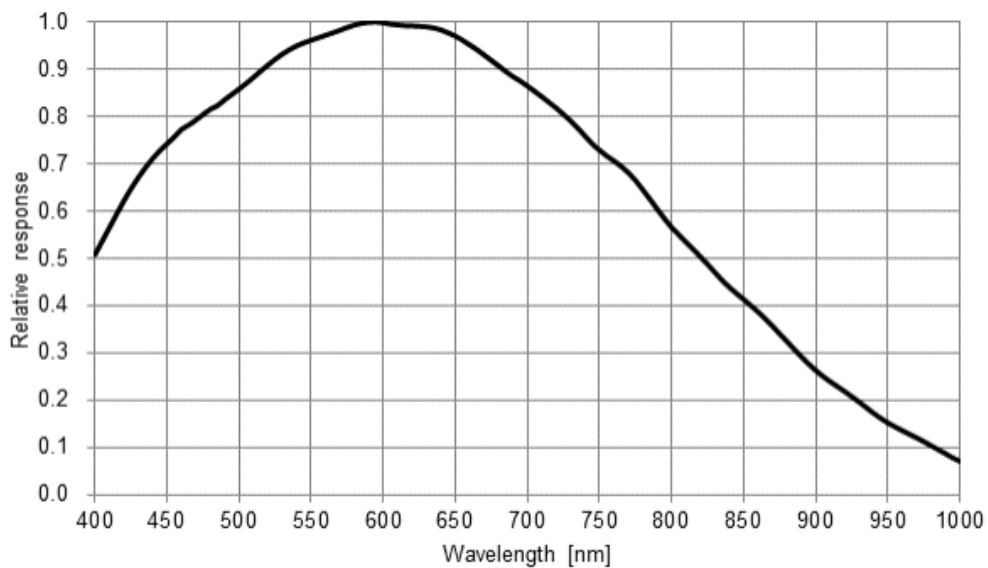

Figure 4-63 MER-503-20GM-P sensor spectral response

4.41. MER-504-10GC-P / MER-504-10GM-P

4.41.1. Parameters

Specifications	MER-504-10GC-P	MER-504-10GM-P
Resolution	2448x2048	
Sensor Type	Global shutter CCD	
Max. Image Circle	2/3-type Progressive Scan B/W CCD Area Sensor	
Pixel Size	3.45μm×3.45μm	
Frame Rate	10fps@2448x2048	
ADC Bit Depth	12bit	
Pixel Bit Depth	8bit, 12bit	
Shutter Time	20μs~1s	
Gain	0dB~25dB	
Pixel Formats	Bayer RG8/Bayer RG12	Mono8/Mono12
Signal Noise Ratio	37.44dB	38.65dB
Synchronization	Hardware trigger, software trigger	
I/O	1 opto-isolated input line and 1 opto-isolated output line, 2 GPIOs	
Operating Temp.	0°C~45°C	
Storage Temp.	-20°C~70°C	
Operating Humidity	10%~80%	
Camera Power Requirements	PoE (Power over Ethernet, 802.3af compliant) or +12 VDC (± 10%), supplied via the camera's 8-pin Hirose connector	
Power Consumption	<3W@12VDC, <3.75W@PoE	
Lens Mount	C	
Dimensions	38.3mm×29mm×29mm (without lens adapter or connectors)	

Weight	75g
Operating System	Windows XP / Win7 / Win8 / Win8.1 / Win10 / Windows Embedded 32bit and 64bit OS, Ubuntu14.04 / Ubuntu16.04 Linux OS
Data Interface	Fast Ethernet (100Mbit/s) or Gigabit Ethernet (1000Mbit/s)
Programmable Control	Image size, gain, Exposure time, trigger polarity, flash polarity
Conformity	CE, RoHS, FCC, GigE Vision, GenICam, IEEE802.3af

4.41.2. Spectral Response

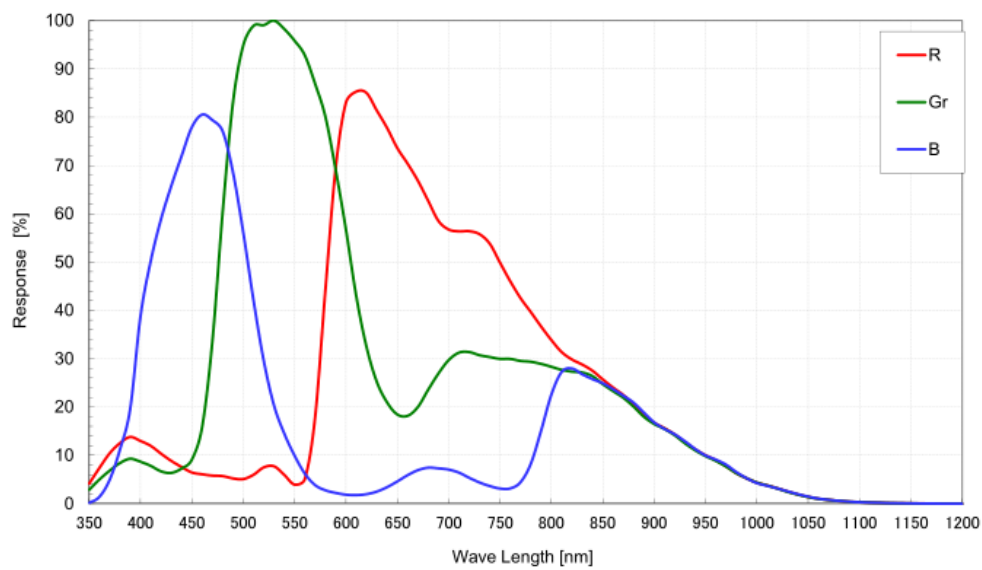

Figure 4-64 MER-504-10GC-P sensor spectral response

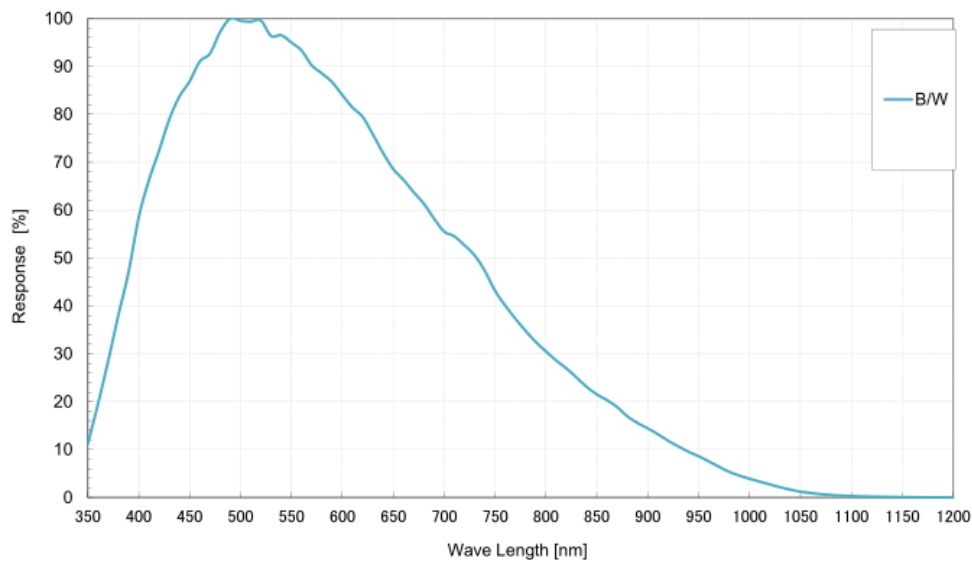

Figure 4-65 MER-504-10GM-P sensor spectral response

4.42. MER-530-20GM-P NIR

4.42.1. Parameters

Specifications	MER-530-20GM-P NIR
Resolution	2592×2048
Sensor Type	Onsemi PYTHON 5000 global shutter CMOS
Max. Image Circle	1 inch
Pixel Size	4.8μm×4.8μm
Frame Rate	20fps@2592×2048
ADC Bit Depth	10bit
Pixel Bit Depth	8bit, 10bit
Shutter Time	5μs~1s
Gain	0dB~16dB
Pixel Formats	Mono8/Mono10
Signal Noise Ratio	38.1dB
Synchronization	Hardware trigger, software trigger
I/O	1 opto-isolated input line and 1 opto-isolated output line, 2 GPIOs
Operating Temp.	0°C~45°C
Storage Temp.	-20°C~70°C
Operating Humidity	10%~80%
Camera Power Requirements	PoE (Power over Ethernet, 802.3af compliant) or +12 VDC (± 10%), supplied via the camera's 8-pin Hirose connector
Power Consumption	<3W@12VDC, <3.75W@PoE
Lens Mount	C
Dimensions	38.3mm×29mm×29mm (without lens adapter or connectors)
Weight	75g
Operating System	Windows XP / Win7 / Win8 / Win8.1 / Win10 / Windows Embedded 32bit and 64bit OS, Ubuntu14.04 / Ubuntu16.04 Linux OS

Data Interface	Fast Ethernet (100Mbit/s) or Gigabit Ethernet (1000Mbit/s)
Programmable Control	Image size, gain, Exposure time, trigger polarity, flash polarity
Conformity	CE, RoHS, FCC, GigE Vision, GenICam, IEEE802.3af

4.42.2. Spectral Response

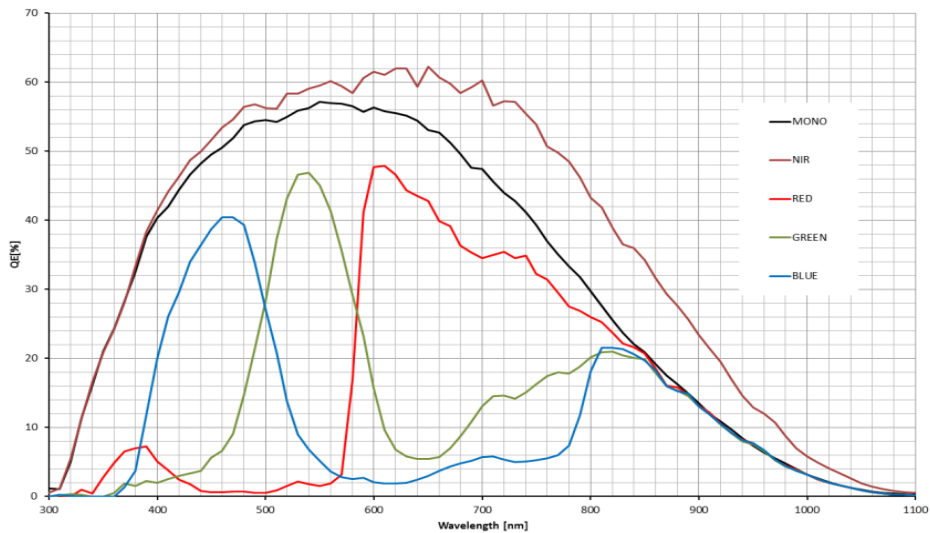

Figure 4-66 MER-530-20GM-P NIR sensor spectral response

4.43. MER-531-20GC-P / MER-531-20GM-P

4.43.1. Parameters

Specifications	MER-531-20GC-P	MER-531-20GM-P
Resolution	2592x2048	
Sensor Type	Onsemi PYTHON 5000 global shutter CMOS	
Max. Image Circle	1 inch	
Pixel Size	4.8μm×4.8μm	
Frame Rate	20fps@2592x2048	
ADC Bit Depth	10bit	
Pixel Bit Depth	8bit, 10bit	
Shutter Time	5μs~1s	
Gain	0dB~16dB	

Pixel Formats	Bayer RG8/Bayer RG10	Mono8/Mono10
Signal Noise Ratio	38.63dB	40dB
Synchronization	Hardware trigger, software trigger	
I/O	1 opto-isolated input line and 1 opto-isolated output line, 2 GPIOs	
Operating Temp.	0°C~45°C	
Storage Temp.	-20°C~70°C	
Operating Humidity	10%~80%	
Camera Power Requirements	PoE (Power over Ethernet, 802.3af compliant) or +12 VDC (± 10%), supplied via the camera's 8-pin Hirose connector	
Power Consumption	<3W @12VDC, <3.75W @PoE	
Lens Mount	C	
Dimensions	38.3mm×29mm×29mm (without lens adapter or connectors)	
Weight	75g	
Operating System	Windows XP / Win7 / Win8 / Win8.1 / Win10 / Windows Embedded 32bit and 64bit OS, Ubuntu14.04 / Ubuntu16.04 Linux OS	
Data Interface	Fast Ethernet (100Mbit/s) or Gigabit Ethernet (1000Mbit/s)	
Programmable Control	Image size, gain, Exposure time, trigger polarity, flash polarity	
Conformity	CE, RoHS, FCC, GigE Vision, GenICam, IEEE802.3af	

4.43.2. Spectral Response

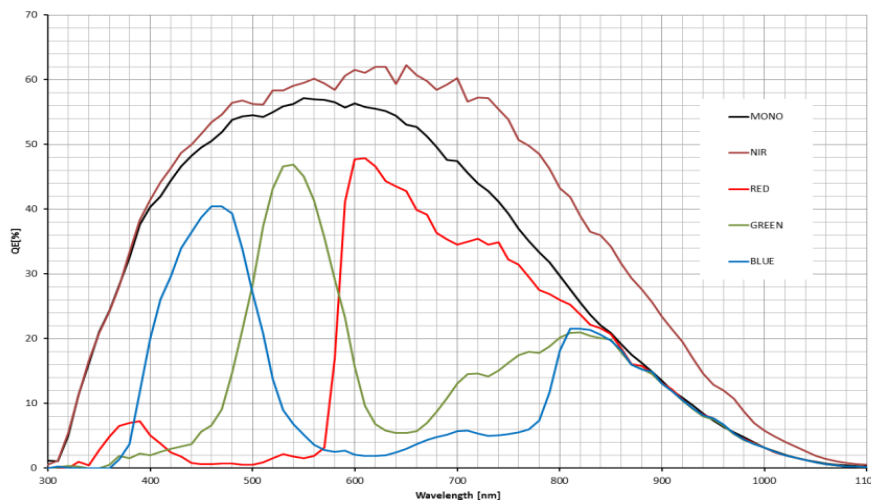

Figure 4-67 MER-531-20GC-P / MER-531-20GM-P sensor spectral response

4.44. MER-630-16GC / MER-630-16GM

4.44.1. Parameters

Specifications	MER-630-16GC	MER-630-16GC
Resolution	3088x2064	
Sensor Type	Sony IMX178 rolling shutter CMOS	
Max. Image Circle	1/1.8 inch	
Pixel Size	2.4μm×2.4μm	
Frame Rate	Default: 16.8fps@3088x2064	
ADC Bit Depth	12bit	
Pixel Bit Depth	8bit, 12bit	
Shutter Time	19μs~1s	
Gain	0dB~24dB	
Pixel Formats	Bayer RG8/Bayer RG12	Mono8/Mono12
Signal Noise Ratio	40.25dB	40.28dB
Synchronization	Hardware trigger, software trigger	
I/O	1 opto-isolated input line and 1 opto-isolated output line, 2 GPIOs	
Operating Temp.	0°C~45°C	
Storage Temp.	-20°C~70°C	
Operating Humidity	10%~80%	
Power Consumption	<2W@12VDC	
Lens Mount	C	
Dimensions	29mm×29mm×29mm (without lens adapter or connectors)	
Weight	60g	

Operating System	Windows XP / Win7 / Win8 / Win8.1 / Win10 / Windows Embedded 32bit and 64bit OS, Ubuntu14.04 / Ubuntu16.04 Linux OS
Data Interface	Fast Ethernet (100Mbit/s) or Gigabit Ethernet (1000Mbit/s)
Programmable Control	Image size, gain, Exposure time, trigger polarity, flash polarity
Conformity	CE, RoHS, FCC, GigE Vision, GenICam

4.44.2. Spectral Response

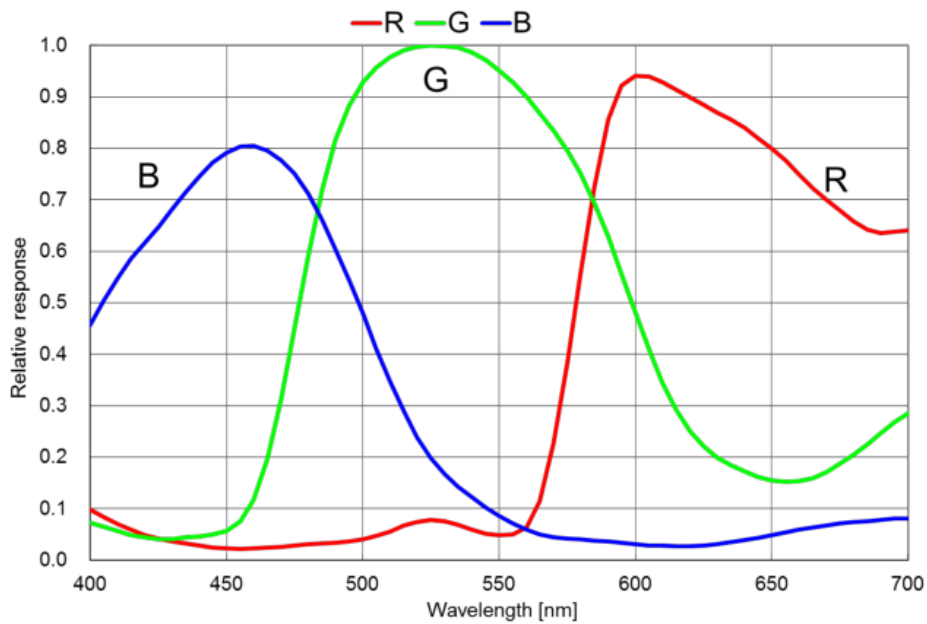

Figure 4-68 MER-630-16GC sensor spectral response

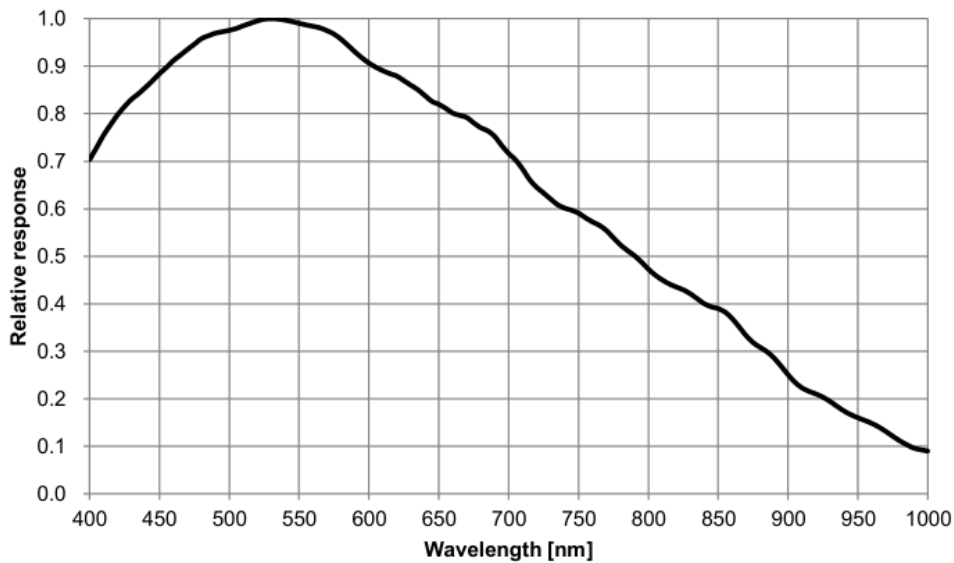

Figure 4-69 MER-630-16GM sensor spectral response

4.45. MER-630-16GC-P / MER-630-16GM-P

4.45.1. Parameters

Specifications	MER-630-16GC-P	MER-630-16GM-P
Resolution	3088×2064	
Sensor Type	Sony IMX178 rolling shutter CMOS	
Max. Image Circle	1/1.8 inch	
Pixel Size	2.4μm×2.4μm	
Frame Rate	Default: 16.8fps@3088×2064	
ADC Bit Depth	12bit	
Pixel Bit Depth	8bit, 12bit	
Shutter Time	19μs~1s	
Gain	0dB~24dB	
Pixel Formats	Bayer RG8/Bayer RG12	Mono8/Mono12
Signal Noise Ratio	40.22dB	40.22dB
Synchronization	Hardware trigger, software trigger	
I/O	1 opto-isolated input line and 1 opto-isolated output line, 2 GPIOs	
Operating Temp.	0°C~45°C	
Storage Temp.	-20°C~70°C	
Operating Humidity	10%~80%	
Camera Power Requirements	PoE (Power over Ethernet, 802.3af compliant) or +12 VDC (± 10%), supplied via the camera's 8-pin Hirose connector	
Power Consumption	<3W@12VDC, <3.75W@PoE	
Lens Mount	C	
Dimensions	38.3mm×29mm×29mm (without lens adapter or connectors)	

Weight	75g
Operating System	Windows XP / Win7 / Win8 / Win8.1 / Win10 / Windows Embedded 32bit and 64bit OS, Ubuntu14.04 / Ubuntu16.04 Linux OS
Data Interface	Fast Ethernet (100Mbit/s) or Gigabit Ethernet (1000Mbit/s)
Programmable Control	Image size, gain, Exposure time, trigger polarity, flash polarity
Conformity	CE, RoHS, FCC, GigE Vision, GenICam, IEEE802.3af

4.45.2. Spectral Response

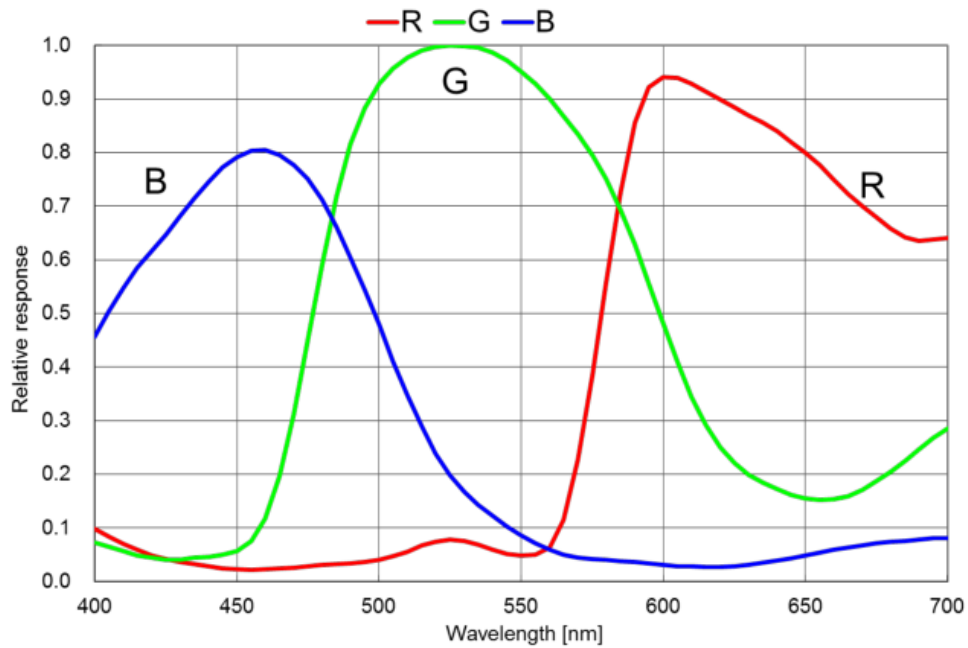

Figure 4-70 MER-630-16GC-P sensor spectral response

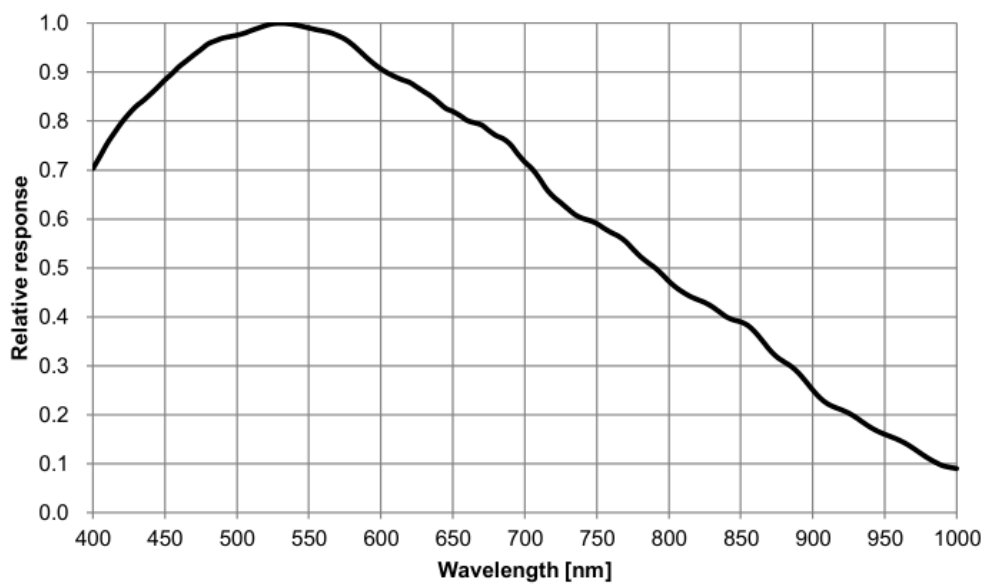

Figure 4-71 MER-630-16GM-P sensor spectral response

4.46. MER-1070-10GC / MER-1070-10GM

4.46.1. Parameters

Specifications	MER-1070-10GC	MER-1070-10GM
Resolution	3840×2748	
Sensor Type	MT9J003 electronic rolling shutter CMOS	
Max. Image Circle	1/2.3 inch	
Pixel Size	1.67μm×1.67μm	
Frame Rate	10fps@3840×2748	
ADC Bit Depth	12bit	
Pixel Bit Depth	8bit, 12bit	
Shutter Time	42μs~1s	
Gain	0dB~25.9dB	
Pixel Formats	Bayer GR8/Bayer GR12	Mono8/Mono12
Signal Noise Ratio	36.67dB	31dB
Synchronization	Hardware trigger, software trigger	
I/O	1 opto-isolated input line and 1 opto-isolated output line, 2 GPIOs	
Operating Temp.	0°C~45°C	
Storage Temp.	-20°C~70°C	
Operating Humidity	10%~80%	
Power Consumption	< 3W@12V	
Lens Mount	C	
Dimensions	29mm×29mm×29mm (without lens adapter or connectors)	
Weight	60g	

Operating System	Windows XP / Win7 / Win8 / Win8.1 / Win10 / Windows Embedded 32bit and 64bit OS, Ubuntu14.04 / Ubuntu16.04 Linux OS
Data Interface	Fast Ethernet (100Mbit/s) or Gigabit Ethernet (1000Mbit/s)
Programmable Control	Image size, gain, Exposure time, trigger polarity, flash polarity
Conformity	CE, RoHS, FCC, GigE Vision, GenICam

4.46.2. Spectral Response

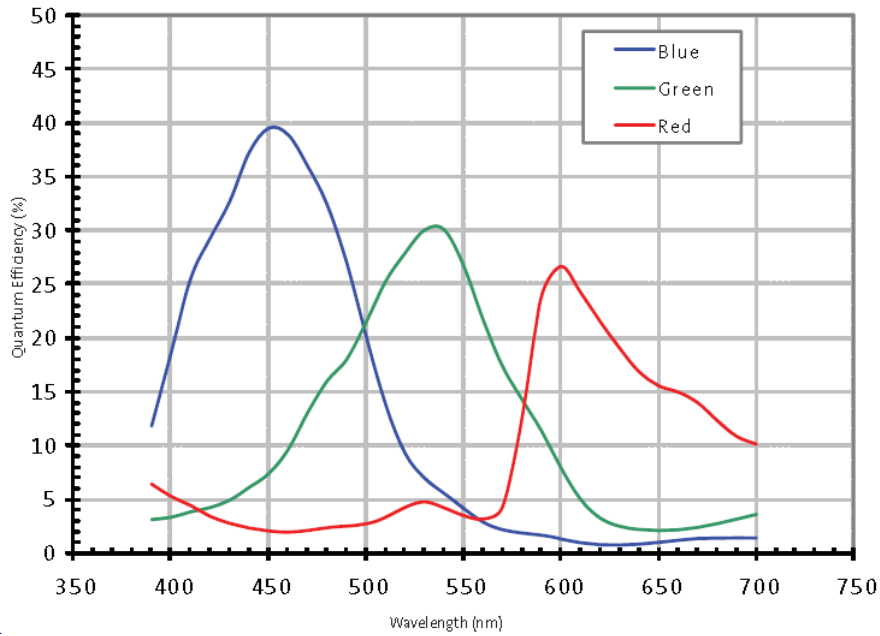

Figure 4-72 MER-1070-10GC sensor spectral response

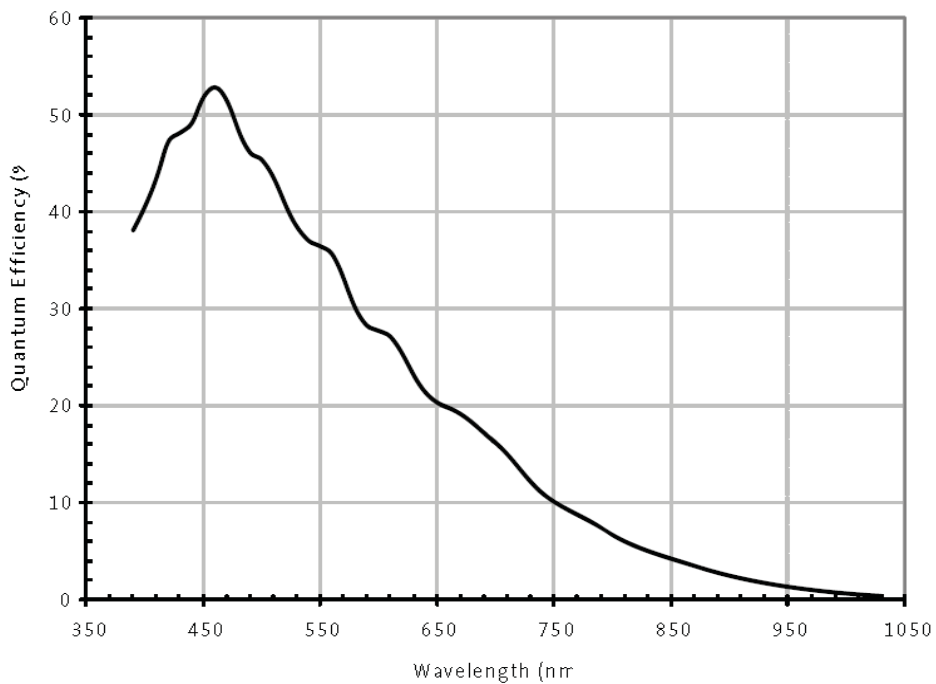

Figure 4-73 MER-1070-10GM sensor spectral response

4.47. MER-1070-10GC-P / MER-1070-10GM-P

4.47.1. Parameters

Specifications	MER-1070-10GC-P	MER-1070-10GM-P
Resolution	3840×2748	
Sensor Type	MT9J003 electronic rolling shutter CMOS	
Max. Image Circle	1/2.3 inch	
Pixel Size	1.67μm×1.67μm	
Frame Rate	10fps@3840×2748	
ADC Bit Depth	12bit	
Pixel Bit Depth	8bit, 12bit	
Shutter Time	42μs~1s	
Gain	0dB~25.9dB	
Pixel Formats	Bayer GR8/Bayer GR12	Mono8/Mono12
Signal Noise Ratio	39dB	41dB
Synchronization	Hardware trigger, software trigger	
I/O	1 opto-isolated input line and 1 opto-isolated output line, 2 GPIOs	
Operating Temp.	0°C~45°C	
Storage Temp.	-20°C~70°C	
Operating Humidity	10%~80%	
Camera Power Requirements	PoE (Power over Ethernet, 802.3af compliant) or +12 VDC (± 10%), supplied via the camera's 8-pin Hirose connector	
Power Consumption	<3W@12VDC, <3.75W@PoE	
Lens Mount	C	
Dimensions	38.3mm×29mm×29mm (without lens adapter or connectors)	

Weight	75g
Operating System	Windows XP / Win7 / Win8 / Win8.1 / Win10 / Windows Embedded 32bit and 64bit OS, Ubuntu14.04 / Ubuntu16.04 Linux OS
Data Interface	Fast Ethernet (100Mbit/s) or Gigabit Ethernet (1000Mbit/s)
Programmable Control	Image size, gain, Exposure time, trigger polarity, flash polarity
Conformity	CE, RoHS, FCC, GigE Vision, GenICam, IEEE802.3af, KCC

4.47.2. Spectral Response

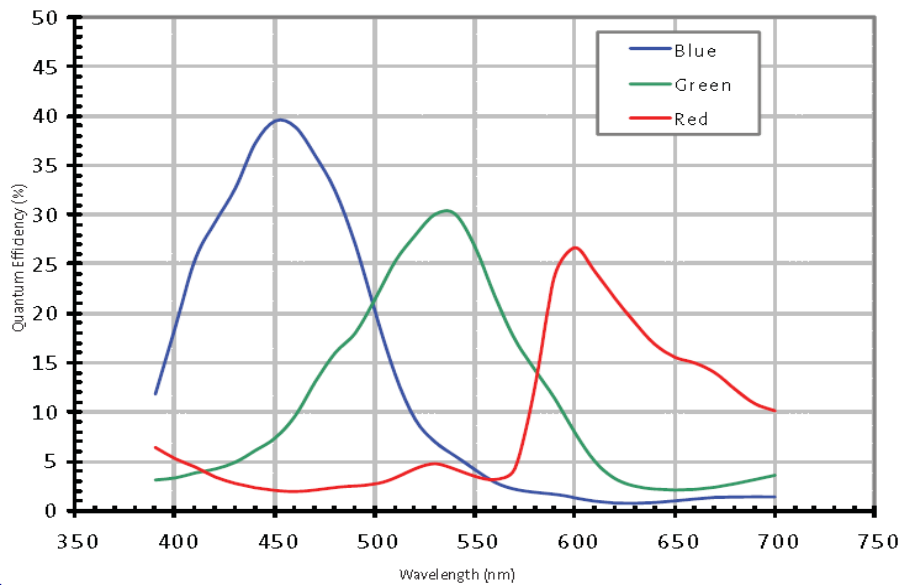

Figure 4-74 MER-1070-10GC-P sensor spectral response

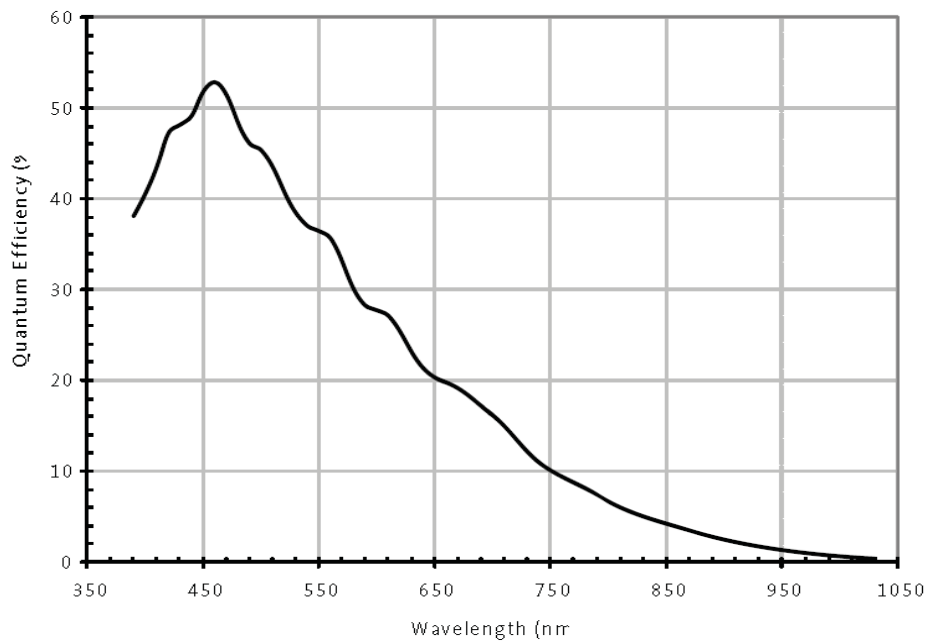

Figure 4-75 MER-1070-10GM-P sensor spectral response

4.48. MER-1220-9GC / MER-1220-9GM

4.48.1. Parameters

Specifications	MER-1220-9GC	MER-1220-9GM
Resolution	4024×3036	
Sensor Type	Sony IMX226 rolling shutter CMOS	
Max. Image Circle	1/1.7 inch	
Pixel Size	1.85μm×1.85μm	
Frame Rate	Default: 8.7fps@4024×3036 Higher frame rates (9fps) are possible if you change the Packet Size to 8192 and the Bandwidth Reserve to 5 Trigger Mode:7.5fps@4024×3036	
ADC Bit Depth	12bit	
Pixel Bit Depth	8bit, 12bit	
Shutter Time	23μs~1s	
Gain	0dB~24dB	
Pixel Formats	Bayer RG8/Bayer RG12	Mono8/Mono12
Signal Noise Ratio	44dB	40.73dB
Synchronization	Hardware trigger, software trigger	
I/O	1 opto-isolated input line and 1 opto-isolated output line, 2 GPIOs	
Operating Temp.	0°C~45°C	
Storage Temp.	-20°C~70°C	
Operating Humidity	10%~80%	
Power Consumption	<2W@12VDC	
Lens Mount	C	
Dimensions	29mm×29mm×29mm (without lens adapter or connectors)	

Weight	60g
Operating System	Windows XP / Win7 / Win8 / Win8.1 / Win10 / Windows Embedded 32bit and 64bit OS, Ubuntu14.04 / Ubuntu16.04 Linux OS
Data Interface	Fast Ethernet (100Mbit/s) or Gigabit Ethernet (1000Mbit/s)
Programmable Control	Image size, gain, Exposure time, trigger polarity, flash polarity
Conformity	CE, RoHS, FCC, GigE Vision, GenICam

4.48.2. Spectral Response

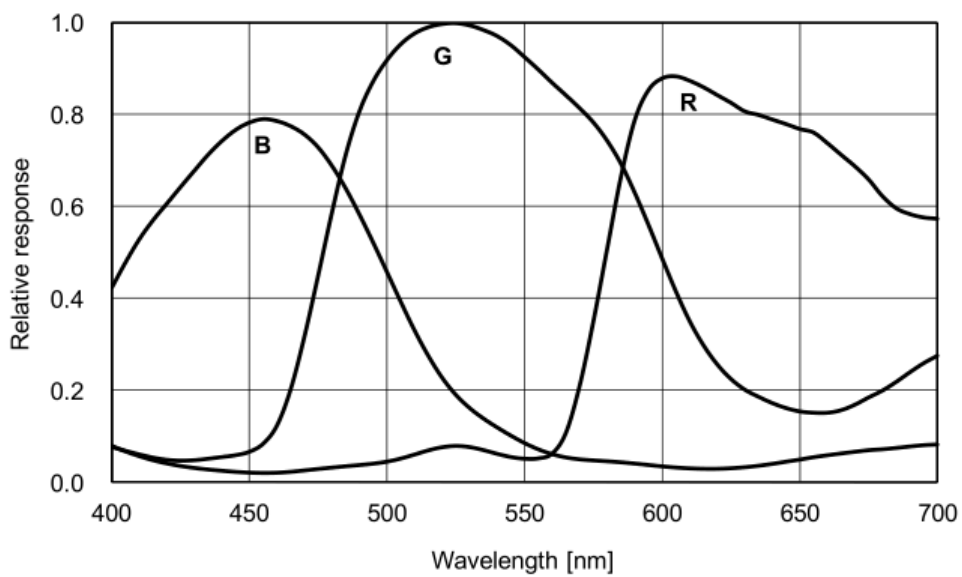

Figure 4-76 MER-1220-9GC sensor spectral response

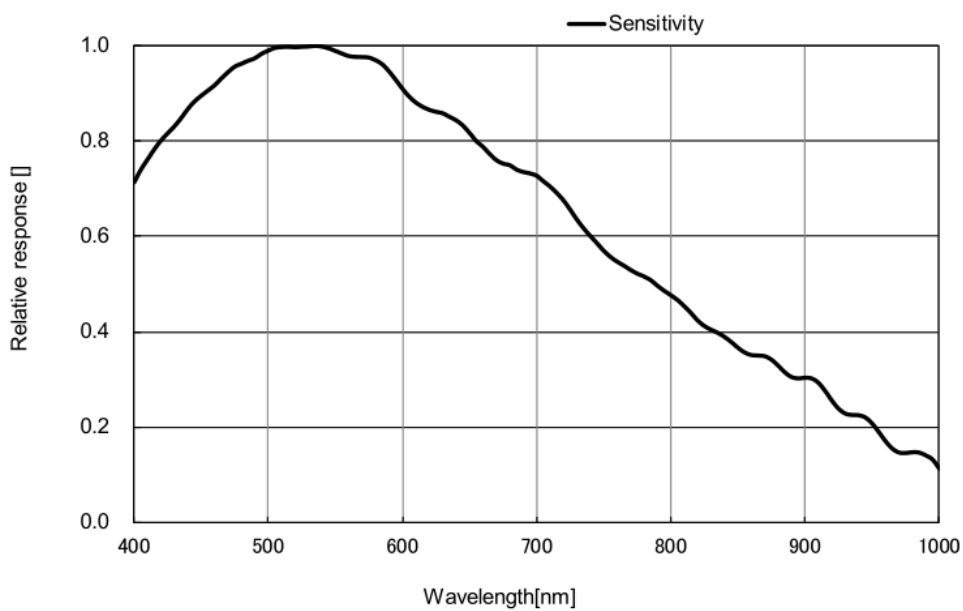

Figure 4-77 MER-1220-9GM sensor spectral response

4.49. MER-1220-9GC-P / MER-1220-9GM-P

4.49.1. Parameters

Specifications	MER-1220-9GC-P	MER-1220-9GM-P
Resolution	4024x3036	
Sensor Type	Sony IMX226 rolling shutter CMOS	
Max. Image Circle	1/1.7 inch	
Pixel Size	1.85μm×1.85μm	
Frame Rate	Default: 8.7fps@4024x3036 Higher frame rates (9fps) are possible if you change the Packet Size to 8192 and the Bandwidth Reserve to 5 Trigger Mode:7.5fps@4024x3036	
ADC Bit Depth	12bit	
Pixel Bit Depth	8bit, 12bit	
Shutter Time	23μs~1s	
Gain	0dB~24dB	
Pixel Formats	Bayer RG8/Bayer RG12	Mono8/Mono12
Signal Noise Ratio	40.71dB	40.81dB
Synchronization	Hardware trigger, software trigger	
I/O	1 opto-isolated input line and 1 opto-isolated output line, 2 GPIOs	
Operating Temp.	0°C~45°C	
Storage Temp.	-20°C~70°C	
Operating Humidity	10%~80%	
Camera Power Requirements	PoE (Power over Ethernet, 802.3af compliant) or +12 VDC (± 10%), supplied via the camera's 8-pin Hirose connector	
Power Consumption	<3W@12VDC, <3.75W@PoE	
Lens Mount	C	

Dimensions	38.3mm×29mm×29 mm (without lens adapter or connectors)
Weight	75g
Operating System	Windows XP / Win7 / Win8 / Win8.1 / Win10 / Windows Embedded 32bit and 64bit OS, Ubuntu14.04 / Ubuntu16.04 Linux OS
Data Interface	Fast Ethernet (100Mbit/s) or Gigabit Ethernet (1000Mbit/s)
Programmable Control	Image size, gain, Exposure time, trigger polarity, flash polarity
Conformity	CE, RoHS, FCC, GigE Vision, GenICam, IEEE802.3af

4.49.2. Spectral Response

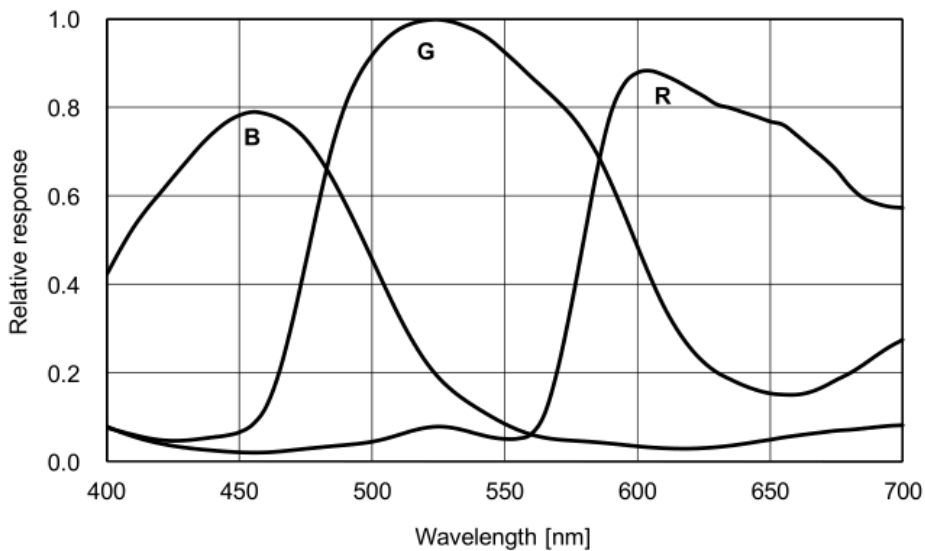

Figure 4-78 MER-1220-9GC-P sensor spectral response

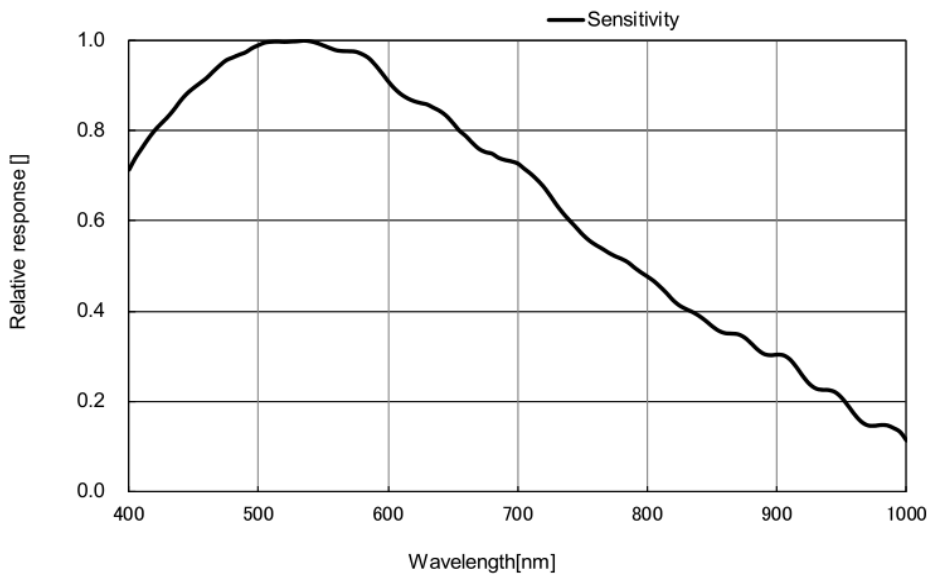

Figure 4-79 MER-1220-9GM-P sensor spectral response

4.50. MER-1520-7GC

4.50.1. Parameters

Specifications	MER-1520-7GC
Resolution	4608×3288
Sensor Type	MT9F002 electronic rolling shutter CMOS
Max. Image Circle	1/2.3 inch
Pixel Size	1.4μm×1.4μm
Frame Rate	7fps@4608×3288
ADC Bit Depth	12bit
Pixel Bit Depth	8bit, 12bit
Shutter Time	42μs~1s
Gain	0dB~22.5dB
Pixel Formats	Bayer GR8/Bayer GR12
Signal Noise Ratio	38dB
Synchronization	Hardware trigger, software trigger
I/O	1 opto-isolated input line and 1 opto-isolated output line, 2 GPIOs
Operating Temp.	0°C~45°C
Storage Temp.	-20°C~70°C
Operating Humidity	10%~80%
Power Consumption	<3W@12V
Lens Mount	C
Dimensions	29mm×29mm×29mm (without lens adapter or connectors)
Weight	60g
Operating System	Windows XP / Win7 / Win8 / Win8.1 / Win10 / Windows Embedded 32bit and 64bit OS, Ubuntu14.04 / Ubuntu16.04 Linux OS
Data Interface	Fast Ethernet (100Mbit/s) or Gigabit Ethernet (1000Mbit/s)

Programmable Control	Image size, gain, Exposure time, trigger polarity, flash polarity
Conformity	CE, RoHS, FCC, GigE Vision, GenICam

4.50.2. Spectral Response

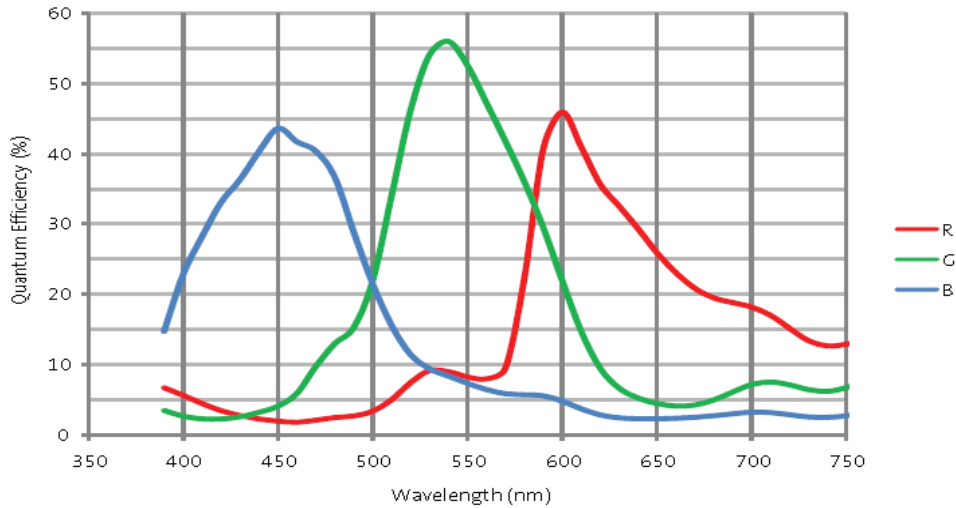

Figure 4-80 MER-1520-7GC sensor spectral response

4.51. MER-1520-7GC-P

4.51.1. Parameters

Specifications	MER-1520-7GC-P
Resolution	4608×3288
Sensor Type	MT9F002 electronic rolling shutter CMOS
Max. Image Circle	1/2.3 inch
Pixel Size	1.4μm×1.4μm
Frame Rate	7fps@4608×3288
ADC Bit Depth	12bit
Pixel Bit Depth	8bit, 12bit
Shutter Time	42μs~1s
Gain	0dB~22.5dB
Pixel Formats	Bayer GR8/Bayer GR12

Signal Noise Ratio	35.11dB
Synchronization	Hardware trigger, software trigger
I/O	1 opto-isolated input line and 1 opto-isolated output line, 2 GPIOs
Operating Temp.	0°C~45°C
Storage Temp.	-20°C~70°C
Operating Humidity	10%~80%
Camera Power Requirements	PoE (Power over Ethernet, 802.3af compliant) or +12 VDC (± 10%), supplied via the camera's 8-pin Hirose connector
Power Consumption	<3W@12VDC, <3.75W@PoE
Lens Mount	C
Dimensions	38.3mm×29mm×29mm (without lens adapter or connectors)
Weight	75g
Operating System	Windows XP / Win7 / Win8 / Win8.1 / Win10 / Windows Embedded 32bit and 64bit OS, Ubuntu14.04 / Ubuntu16.04 Linux OS
Data Interface	Fast Ethernet (100Mbit/s) or Gigabit Ethernet (1000Mbit/s)
Programmable Control	Image size, gain, Exposure time, trigger polarity, flash polarity
Conformity	CE, RoHS, FCC, GigE Vision, GenICam, IEEE802.3af

4.51.2. Spectral Response

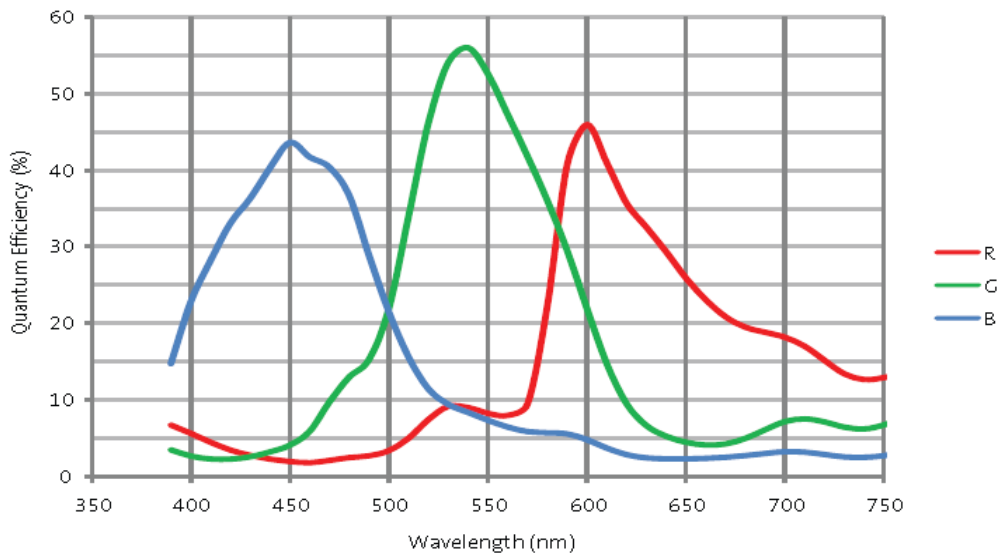

Figure 4-81 MER-1520-7GC-P sensor spectral response

4.52. MER-2000-5GC / MER-2000-5GM

4.52.1. Parameters

Specifications	MER-2000-5GC	MER-2000-5GM
Resolution	5496x3672	
Sensor Type	Sony IMX183 rolling shutter CMOS	
Max. Image Circle	1 inch	
Pixel Size	2.4 μ m \times 2.4 μ m	
Frame Rate	5fps@5496x3672	
ADC Bit Depth	12bit	
Pixel Bit Depth	8bit, 12bit	
Shutter Time	31 μ s~1s	
Gain	0dB~24dB	
Pixel Formats	Bayer RG8/Bayer RG12	Mono8/Mono12
Signal Noise Ratio	45dB	41.16dB
Synchronization	Hardware trigger, software trigger	
I/O	1 opto-isolated input line and 1 opto-isolated output line, 2 GPIOs	
Operating Temp.	0°C~45°C	
Storage Temp.	-20°C~70°C	
Operating Humidity	10%~80%	
Power Consumption	<2W@12VDC	
Lens Mount	C	
Dimensions	29mm \times 29mm \times 29mm (without lens adapter or connectors)	
Weight	60g	

Operating System	Windows XP / Win7 / Win8 / Win8.1 / Win10 / Windows Embedded 32bit and 64bit OS, Ubuntu14.04 / Ubuntu16.04 Linux OS
Data Interface	Fast Ethernet (100Mbit/s) or Gigabit Ethernet (1000Mbit/s)
Programmable Control	Image size, gain, Exposure time, trigger polarity, flash polarity
Conformity	CE, RoHS, FCC, GigE Vision, GenICam

4.52.2. Spectral Response

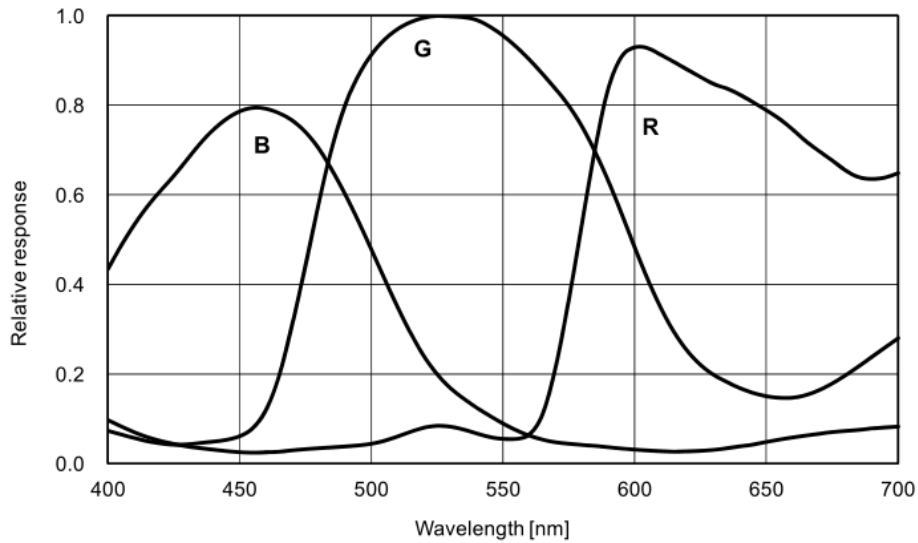

Figure 4-82 MER-2000-5GC sensor spectral response

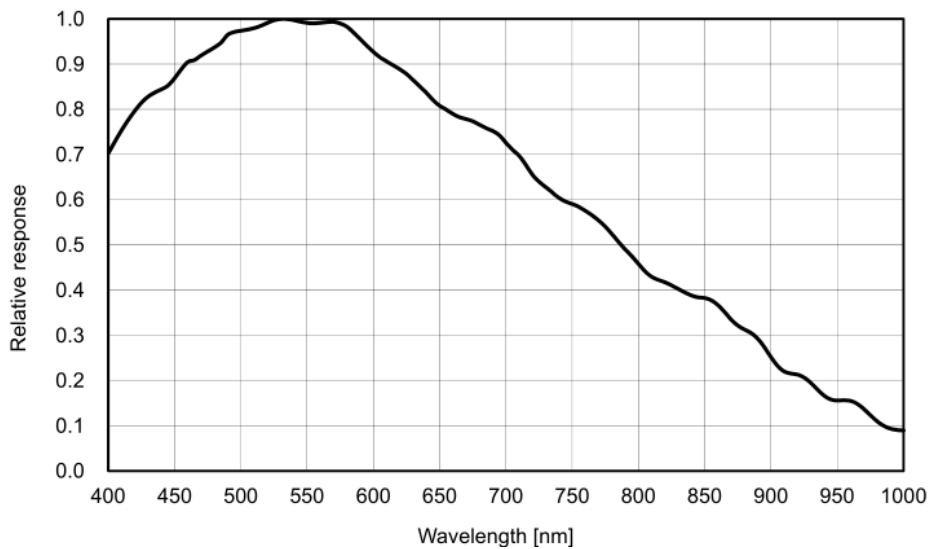

Figure 4-83 MER-2000-5GM sensor spectral response

4.53. MER-2000-5GC-P / MER-2000-5GM-P

4.53.1. Parameters

Specifications	MER-2000-5GC-P	MER-2000-5GM-P
Resolution	5496x3672	
Sensor Type	Sony IMX183 rolling shutter CMOS	
Max. Image Circle	1 inch	
Pixel Size	2.4 μ m \times 2.4 μ m	
Frame Rate	5fps@5496x3672	
ADC Bit Depth	12bit	
Pixel Bit Depth	8bit, 12bit	
Shutter Time	31 μ s~1s	
Gain	0dB~24dB	
Pixel Formats	Bayer RG8/Bayer RG12	Mono8/Mono12
Signal Noise Ratio	45dB	41.16dB
Synchronization	Hardware trigger, software trigger	
I/O	1 opto-isolated input line and 1 opto-isolated output line, 2 GPIOs	
Operating Temp.	0°C~45°C	
Storage Temp.	-20°C~70°C	
Operating Humidity	10%~80%	
Camera Power Requirements	PoE (Power over Ethernet, 802.3af compliant) or +12 VDC (\pm 10%), supplied via the camera's 8-pin Hirose connector	
Power Consumption	<3W@12VDC, <3.75W@PoE	
Lens Mount	C	
Dimensions	38.3mm \times 29mm \times 29mm (without lens adapter or connectors)	

Weight	75g
Operating System	Windows XP / Win7 / Win8 / Win8.1 / Win10 / Windows Embedded 32bit and 64bit OS, Ubuntu14.04 / Ubuntu16.04 Linux OS
Data Interface	Fast Ethernet (100Mbit/s) or Gigabit Ethernet (1000Mbit/s)
Programmable Control	Image size, gain, Exposure time, trigger polarity, flash polarity
Conformity	CE, RoHS, FCC, GigE Vision, GenICam, IEEE802.3af

4.53.2. Spectral Response

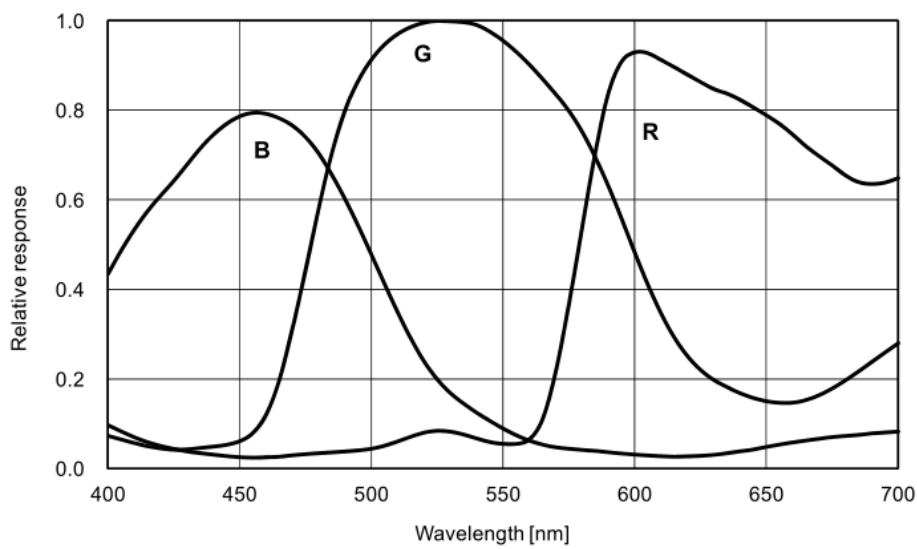

Figure 4-84 MER-2000-5GC-P sensor spectral response

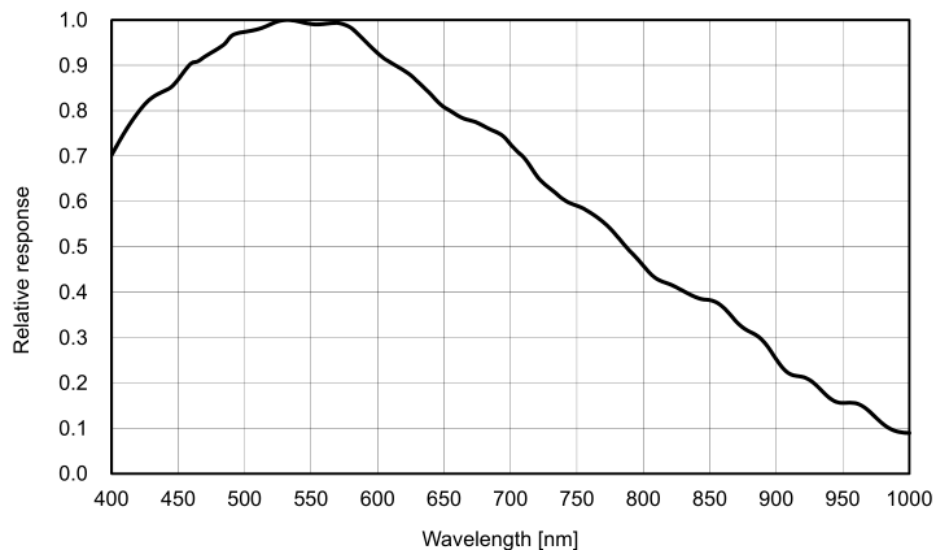

Figure 4-85 MER-2000-5GM-P sensor spectral response

5. Dimensions

5.1. Camera Dimensions

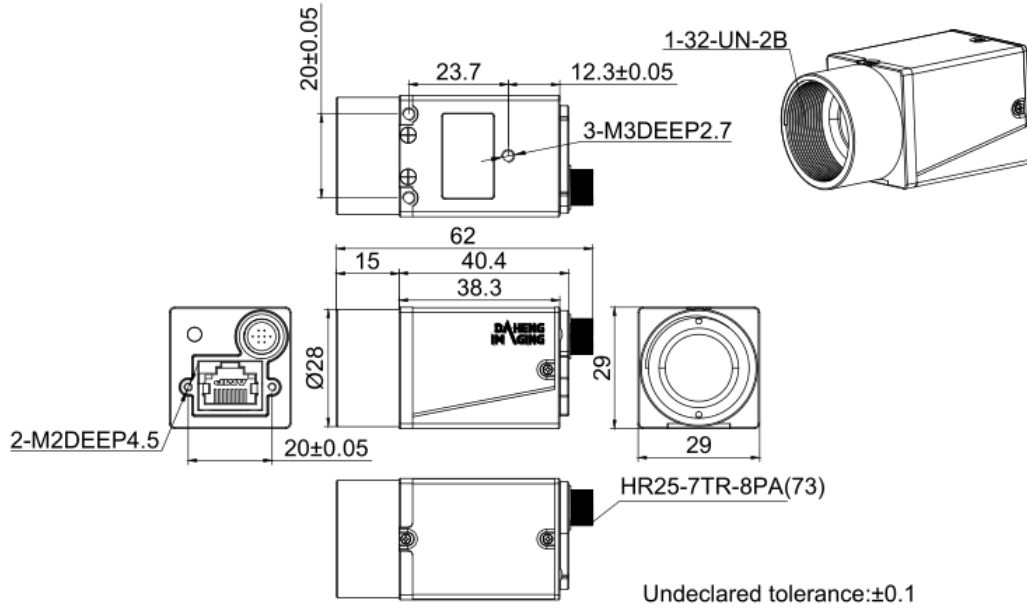

Figure 5-1 MER-G-P mechanical dimensions

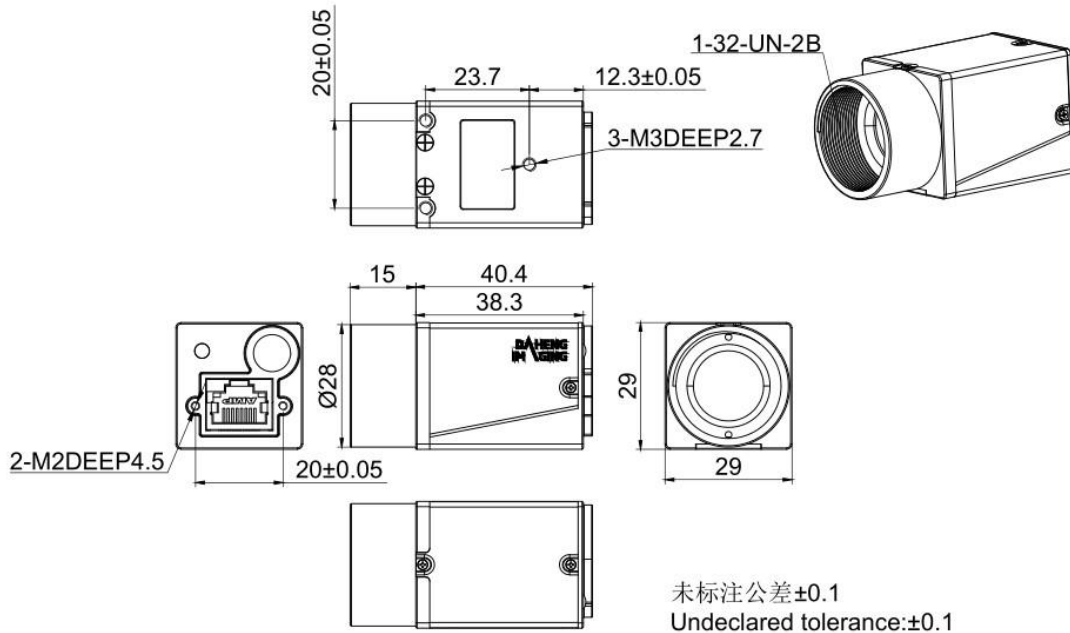

Figure 5-2 MER-203-30GC-P-L, MER-203-30GC-P-L-F03, MER-204-30GC-P-L-F02 mechanical dimensions

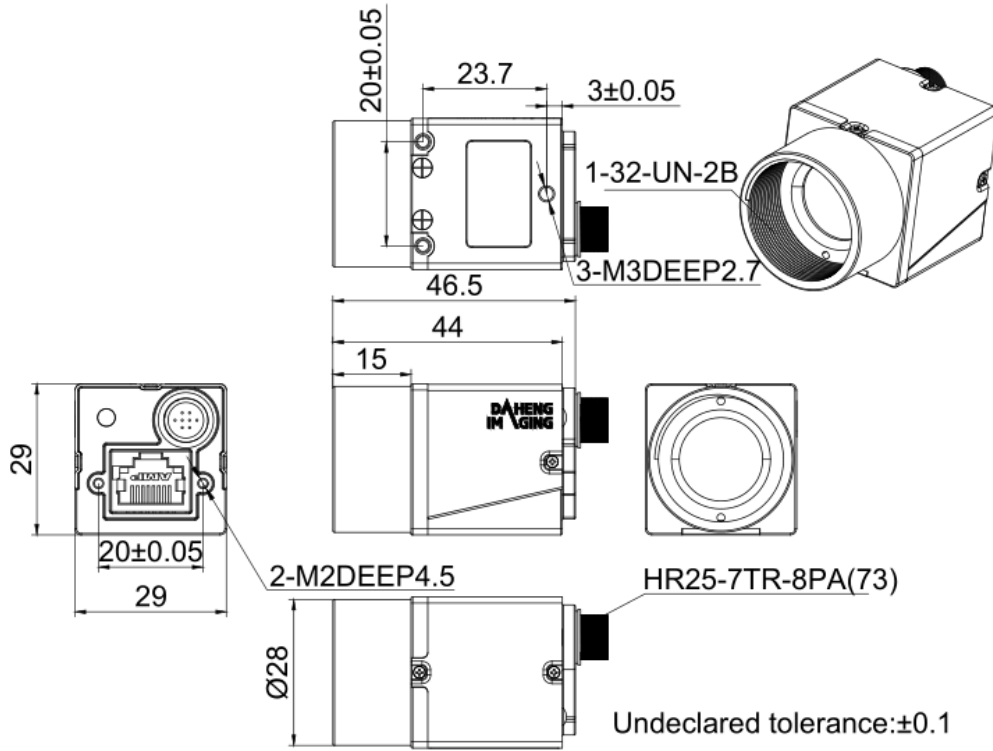

Figure 5-3 MER-G mechanical dimensions

5.2. Optical Interface

MER-G and MER-G-P cameras have the same max. image circle.

The cameras are equipped with C-mount lens adapters. The back-flange distance is 17.526 mm (in the air). The maximum allowed thread length of lens should be less than 11.3mm, as shown in Figure 5-4.

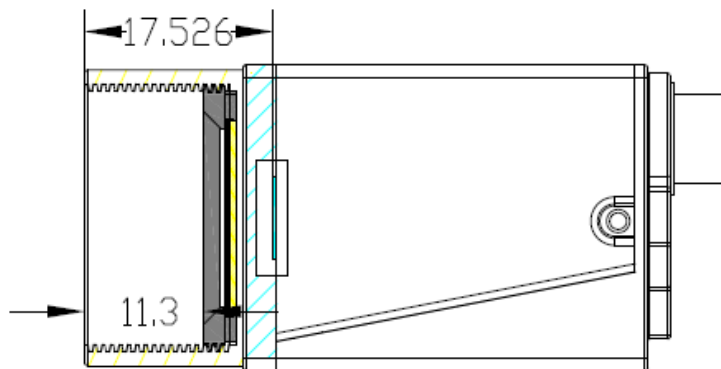

Figure 5-4 Optical interface of C-mount

5.3. Tripod Adapter Dimensions

When customizing the tripod adapter, you need to consider the relationship between tripod adapter, screw length and step thickness of tripod adapter.

- 1) Screw length = tripod adapter step thickness + spring washer thickness + screwing length of camera screw thread.

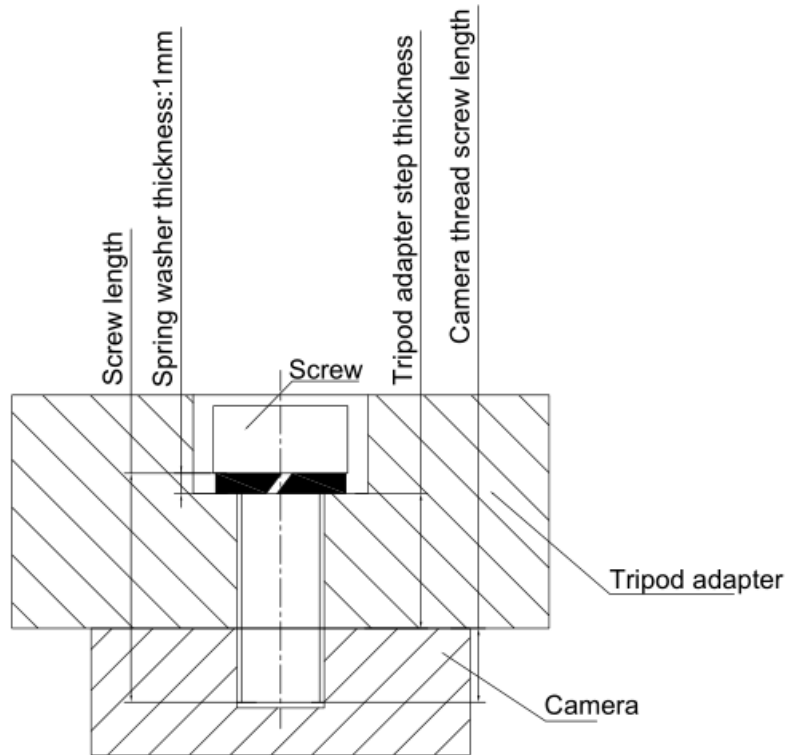

Figure 5-5 Schematic diagram of screw specification, tripod adapter step thickness and spring washer thickness

- 2) It is recommended that you select the screw specifications and the tripod adapter step thickness from the table below:

Screw specification	Tripod adapter step thickness (mm)	Spring washer thickness (mm)	Screwing length of camera screw thread (mm)
M3*6 screw	2.3	1	2.7
M3*8 screw	4.3	1	2.7
M3*10 screw	6.3	1	2.7



If the screw specification and the thickness of the tripod adapter do not conform to the requirement above, it may cause the camera thread hole through or thread stripping.

6. Filters and Lenses

6.1. Filters

The MERCURY color models are equipped with IR filters. The thickness of the filter is $0.7\pm 0.05\text{mm}$, and it can filter out light waves above 700nm, which reduces the influence of invisible light on the image. The monochrome models are equipped with transparent glasses. Remove IR-filters or transparent glasses will defocus the image plane. The MER-203-30GC-P-L-F03 model are equipped with band-pass (BP) filters. The thickness of the filter is $0.5\pm 0.05\text{mm}$, and it can pass light waves between 820~860nm.

Contact our technical support when the glass needed to be removed.

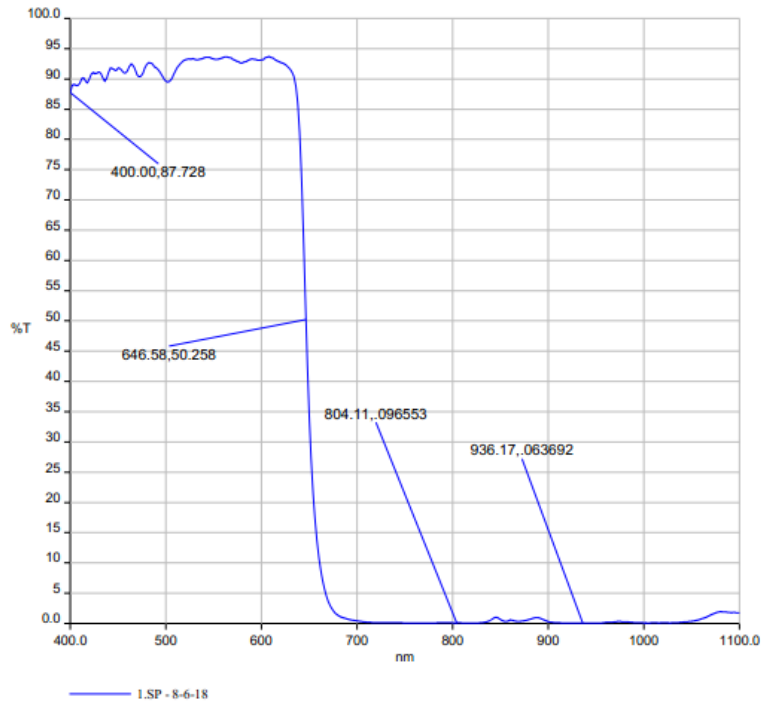

Figure 6-1 Infrared cut-off filter transmittance curve for MERCURY series color camera

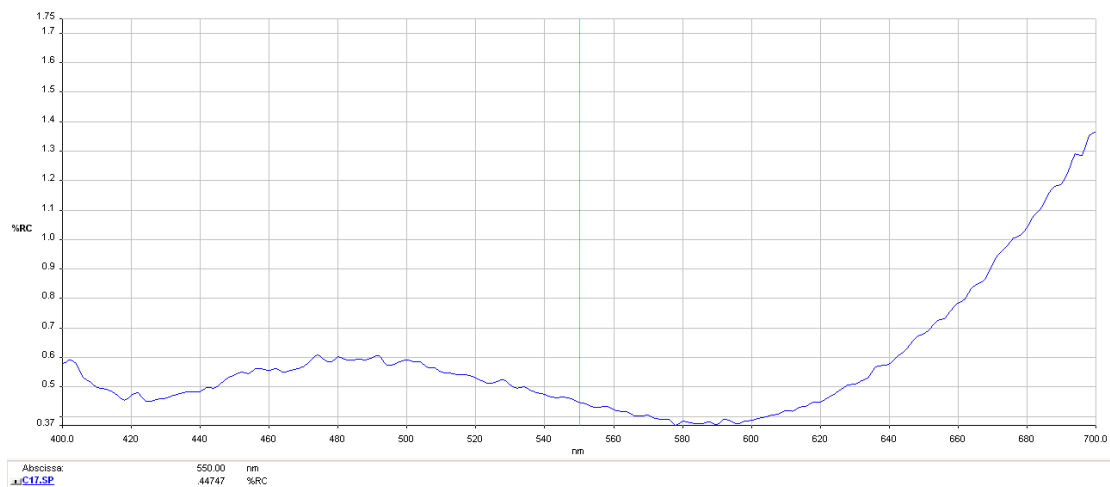

Figure 6-2 Transparent glass reflectance curve for MERCURY series mono camera

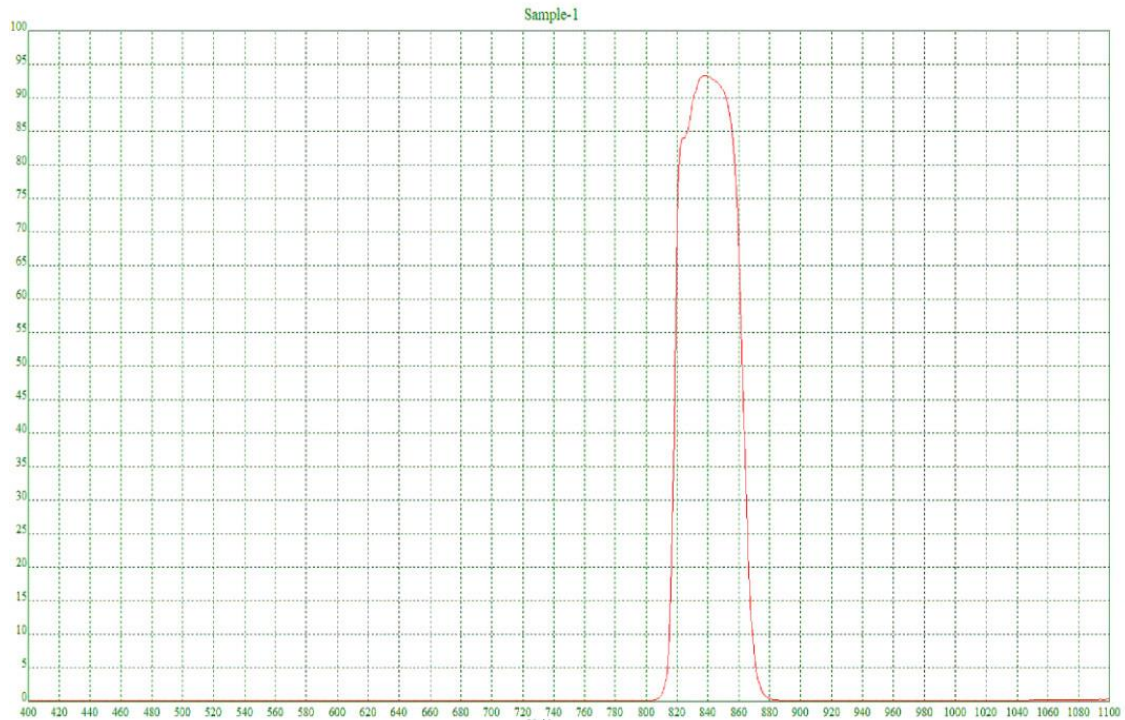

Figure 6-3 Visible light cut-off filter transmittance curve for MER-203-30GC-P-L-F03

6.2. Lens Selection Reference

DAHENG IMAGING is a professional supplier for images and machine vision devices in China. In addition to industrial cameras, it also provides high-resolution, high-optical machine vision lenses for a wide range of industrial cameras on the market.

In order to meet the requirements of machine vision for high resolution and low distortion, DAHENG IMAGING released seven series of industrial lenses, resolution from 2 megapixels to 25 megapixels, with small size, light weight, high resolution and low distortion rate, etc.

When choosing a lens, there are several factors to consider:

1) Lens mount

- According to the connection methods of the lens and the camera, the commonly used mounts are C, CS, F, V, Leica, M42, M58, M72, M90, and so on
- The MERCURY series GigE digital camera is equipped with a standard C-Mount. When selecting a lens, select the lens of the same mount as the camera

2) Max. Image Circle

- The maximum sensor size that the lens image can cover. There are mainly 1/2", 2/3", 1/1.2", 1", 1.1", 4/3", and so on
- When selecting a lens, make sure that the max. image circle of the lens is not smaller than the sensor size of the digital camera

3) Resolution

- The resolution represents the ability of the lens to record the details of the object, usually in units of line pairs that can be resolved per millimeter: line pair/mm (lp/mm). The higher the resolution of the lens, the sharper the image
- When selecting a lens, make sure that the accuracy required by the system is less than the resolution of the lens

4) Working distance

- The distance from the first working surface of the lens to the object being inspected
- When selecting a lens, make sure that the working distance is larger than the lens parameter "minimum object distance"

5) Focal length

- The focal length is the distance from the center point of the lens to the clear image formed on the focal plane. The smaller the focal length value, the larger the field of view of the digital camera
- For focal length calculation, we need to confirm three parameters: the field of view, the sensor size of the digital camera and the working distance. The focal length (f) of the expected lens can be calculated by the following formula

$f = \text{sensor size (horizontal or vertical)} * \text{Working distance} / \text{Field of View (corresponding to the horizontal or vertical direction of the sensor size)}$

The corresponding lens is selected by the calculated focal length.

6.2.1. HN-2M Series

The HN-2M series lenses are 2 megapixels lenses for industrial, suitable for sensors with max. image circle of 1/2" ~ 2/3". This series of lenses has the following features:

- High optical performance with optical design supporting up to 2/3" sensor size, 6.2 μ m pixel size (up to 2 megapixels) sensor. 8 models with F values below 2.8, clear images can be obtained even in low light environment
- Excellent anti-shock and anti-vibration performance, with a unique mechanical structure, the optical axis fluctuates below 10 μ m
- The housing is small and compact, the minimum outer diameter is only ϕ 29.5mm, and it can be installed in various limited spaces
- Easy to install, there are 3 fixing holes on the lens barrel for fixing the iris and focusing. The best fixing hole can be selected according to the installation environment

Models:

- HN-0612-2M-C1/2X

- HN-0914-2M-C2/3X
- HN-12.514-2M-C2/3X
- HN-1614-2M-C2/3X
- HN-2514-2M-C2/3X
- HN-3516-2M-C2/3X
- HN-5023-2M-C2/3X
- HN-7528-2M-C2/3X

6.2.2. HN-5M Series

The HN-5M series lenses are 5 megapixels lenses for industrial, suitable for sensors with max. image circle of 2/3" ~ 1.1". This series of lenses has the following features:

- 5 megapixels resolution, the definition is consistent from the center to the periphery, greatly improving the distance between iris and photography
- The housing is small and compact, the minimum outer diameter is only $\phi 29.5\text{mm}$, and it can be installed in various limited spaces
- Easy to install, there are 3 fixing holes on the lens barrel for fixing the iris and focusing. The best fixing hole can be selected according to the installation environment

Models:

- HN-0619-5M-C2/3X
- HN-0816-5M-C2/3X
- HN-1216-5M-C2/3X
- HN-1616-5M-C2/3X
- HN-2516-5M-C2/3X
- HN-3519-5M-C2/3X
- HN-5024-5M-C2/3X

6.2.3. HN-6M Series

The HN-6M series lenses are 6 megapixels lenses for industrial, suitable for sensors with max. image circle of 2/3". This series of lenses has the following features:

- 6 megapixels resolution, 5~75mm focal length available
- Stable performance at long working distance

- Compact and robust
- Up to 5G of anti-vibration performance

Models:

- HN-0528-6M-C2/3B
- HN-0828-6M-C2/3B
- HN-1228-6M-C2/3B
- HN-1628-6M-C2/3B
- HN-2528-6M-C2/3B
- HN-3528-6M-C2/3B
- HN-5028-6M-C2/3B
- HN-7528-6M-C2/3B

6.2.4. HN-20M Series

The HN-20M series lenses are 20 megapixels lenses for industrial, suitable for sensors with max. image circle of 1". This series of lenses has the following features:

- 20 megapixels resolution, 8~75mm focal length available
- Ultra-low optical distortion and excellent uniformity of brightness
- Stable performance at different working distance by floating design
- The housing is small and compact, up to 5G of anti-vibration performance
- the definition is consistent from the center to the periphery, greatly improving the distance between iris and photography

Models:

- HN-0826-20M-C1/1X
- HN-1226-20M-C1/1X
- HN-1624-20M-C1/1X
- HN-2520-20M-C1/1X
- HN-3522-20M-C1/1X
- HN-5024-20M-C1/1X
- HN-7531-20M-C1/1X

6.2.5. HN-P-6M Series

The HN-P-6M series lenses are 6 megapixels lenses for industrial, suitable for sensors with max. image circle of 1/1.8" ~ 2/3". This series of lenses has the following features:

- 6 megapixels resolution, 6~50mm focal length available
- The housing is small and compact, the minimum outer diameter is only $\phi 33.0\text{mm}$, and it can be installed in various limited spaces
- Ultra-low optical distortion, greatly improving the accuracy and stability

Models:

- HN-P-0628-6M-C1/1.8
- HN-P-0828-6M-C2/3
- HN-P-1228-6M-C2/3
- HN-P-1628-6M-C2/3
- HN-P-2528-6M-C2/3
- HN-P-3528-6M-C2/3
- HN-P-5028-6M-C2/3

6.2.6. HN-P-10M Series

The HN-P-10M series lenses are 10 megapixels lenses for industrial, suitable for sensors with max. image circle of 2/3". This series of lenses has the following features:

- 10 megapixels resolution, 8~50mm focal length available
- 2.4 μm small pixel size, F1.8 large aperture design
- The housing is small and compact, the minimum outer diameter is only $\phi 32.0\text{mm}$, and it can be installed in various limited spaces
- Ultra-low optical distortion

Models:

- HN-P-0824-10M-C2/3
- HN-P-1220-10M-C2/3
- HN-P-1618-10M-C2/3
- HN-P-2518-10M-C2/3
- HN-P-3520-10M-C2/3

- HN-P-5028-10M-C2/3

6.2.7. HN-P-25M Series

The HN-P-25M series lenses are 25 megapixels lenses for industrial, suitable for sensors with max. image circle of 1.2". This series of lenses has the following features:

- 25 megapixels resolution, 12~50mm focal length available
- 2.74 μ m small pixel size, F2.4 large aperture design
- Small and compact
- Ultra-low optical distortion

Models:

- HN-P-1224-25M-C1.2/1
- HN-P-1624-25M-C1.2/1
- HN-P-2524-25M-C1.2/1
- HN-P-3524-25M-C1.2/1
- HN-P-5024-25M-C1.2/1

7. Electrical Interface

7.1. LED Light

An LED light is set on the back cover of camera which indicates camera's status, as shown in Table 7-1. LED light can display 3 colors: red, yellow and green.

LED status	Camera status
Off	No power
Solid red	The camera is powered on, but the program does not start properly
Solid green	Ethernet is connected, but no data is being transmitted
Solid yellow	The camera starts properly, but the network connection is not established
Flashing yellow	The camera's permanent IP address and other real-time save parameters are incorrect or the camera is started in the userset mode, the parameter set is wrong, and the camera is switched to the default mode to start. Use the IP Configurator to save the camera IP or re-save the userset. After the camera is powered on, the LED status returns to green
Flashing green	Data is being transmitted through Ethernet
Flashing red-green	Camera initialization failed

Table 7-1 Camera status

7.2. Ethernet Port

Ethernet connector is a standard RJ45 jack, and the pin definition follows the Ethernet standard.

Ethernet port supports CAT-5e cables or above, and the cable length can be up to 100m.

Power can be supplied to the MER-G-P camera via Power over Ethernet (IEEE802.3af compatible), i.e., via the Ethernet cable plugged into the camera's RJ45 jack.

7.3. I/O Port

I/O port is implemented by 8-pin Hirose connector (No. HR25-7TR-8PA(73)), and the corresponding plug is HR25-7TP-8S.

Diagram	Pin	Definition	Core Color	Description
	1	Line0+	green	Opto-isolated input +
	2	GND	blue	PWR GND & GPIO GND
	3	Line0-	grey	Opto-isolated input -
	4	POWER_IN	purple	Camera external power (+12V DC)
	5	Line2	orange	GPIO input/output
	6	Line3	pink	GPIO input/output
	7	Line1-	white green	Opto-isolated output -
	8	Line1+	white blue	Opto-isolated output +

Table 7-2 I/O port definition (back sight of camera)

The input power of MER-G-P/MER-G series digital camera must be +12V ($\pm 10\%$) when powered by I/O port.



The polarity of power cannot be reversed, otherwise, camera or other peripherals could burn out.

7.3.1. Line0 (Opto-isolated Input) Circuit

Hardware schematics of opto-isolated input circuit is shown as Figure 7-1.

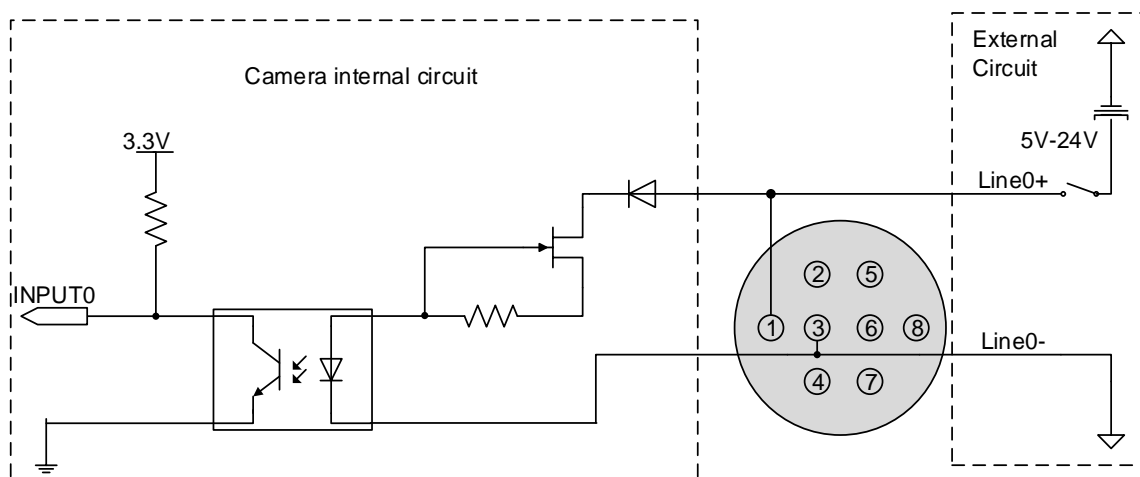

Figure 7-1 Opto-isolated input circuit

- Logic 0 input voltage: 0V~+2.5V (Line0+ voltage)
- Logic 1 input voltage: +5V~+24V (Line0+ voltage)

- Minimum input current: 7mA
- The status is unstable when input voltage is between 2.5V and 5V, which should be avoided
- When peak voltage of input signal over 9V, a current limiting resistor is recommended to protect the input line. The recommended resistance is shown in Table 7-3

External input voltage	Circuit-limiting resistance R _{limit}	Line0+ input voltage
9V	680Ω	About 5.5V
12V	1kΩ	About 6V
24V	2kΩ	About 10V

Table 7-3 Circuit-limiting resistor value

The connection method of the opto-isolated input circuit and the NPN and PNP photosensor is shown in Figure 7-2 and Figure 7-3. The relationship between the pull-up resistor value and the external power supply voltage is shown in Table 7-3.

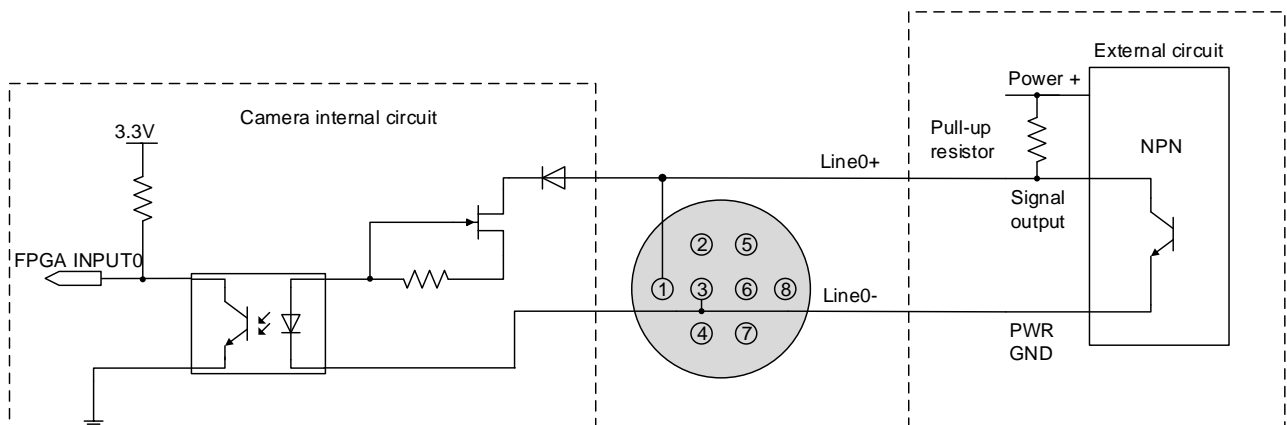

Figure 7-2 NPN photosensor connected to opto-isolated input circuit

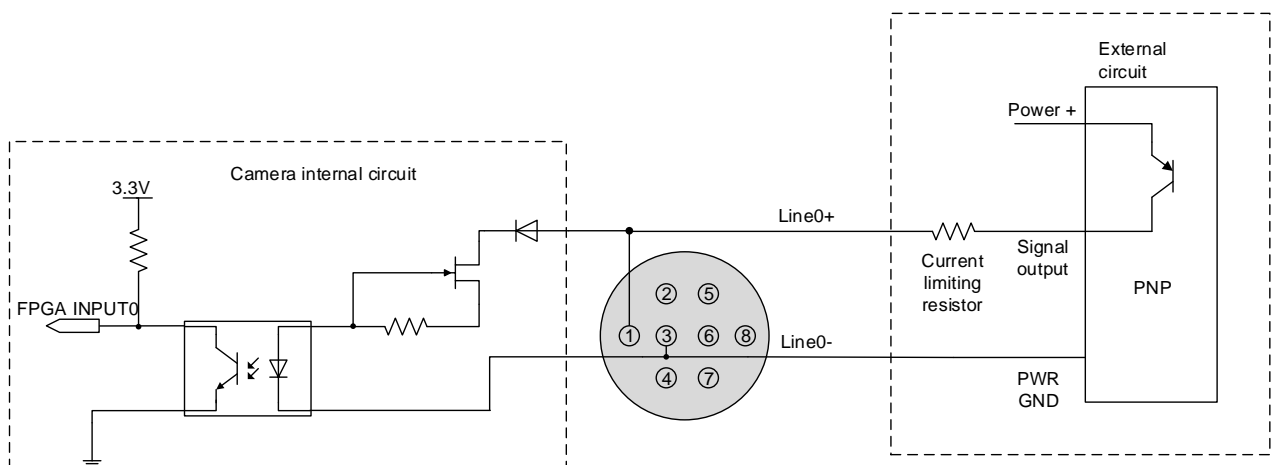

Figure 7-3 PNP photosensor connected to opto-isolated input circuit

- Rising edge delay: <math><50\mu\text{s}</math> (0°C~45°C), parameter description as shown in Figure 7-4

- Falling edge delay: $<50\mu\text{s}$ ($0^\circ\text{C}\sim 45^\circ\text{C}$), parameter description as shown in Figure 7-4
- Different environment temperature and input voltage have influence on delay time of opto-isolated input circuit. Delay time in typical application environment (temperature is 25°C) is as shown in Table 7-4

Parameter	Test condition	Value (μs)		
Rising edge delay	VIN=5V	3.02	~	6.96
	VIN=12V	2.46	~	5.14
Falling edge delay	VIN=5V	6.12	~	17.71
	VIN=12V	8.93	~	19.73

Table 7-4 Delay time of opto-isolated input circuit in typical application environment

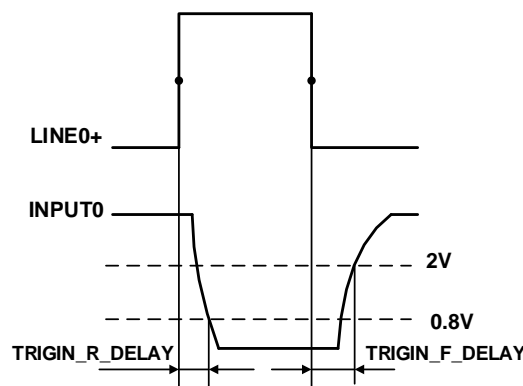

Figure 7-4 Parameter of opto-isolated input circuit

- Rising time delay (TRIGIN_R_DELAY): the response time from LINE0+ rises to 50% of amplitude to INPUT0 decreases to 0.8V
- Falling time delay (TRIGIN_F_DELAY): the response time from LINE0+ decreases to 50% of amplitude to INPUT0 rises to 2V

7.3.2. Line1 (Opto-isolated Output) Circuit

Hardware schematics of opto-isolated output circuit is shown as Figure 7-5.

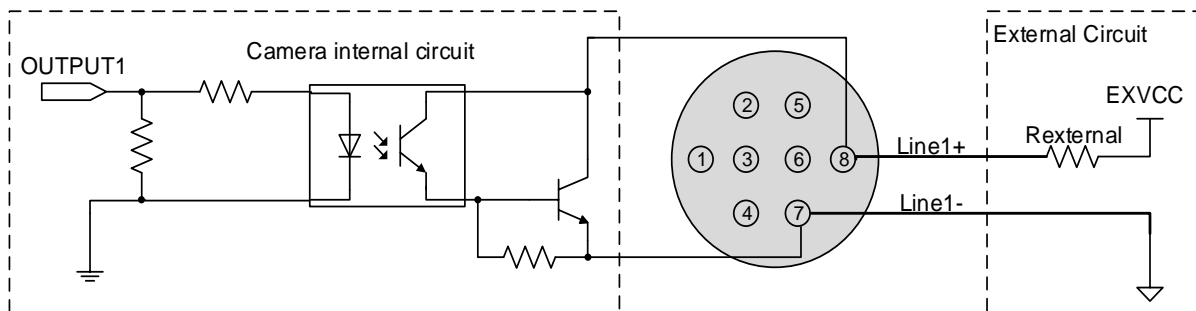

Figure 7-5 Opto-isolated output circuit

- Range of external voltage (EXVCC) is 5~24V
- Maximum output current of Line1 is 25mA

- Output voltage and output current of opto-isolated output circuit in typical application environment (temperature is 25°C) is as shown in Table 7-5

External voltage EXVCC	External resistance Rexternal	Output voltage (V)	Output current (mA)
5V	1kΩ	0.90	4.16
12V	1kΩ	0.97	11.11
24V	1kΩ	1.04	23.08

Table 7-5 Output voltage and output current of opto-isolated output circuit in typical application environment

- Rising time delay = t_r+t_d : $<50\mu s$ ($0^\circ C\sim 45^\circ C$) (parameter description is shown in Figure 7-6)
- Falling time delay = t_s+t_f : $<50\mu s$ ($0^\circ C\sim 45^\circ C$) (parameter description is shown in Figure 7-6)
- Delay time in typical application conditions (environment temperature is 25°C) are shown in Table 7-6

Parameter	Test Condition	Value (μs)		
Storage time (t_s)	External power is 5V, pull-up resistor is 1kΩ	6.16	~	13.26
Delay time (t_d)		1.90	~	3.16
Rising time (t_r)		2.77	~	10.60
Falling time (t_f)		7.60	~	11.12
Rising time delay = t_r+t_d		4.70	~	13.76
Falling time delay = t_f+t_s		14.41	~	24.38

Table 7-6 Delay time of opto-isolated output circuit in typical application environment

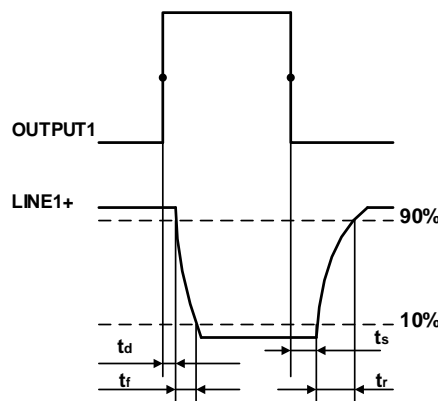

Figure 7-6 Parameter of opto-isolated output circuit

- Delay time (t_d): the response time from OUTPUT1 rises to 50% of amplitude to LINE1+ decreases to 90% of amplitude
- Falling time (t_f): the response time for LINE1+ to decrease from 90% of the amplitude to 10%

- Storage time (ts): the response time from OUTPUT1 decreases to 50% of amplitude to LINE1+ rises to 10% of amplitude
- Rising time (tr): the response time for LINE1+ to rise from 10% of the amplitude to 90%

7.3.3. GPIO 2/3 (Bidirectional) Circuit

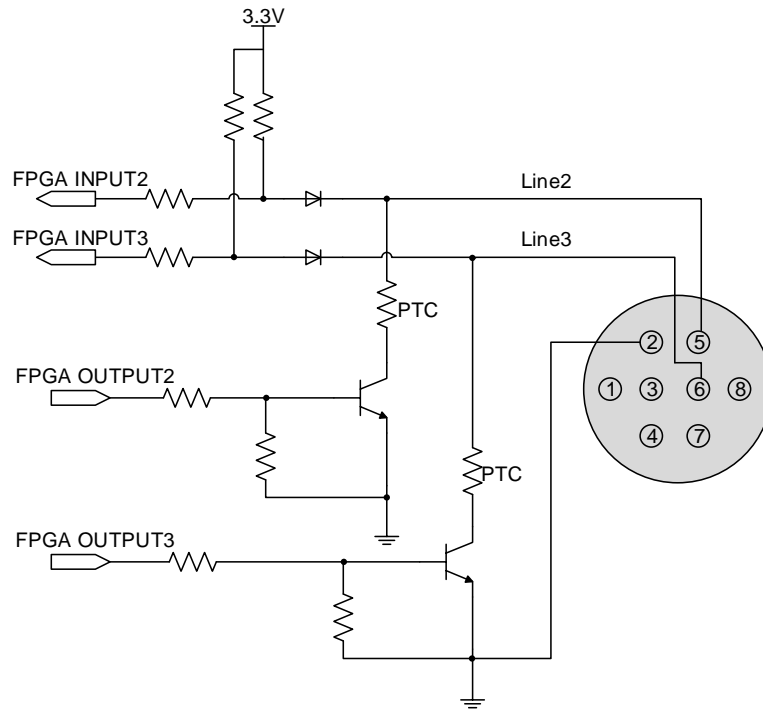

Figure 7-7 GPIO 2/3 (bidirectional) circuit

7.3.3.1. Line2/3 is Configured as Input

When Line2/3 is configured as input, the internal equivalent circuit of camera is shown in Figure 7-8, taking Line2 as an example:

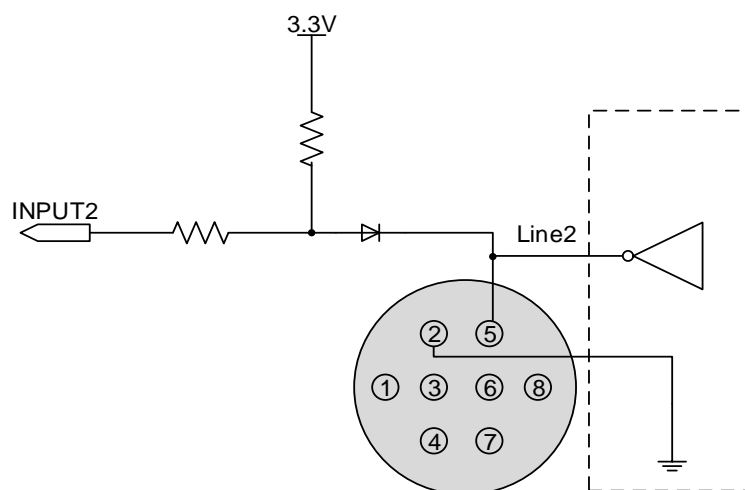

Figure 7-8 Internal equivalent circuit of camera when Line2 is configured as input



To avoid the damage of GPIO pins, please connect GND pin before supplying power to Line2/3.

- Logic 0 input voltage: 0V~+0.6V(Line2/3 voltage)
- Logic 1 input voltage: +1.9V~+24V(Line2/3 voltage)
- The status is unstable when input voltage is between 0.6V and 1.9V, which should be avoided
- When input of Line2/3 is high, input current is lower than 100μA. When input of Line2/3 is low, input current is lower than -1mA

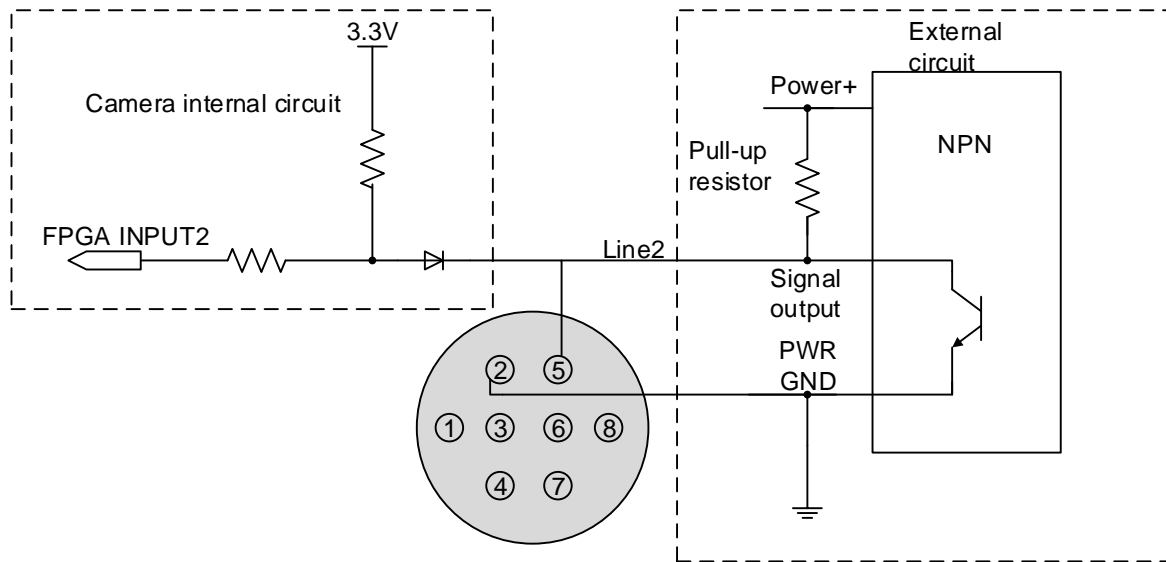

Figure 7-9 NPN photoelectric sensor connected to Line2 input circuit

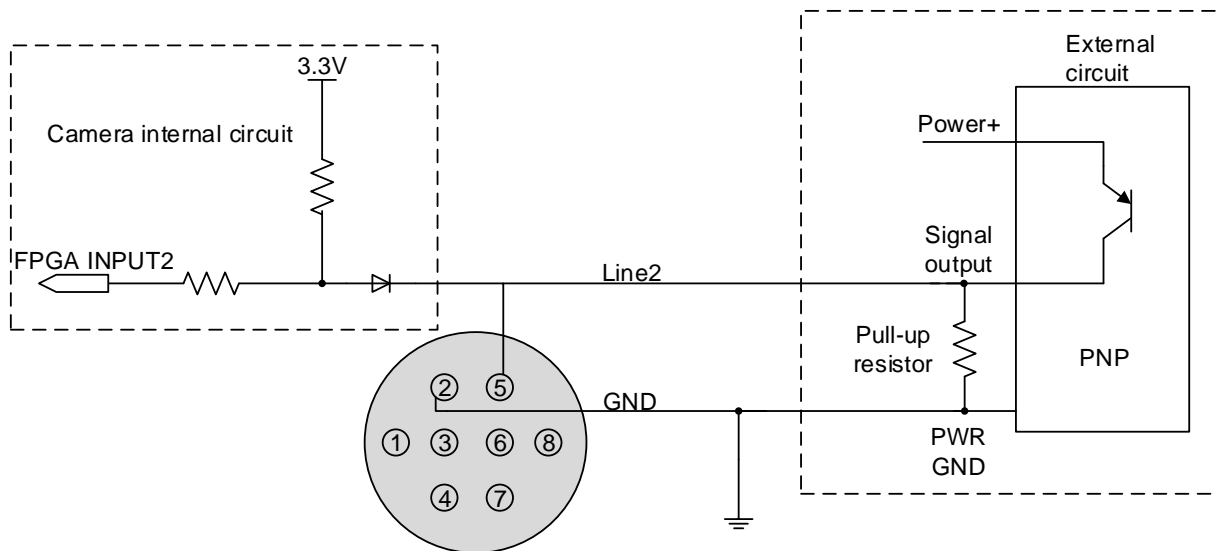

Figure 7-10 PNP photoelectric sensor connected to Line2 input circuit

When Lline2/3 is configured as input, pull-down resistor over 1K should not be used, otherwise the input voltage of Line2/3 will be over 0.6V and logic 0 cannot be recognized stably.

- Input rising time delay: <math><2\mu\text{s}</math> (0°C~45°C), parameter description as shown in Figure 7-4
- Input falling time delay: <math><2\mu\text{s}</math> (0°C~45°C), parameter description as shown in Figure 7-4

7.3.3.2. Line2/3 is Configured as Output

- Range of external voltage (EXVCC) is 5~24V
- Maximum output current of Line2/3 is 25mA, output impedance is 40Ω

Output voltage and output current in typical application conditions (temperature is 25°C) are shown in Table 7-7.

External voltage EXVCC	External resistance Rexternal	Line2/3 voltage (V)	Output current (mA)
5V	1kΩ	0.19	4.8
12V		0.46	11.6
24V		0.92	23.1

Table 7-7 Voltage and output current of Line2/3 in typical conditions

- Rising time delay = tr+td: <20μs (0°C~45°C) (parameter description as shown in Figure 7-6)
- Falling time delay = ts+tf: <20μs (0°C~45°C) (parameter description as shown in Figure 7-6)

Delay parameters are affected greatly by external voltage and external pull-up resistor, but little by temperature. Output delays in typical application conditions (temperature is 25°C) are shown in Table 7-8.

Parameter	Test Conditions	Value (μs)		
			~	
Storage time (ts)	External power is 5V, pull-up resistor is 1kΩ	0.17	~	0.18
Delay time (td)		0.08	~	0.09
Rising time (tr)		0.11	~	0.16
Falling time (tf)		1.82	~	1.94
Rising time delay = tr+td		0.19	~	0.26
Falling time delay = tf+ts		1.97	~	2.09

Table 7-8 Delay time when GPIO is configured as output in typical conditions

When Line2/3 is configured as output, the internal equivalent circuit of camera is shown in Figure 7-11, taking Line2 as an example.

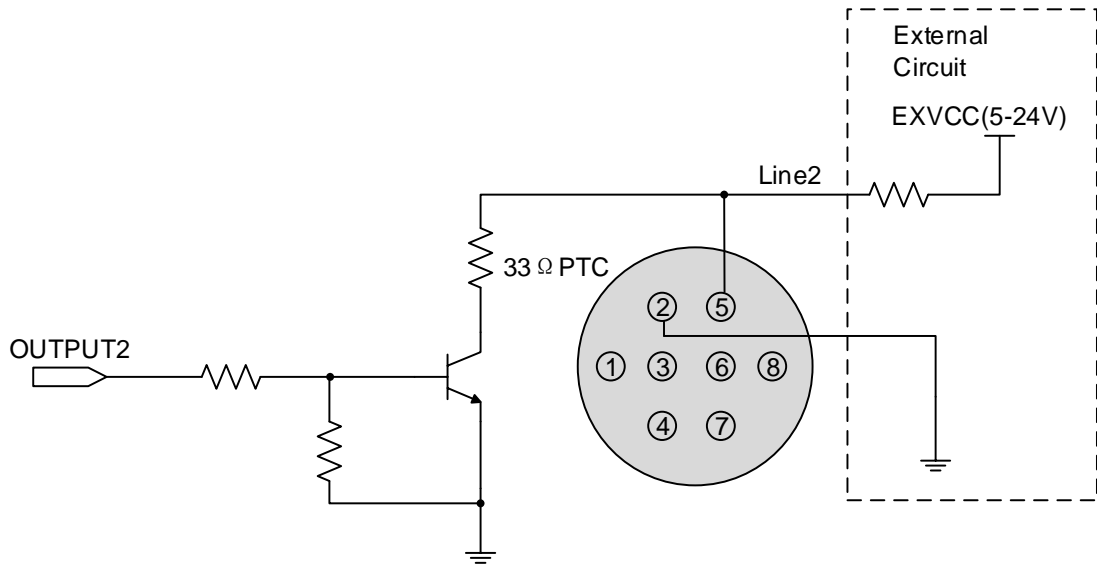

Figure 7-11 Internal equivalent circuit of camera when Line2 is configured as output

8. Features

8.1. I/O Control

8.1.1. Input Mode Operation

1) Configuring Line as input

The MER-G-P/MER-G series camera has three input signals: Line0, Line2, and Line3. In which the Line0 is uni-directional opto-isolated input, Line2 and Line3 are bi-directional lines which can be configured as input or output.

The camera's default input is Line0 when the camera is powered on. Line2 and Line3 are input by default, which can be configured to be input or output by LineMode.

2) Input Debouncer

In order to suppress the interference signals from hardware trigger, the MER-G-P/MER-G series camera has the hardware trigger filtering feature, including rising edge filtering and falling edge filtering. The user can set the trigger filter feature by setting the "TriggerFilterRaisingEdge" and the "TriggerFilterFallingEdge". The range of the trigger filter feature is [0, 5000] μ s, step: 1 μ s.

Example 1: Setting the rising edge filter width to 1ms, the pulse width less than 1ms in the rising edge will be filtered out, as shown in Figure 8-1:

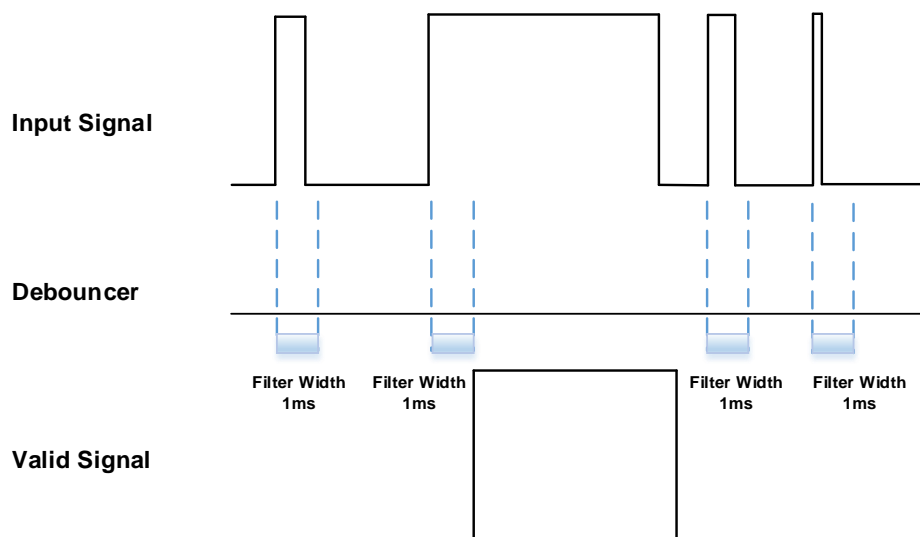

Figure 8-1 Input debouncer schematic diagram

3) Trigger Delay

The MER-G-P/MER-G series camera has trigger delay feature. The user can set the trigger delay feature by setting "TriggerDelay". The range of the trigger delay feature is [0, 3000000] μ s, step: 1 μ s.

Example 1: Setting the trigger delay value to 1000ms, and the trigger signal will be valid after 1000ms delay, as shown in Figure 8-2.

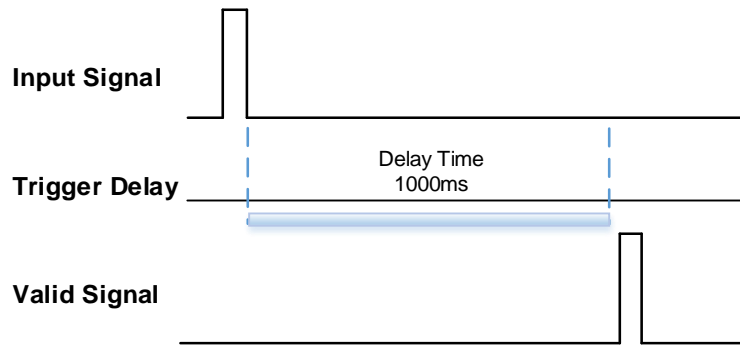

Figure 8-2 Trigger delay schematic diagram

4) Input Inverter

The signal level of input lines is configurable for the MER-G-P/MER-G series camera. The user can select whether the input level is reverse or not by setting "LineInverter".

For the MER-G-P/MER-G series camera, the default input line level is False when the camera is powered on, indicating that the input line level is not reversed. If it is set as True, indicating that the input line level is reversed. As shown in the Figure 8-3:

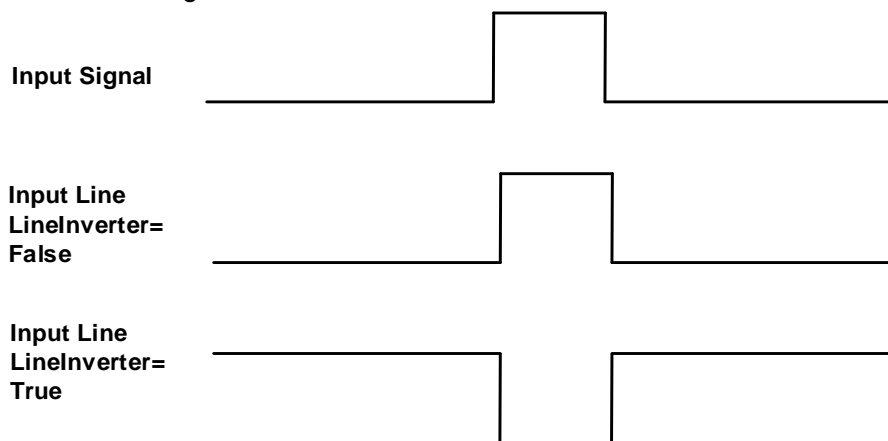

Figure 8-3 Setting input line reverse

8.1.2. Output Mode Operation

1) Configuring Line as output

The MER-G-P/MER-G series camera has three output signals: Line1, Line2, and Line3. In which the Line1 is a uni-directional opto-isolated output I/O, Line2 and Line3 are bi-direction configurable I/Os.

The camera's default output is Line1 when the camera is powered on. Line2 and Line3 can be configured to be output by changing the "LineMode" of this line.

Each output source of the three output lines can be configurable, and the output source includes: Strobe, UserOutput0, UserOutput1, UserOutput2.

The default output source of the camera is UserOutput0 when the camera is powered on.

2) Setting the user-defined status for the output lines

The MER-G-P/MER-G series camera can select the user-defined output by setting "LineSource", by setting "UserOutputValue" to configure the output signal.

By setting "UserOutputSelector" to select UserOutput0, UserOutput1 or UserOutput2.

By setting "UserOutputValue" to set the user-defined output value, and the default value is False when the camera is powered on.

3) Output Inverter

In order to facilitate the camera IO configuration and connection, the MER-G-P/MER-G series camera has the function of configurable output signal level. The user can select whether the output level is reversed or not by setting "LineInverter".

The default output signal level is False when the camera is powered on, indicating that the output line level is not reversed. If it is set as True, indicating that the output line level is reversed. As shown in the Figure 8-4.

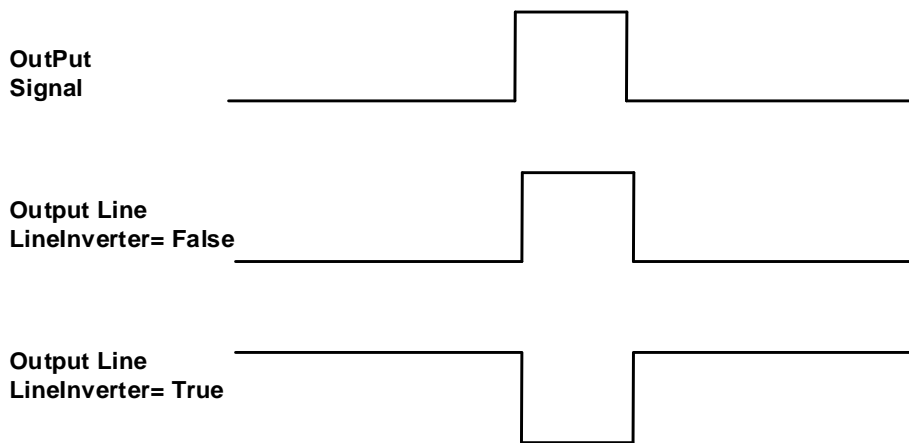

Figure 8-4 Set output line reversion

8.1.3. Read the LineStatus

1) Read the level of single line

The MER-G-P/MER-G series camera can get the line's signal status. When the device is powered on, the default status of Line0 and Line1 is False, and the default status of Line2 and Line3 is True.

2) Read all the lines level

The MER-G-P/MER-G series camera can get the current status of all lines. On the one hand, the signal status is the status of the external IO after the reversal of the polarity. On the other hand, signal status level can reflect the external IO level.

All the lines level status bit of the MER-G-P/MER-G series camera are shown in Table 8-1. The default polarity does not reverse, and the default value is 0xC.

Line3	Line2	Line1	Line0
1	1	0	0

Table 8-1 Camera line status bit

8.2. Image Acquisition Control

8.2.1. Acquisition Start and Stop

8.2.1.1. Acquisition Start

It can send **AcquisitionStart** command immediately after opening the camera. The acquisition process in continuous mode is illustrated in Figure 8-5, and the acquisition process in trigger mode is illustrated in Figure 8-6.

- **Continuous Acquisition**

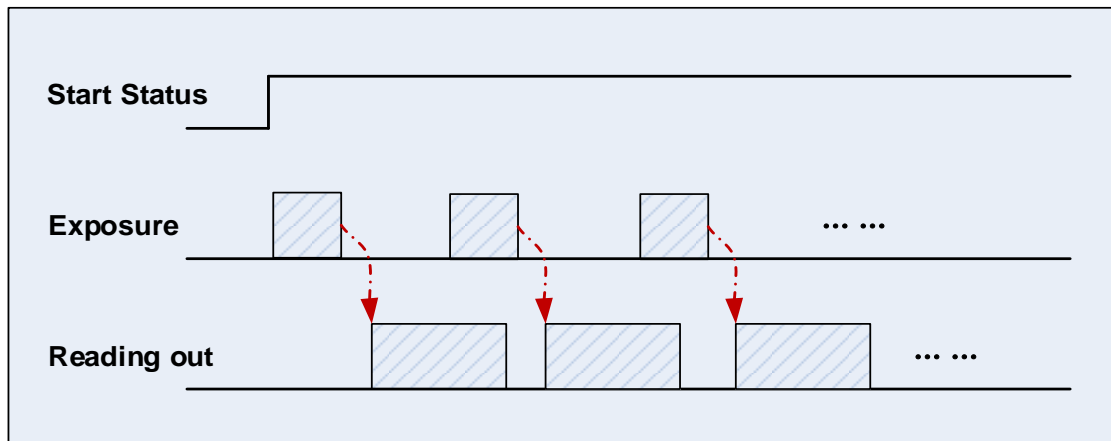

Figure 8-5 Continuous acquisition process

In continuous mode, a camera starts to expose and read out after receiving the **AcquisitionStart** command. The frame rate is determined by the exposure time, ROI and some other parameters.

- **Trigger Acquisition**

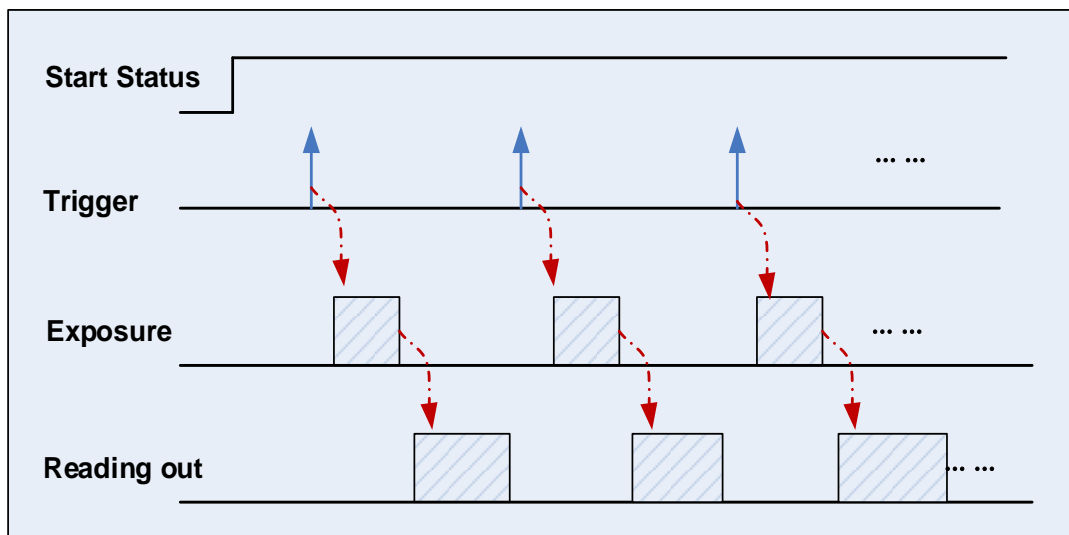

Figure 8-6 Trigger acquisition process

In trigger mode, sending **AcquisitionStart** command is not enough, a trigger signal is also needed. Each time a frame trigger is applied (including software trigger and hardware trigger), the camera will acquire and transmit a frame of image.

8.2.1.2. Acquisition Stop

It can send **AcquisitionStop** command to camera at any time. The acquisition stop process is irrelevant to acquisition mode. But different stop time will result in different process, as shown in Figure 8-7 and Figure 8-8.

- **Acquisition stop during reading out**

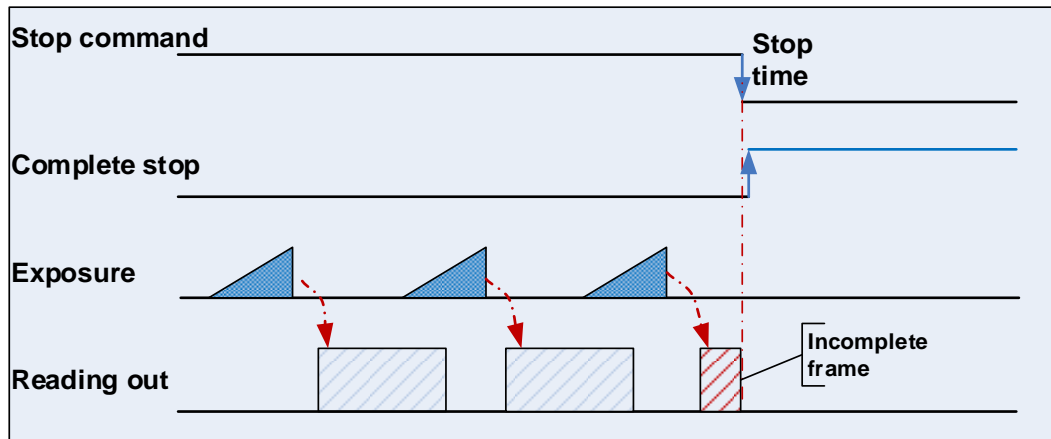

Figure 8-7 Acquisition stop during reading out

As shown in Figure 8-7, when the camera receives an acquisition stop command during reading out, it stops transferring frame data immediately. The currently transferred frame data is regarded as incomplete frame and will be discarded.

- **Acquisition stop during blanking**

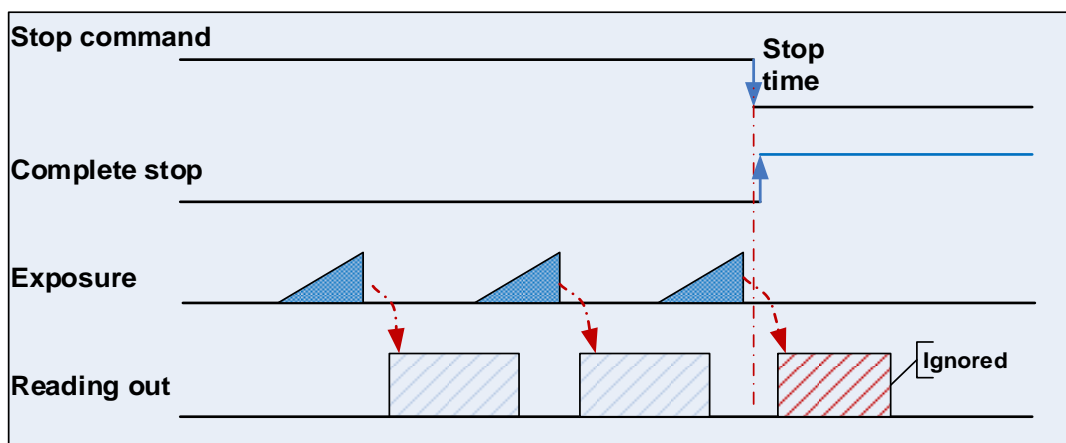

Figure 8-8 Acquisition stop during blanking

After the MER-G-P/MER-G camera transferred a whole frame, the camera goes into wait state. When user sends an **AcquisitionStop** command in wait state, the camera will return to stop acquisition state. The camera will not send any frames even if it is just going to start the next exposing.



Due to the limitations of the sensor's working mode, when you use the MER-133-54GM/C-P and MER-133-54GM/C cameras, you should pay attention to the following items:

After starting acquisition or stopping acquisition, you should wait for a period of time, at least, the time should be longer than the sum of the current exposure time and the frame period, and then you can execute other control command.

8.2.2. Switching Acquisition Mode

Two trigger mode are available: **ON** and **OFF**. When trigger mode is set **OFF**, the camera works in continuous mode; when trigger mode is set **ON**, the camera works in trigger mode. It can be switched between **ON** and **OFF** any time after the camera is opened.

As shown below, switching the acquisition mode at different positions will have different results.

- **Switch acquisition mode during frame reading out**

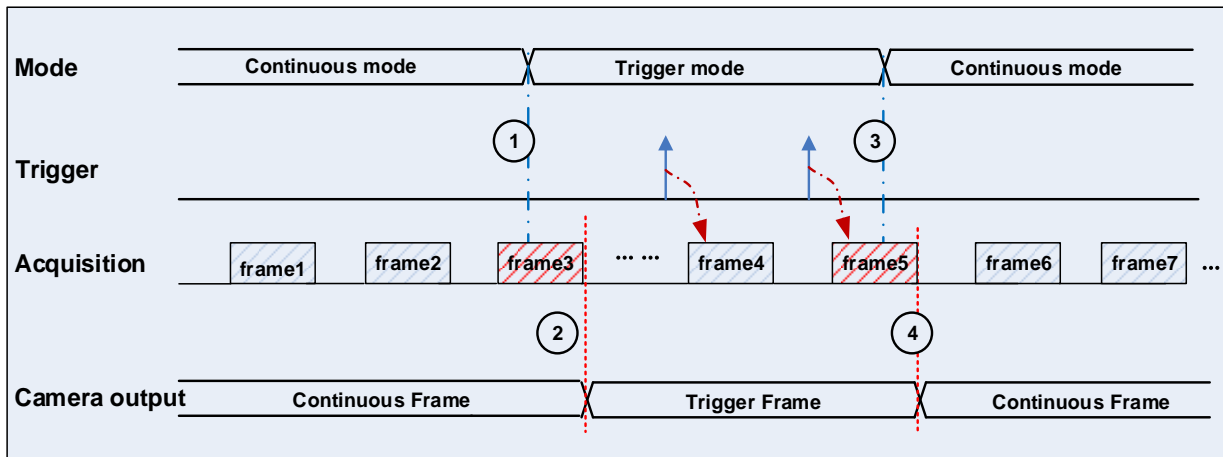

Figure 8-9 Switch acquisition mode during reading out

As shown in Figure 8-9, the camera starts with trigger mode **OFF** after receiving acquisition start command.

At point 1, the camera gets a command of setting trigger mode **ON** while transferring the 3rd frame in trigger mode OFF. The trigger mode is not active until the 3rd frame is finished, at point 2, and then the trigger signal will be accepted. At point 3, the camera gets a command of switching back to **OFF**. It is also not active until the 5th frame is finished, it should wait a complete reading out. The camera actually switches from trigger mode to continuous mode at point 4, and then the camera works in continuous mode.

- **Switch acquisition mode during blanking (or exposure)**

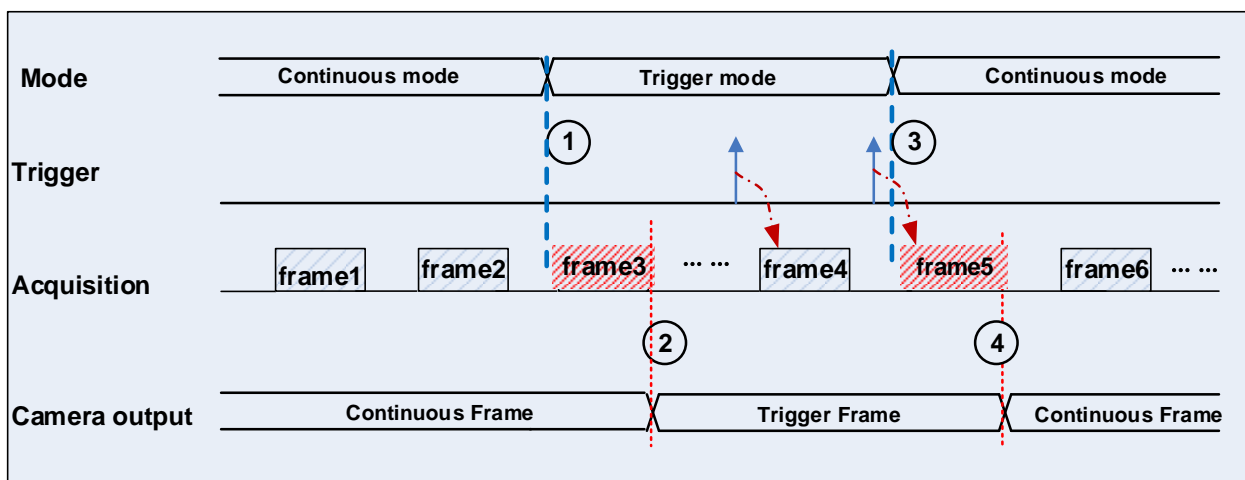

Figure 8-10 Switch acquisition mode in waiting time

As shown in Figure 8-10, the camera with trigger mode **OFF** begins after receiving an **AcquisitionStart** command.

At point 1, the camera gets a command of setting trigger mode **ON** while it is in wait state. The trigger mode is not active until the 3th frame is finished (including exposure and reading out), i.e., point 2. Please note that the 3rd frame does not belong to trigger mode. All trigger frames need trigger signals or soft-trigger commands. At point 3, the camera gets a command of switching back to continuous mode. It is also not active until the 5th frame is finished, it should wait a complete frame. The camera switches from trigger mode to continuous mode at point 4 actually, and then the camera works in continuous mode.

Due to the limitations of the sensor's working mode, when you use the MER-131-75GM/C-P, MER-131-75GM/C, MER-031-300GM/C-P, MER-031-300GM/C, MER-050-200GM/C-P, and MER-050-200GM/C, MER-133-54GM/C-P, MER-133-54GM/C cameras, you should pay attention to the following items:



- 1) Avoiding switching the acquisition mode during acquiring an image.
- 2) After setting the trigger mode, you should wait for a period of time, at least, the time should be longer than the sum of the current exposure time and the frame period, and then you can start acquiring images.

8.2.3. Continuous Mode and Configuration

● Continuous mode configuration

The default value of **Trigger Mode** is **OFF** in default user set. If the camera is opened with default user set, the camera works in continuous mode directly. Otherwise, user can set **Trigger Mode OFF** to use continuous mode.

Other parameters also can be changed in **Trigger Mode OFF**.

● Continuous mode features

In continuous acquisition mode, the camera acquires and transfers images according to camera parameter settings.



In continuous mode, ROI size, Packet delay may have effects on frame rate.

8.2.4. Software Trigger Acquisition and Configuration

● Software trigger acquisition configuration

The camera supports software trigger acquisition mode. Three steps followed should be ensured.

- 1) Set the Trigger Mode to ON.
- 2) Set the Trigger Source to Software.
- 3) Send Software Trigger command.

All the software trigger commands are sent by the host through the Gigabit Ethernet bus, to trigger the camera to capture and transmission images.

- **Software trigger acquisition features**

In software trigger acquisition mode, the camera begins to acquire one image after receiving software trigger commands. In general, the number of frames is equal to the number of software trigger commands. The relative features are illustrated below:

- 1) In software trigger acquisition mode, if the trigger frequency is lower than permissible maximal FPS (Frame per Second) of the camera, the current frame rate is trigger frequency. If the trigger frequency is higher than permissible maximal FPS (Frame per Second) of the camera, some software triggers are ignored and the current frame rate is lower than trigger frequency.
- 2) The trigger delay feature can control the camera delay interval between your triggers and the camera acquiring frames. The default value of trigger delay time is zero.

8.2.5. Hardware Trigger Acquisition and Configuration

- **Hardware trigger acquisition configuration**

The camera supports hardware trigger acquisition mode. Three steps followed should be ensured:

- 1) Set the Trigger Mode to ON.
- 2) Set the Trigger Source to Line0, Line2 or Line3.
- 3) Connect hardware trigger signal to Line0.

If the Trigger Source is set by Line2 or Line3, it should be ensured that the corresponding Line is set as Input.

Please refer to section 8.1.1 for more information of the programmable GPIO interfaces.

- **Hardware trigger acquisition features**

The relative features about the camera's trigger signal process are illustrated below:

- 1) The polarity of lines can be set to inverted or not inverted, and the default setting is not inverted.
- 2) Improper signal can be filtered by setting appropriate value to trigger filter. Raising edge filter and falling edge can be set separately. The range is from 0 to 5000 μ s. The default configuration is not use trigger filter.
- 3) The time interval between trigger and exposure can be through the trigger delay feature. The range of time interval covers from 0 to 3000000 μ s. The default value of trigger delay time is zero.

The features, like trigger polarity, trigger delay and trigger filter, can be select in the GalaxyView.



The camera's trigger source Line0 use opto-isolated circuit to isolate signal. Its internal circuit delay trigger signal and rising edge's delay time is less than falling edge's. There are a dozen clock cycles delay of rising edge and dozens clock cycles delay of falling edge. If you use Line0 to trigger the camera, the positive pulse signal's positive width will be wider (about 20-40 μ s) and the negative pulse signal's negative width will be narrower (about 20-40 μ s). You can adjust filter parameter to accurately filter trigger signal.

● **Exposure delay**

When an external trigger signal is received to the sensor to start exposure, there is a small delay, which is called the exposure delay and consists of four parts of time, as shown in Figure 8-11.

T1: The delay introduced by the hardware circuit when the external signal passes through the optocoupler or GPIO. The value is generally in the range of a few μs to several tens of μs . The delay is mainly affected by the connection mode, driving intensity and temperature. When the external environment is constant, the delay is generally stable.

T2: Delay introduced by the trigger filter. For example, if the trigger filter time is set to $50\mu\text{s}$, T2 is $50\mu\text{s}$.

T3: Trigger delay (trigger_delay), the camera supports trigger delay feature. If the trigger delay is set to $200\mu\text{s}$, T3 is $200\mu\text{s}$.

T4: The sensor timing sequence delay, the internal exposure of the sensor is aligned with the row timing sequence, so T4 has a maximum row cycle jitter. The value of each sensor is different. Some products with large delay time (several hundred μs or more) have additional configuration time counted in T4.

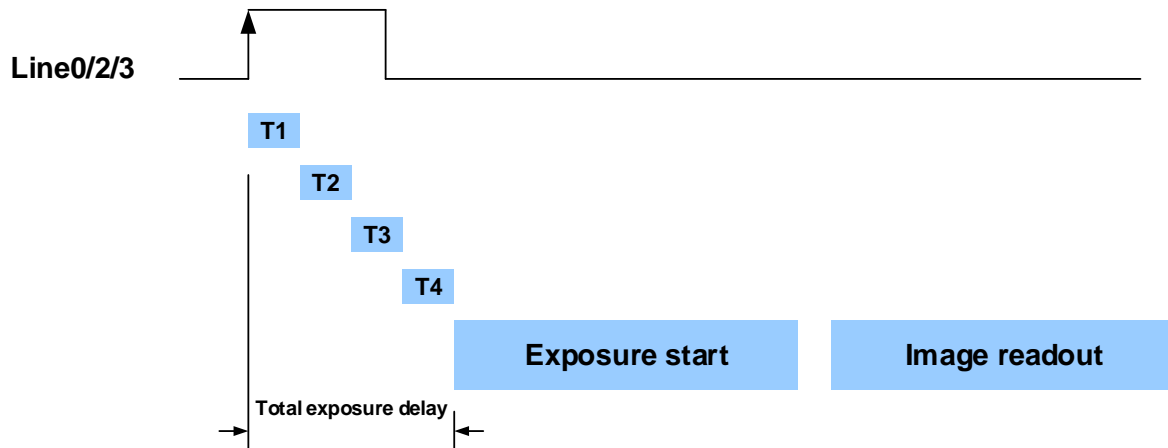

Figure 8-11 Exposure delay

The following table shows the total exposure delay time for each sensor.

T1 is calculated according to the typical delay ($5\mu\text{s}$) of line0. If it is line2/3, T1 can be ignored.

T2 is calculated as $0\mu\text{s}$.

T3 is calculated as $0\mu\text{s}$.

T4 is calculated according to the ROI settings and features of each sensor.

The exposure delay data for each model is as follows:

Model	Exposure delay (μs)
MER-030-120GM/C-P	5~21
MER-030-120GM/C	5~21

MER-031-300GM/C-P	5~12
MER-031-300GM-P NIR	5~12
MER-031-300GM/C	5~12
MER-032-120GM/C-P	5~21
MER-032-120GM/C	5~21
MER-041-302GM/C-P	5~10
MER-041-302GM/C	5~10
MER-050-200GM-P NIR	5~12
MER-050-200GM/C	5~12
MER-051-120GM/C-P	5~18
MER-051-120GM/C	5~18
MER-125-30GM/C-P	5~38
MER-125-30GM/C	5~38
MER-130-30GM	5~37
MER-131-75GM/C-P	5~14
MER-131-75GM-P NIR	5~14
MER-131-75GM/C	5~14
MER-132-30GM/C	5~37
MER-132-43GM/C	5~27
MER-132-43GM/C	5~27
MER-133-54GM/C	5~24
MER-133-54GM/C-P	5~24
MER-200-14GM/C	5~58
MER-200-20GM/C-P	5~37

MER-200-20GM/C	5~37
MER-201-25GM/C	5~37
MER-201-25GM/C-P	5~37
MER-231-41GM/C-P	5~25
MER-231-41GM/C	5~25
MER-232-48GM-P NIR	5~17
MER-500-14GM/C-P	5~41
MER-500-14GM/C	5~41
MER-503-20GM/C	5~29
MER-503-20GM/C-P	5~29
MER-504-10GM/C-P	5~54
MER-530-20GM-P NIR	5~27
MER-531-20GM/C-P	5~27
MER-630-16GM/C-P	2885~2904
MER-630-16GM/C	2885~2904
MER-1070-10GM/C-P	6620~6639
MER-1070-10GM/C	6620~6639
MER-1220-9GM/C-P	1426~1449
MER-1220-9GM/C	1426~1449
MER-1520-7GC-P	5805~5827
MER-1520-7GC	5805~5827
MER-2000-5GM/C-P	2005~2036
MER-2000-5GM/C	2005~2036

8.2.6. Set Exposure

- **Global Shutter**

The implementation process of global shutter is as shown in Figure 8-12, all the lines of the sensor are exposed at the same time, and then the sensor will read out the image data one by one.

The advantage of the global shutter is that all the lines are exposed at the same time, and the images do not appear offset and distortion when capturing moving objects.

The time width of the flash signal can be got by the following formula:

$$T_{strobe} = T_{exposure}$$

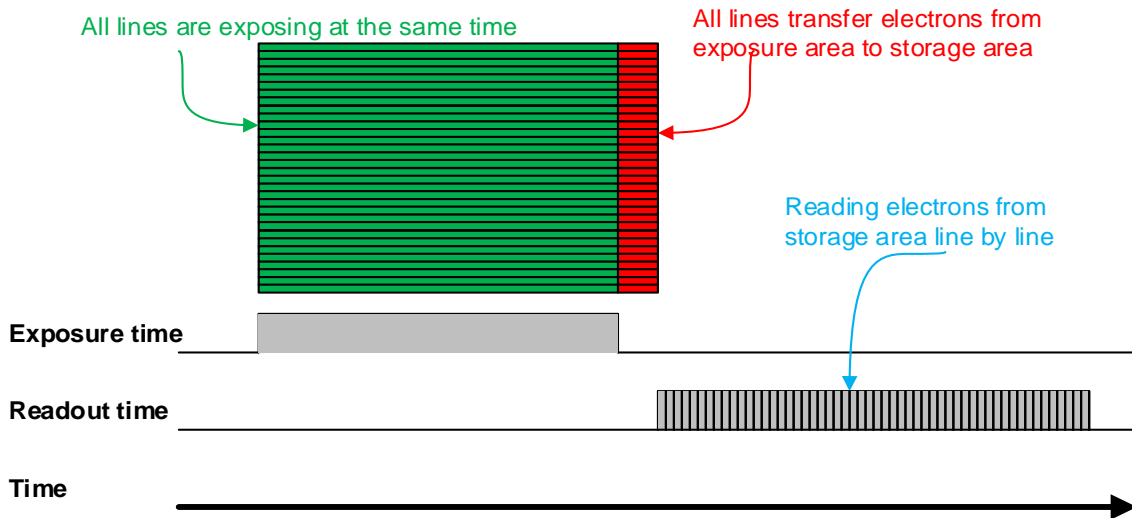

Figure 8-12 Global Shutter

- **Electronic Rolling Shutter**

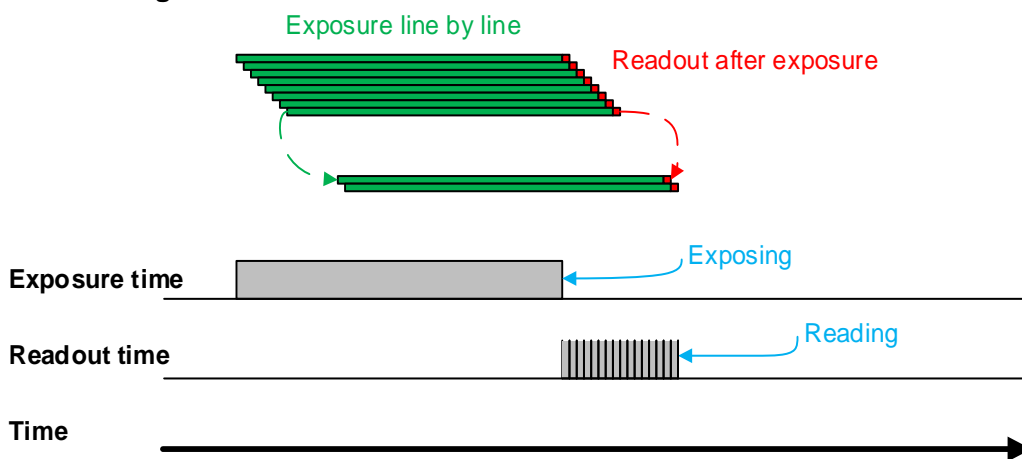

Figure 8-13 Electronic rolling shutter

The implementation process of electronic rolling shutter is as shown in Figure 8-13, different from the global shutter, electronic rolling shutter exposes from the first line, and starts the second line exposure after a row period. And so on, after N-1 line, the N line starts exposing. When the first line exposure ends, it begins to read out the data, and it need a row period time to read out one line (including the line blanking time). When the first line reads out completely, the second line just begins to read out, and so on, when the N-1 line is read out, the N line begins to read out, until the whole image is read out completely.

The electronic rolling shutter has low price and high resolution, which is a good choice for some static image acquisition.

The time width of the flash signal can be got by the following formula:

$$T_{strobe} = T_{exposure} - (N - 1) * T_{row}$$

- **Setting the exposure time**

The MER-G-P/MER-G series camera supports setting the exposure time, step: 1μs. The exposure time is shown as follows:

Model	Exposure Mode	Adjustment Range (μs)	Steps (μs)	Actual Steps
MER-030-120GM/C-P	Global Shutter	4-1000000	1	1
MER-030-120GM/C	Global Shutter	4-1000000	1	1
MER-031-300GM/C-P	Global Shutter	20-1000000	1	1
MER-031-300GM-P NIR	Global Shutter	20-1000000	1	1
MER-031-300GM/C	Global Shutter	20-1000000	1	1
MER-032-120GM/C-P	Global Shutter	20-1000000	1	1
MER-032-120GM/C	Global Shutter	20-1000000	1	1
MER-041-302GM/C-P	Global Shutter	20-1000000	1	1 row period
MER-041-302GM/C	Global Shutter	20-1000000	1	1 row period
MER-050-200GM-P NIR	Global Shutter	20-1000000	1	1
MER-050-200GM/C	Global Shutter	20-1000000	1	1
MER-051-120GM/C-P	Global Shutter	1-1000000	1	1
MER-051-120GM/C	Global Shutter	1-1000000	1	1
MER-125-30GM/C-P	Global Shutter	20-1000000	1	1
MER-125-30GM/C	Global Shutter	20-1000000	1	1
MER-130-30GM	Rolling Shutter	28-500000	1	1 row period*
MER-131-75GM/C-P	Global Shutter	1-1000000	1	1
MER-131-75GM-P NIR	Global Shutter	1-1000000	1	1
MER-131-75GM/C	Global Shutter	1-1000000	1	1
MER-132-30GM/C	Global Shutter	8-1000000	1	1

MER-132-43GM/C	Global Shutter	6-1000000	1	1
MER-132-43GM/C	Global Shutter	6-1000000	1	1
MER-133-54GM/C	Global Shutter	20-1000000	1	1
MER-133-54GM/C-P	Global Shutter	20-1000000	1	1
MER-200-14GM/C	Global Shutter	20-1000000	1	1
MER-200-20GM/C-P	Global Shutter	20-1000000	1	1
MER-200-20GM/C	Global Shutter	20-1000000	1	1
MER-201-25GM/C	Global Shutter	13-1000000	1	1
MER-201-25GM/C-P	Global Shutter	13-1000000	1	1
MER-203-30GC-P-L	Rolling Shutter	20-1000000	1	stepped exposure
MER-203-30GC-P-L-F03	Rolling Shutter	20-1000000	1	stepped exposure
MER-204-30GC-P-L-F02	Rolling Shutter	20-1000000	1	stepped exposure
MER-231-41GM/C-P	Global Shutter	20-1000000	1	1 row period
MER-231-41GM/C	Global Shutter	20-1000000	1	1 row period
MER-232-48GM-P NIR	Global Shutter	1-1000000	1	1
MER-500-14GM/C-P	Rolling Shutter	36-1000000	1	1 row period*
MER-500-14GM/C	Rolling Shutter	36-1000000	1	1 row period*
MER-503-20GM/C	Global Shutter	20-1000000	1	1 row period
MER-503-20GM/C-P	Global Shutter	20-1000000	1	1 row period
MER-504-10GM/C-P	Global Shutter	20-1000000	1	1
MER-530-20GM-P NIR	Global Shutter	5-1000000	1	1
MER-531-20GM/C-P	Global Shutter	5-1000000	1	1
MER-630-16GM/C-P	Rolling Shutter	19-1000000	1	1 row period
MER-630-16GM/C	Rolling Shutter	19-1000000	1	1 row period
MER-1070-10GM/C-P	Rolling Shutter	42-1000000	1	1 row period
MER-1070-10GM/C	Rolling Shutter	42-1000000	1	1 row period
MER-1220-9GM/C-P	Rolling Shutter	23-1000000	1	1 row period

MER-1220-9GM/C	Rolling Shutter	23-1000000	1	1 row period
MER-1520-7GC-P	Rolling Shutter	42-1000000	1	1 row period
MER-1520-7GC	Rolling Shutter	42-1000000	1	1 row period
MER-2000-5GM/C-P	Rolling Shutter	31-1000000	1	1 row period
MER-2000-5GM/C	Rolling Shutter	31-1000000	1	1 row period

Table 8-2 MER-G-P/MER-G series camera exposure time setting range

* The exposure precision of the camera is limited by the sensor, when the steps in the user's interface and the demo display as 1 μ s, actually the steps is one row period. When the value of the ExposureTime cannot be divisible by the row period, round up to an integer should be taken, such as the row period is 36 μ s, setting 80 μ s exposure time, and the actual exposure time is 108 μ s.

When the external light source is sunlight or direct current (DC), the camera has no special requirements for the exposure time. When the external light source is alternating current (AC), the exposure time must synchronize with the external light source (under 50Hz light source, the exposure time must be a multiple of 1/100s, under 60Hz light source, the exposure time must be a multiple of 1/120s), to ensure better image quality. You can set the exposure time that is synchronized with the external light source by using the demo or interface function.

The MER-G-P/MER-G series camera supports Auto Exposure feature. If the Auto Exposure feature is enabled, the camera can adjust the exposure time automatically according to the environment brightness. See section 8.3.4 for details.

The stepped exposure correspondence of MER-203-30GC-P-L, MER-203-30GC-P-L-F03 and MER-204-30GC-P-L-F02 is as follows:

Userset Exposure Time (s)	Actual Exposure Time (s)
1/50000	1/50000
(1/50000,1/10000)	1/10000
(1/10000,1/5000)	1/5000
(1/5000,1/2000)	1/2000
(1/2000,1/1000)	1/1000
(1/1000,1/480)	1/480
(1/480,1/240)	1/240
(1/240,1/100)	1/100
(1/100,1/60)	1/60

(1/60,1/30)	1/30
(1/30,2/30)	2/30
(2/30,4/30)	4//30
(4/30,6/30)	6/30
(6/30,8/30)	8/30
(8/30,10/30)	10/30
(10/30,15/30)	15/30
(15/30,20/30)	20/30
(20/30,25/30)	25/30
(25/30,30/30)	30/30

8.2.7. Overlap Exposure and Non-overlap Exposure

There are two stages in image acquisition of the MER-G-P/MER-G series camera: exposure and readout. Once the camera is triggered, it begins to integrate and when the integration is over, the image data will be read out immediately.

The MER-G-P/MER-G series camera supports two exposure modes: overlap exposure and non-overlap exposure. The user cannot assign the overlap exposure or non-overlap exposure directly, it depends on the frequency of trigger signal and the exposure time. The exposure modes are described as below.

- **Non-overlap exposure**

In non-overlap exposure mode, after the exposure and readout of the current frame are completed, then the next frame will expose and read out. As shown in the Figure 8-14, the Nth frame is read out, after a period of time, the N+1th frame to be exposed.

The formula of non-overlap exposure frame period:

$$\text{non-overlap exposure frame period} > \text{exposure time} + \text{readout time}$$

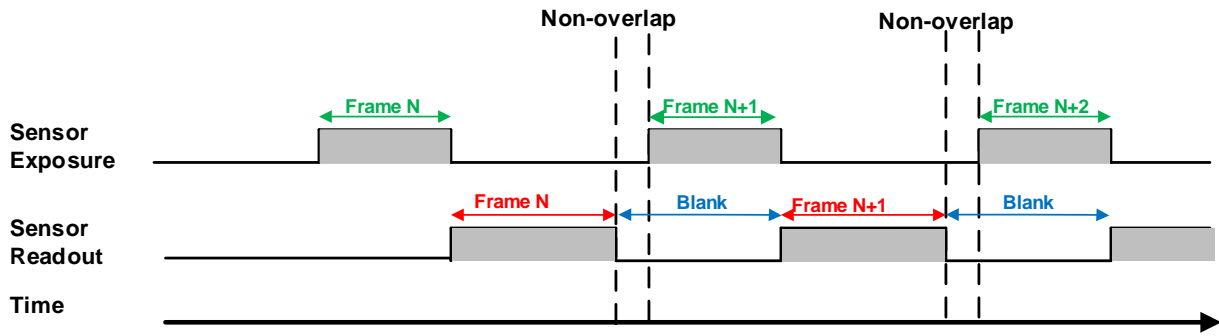

Figure 8-14 The exposure sequence diagram in non-overlap exposure mode

● **Trigger acquisition mode**

If the interval between two triggers is greater than the sum of the exposure time and readout time, it will not occur overlap exposure, as shown in Figure 8-15.

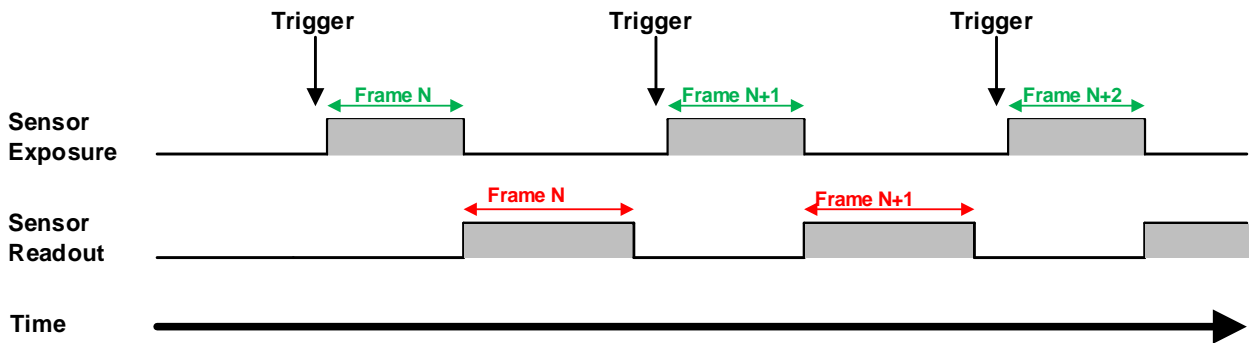

Figure 8-15 The trigger acquisition exposure sequence diagram in non-overlap exposure mode

● **Overlap exposure**

In overlap exposure mode, the current frame image exposure process is overlap with the readout of the previous frame. That is, when the previous frame is reading out, the next frame image has been started exposure. As shown in the Figure 8-16, when the Nth frame image is reading out, the N+1th frame image has been started exposure.

The formula of overlap exposure frame period:

$$\text{overlap exposure frame period} \leq \text{exposure time} + \text{readout time}$$

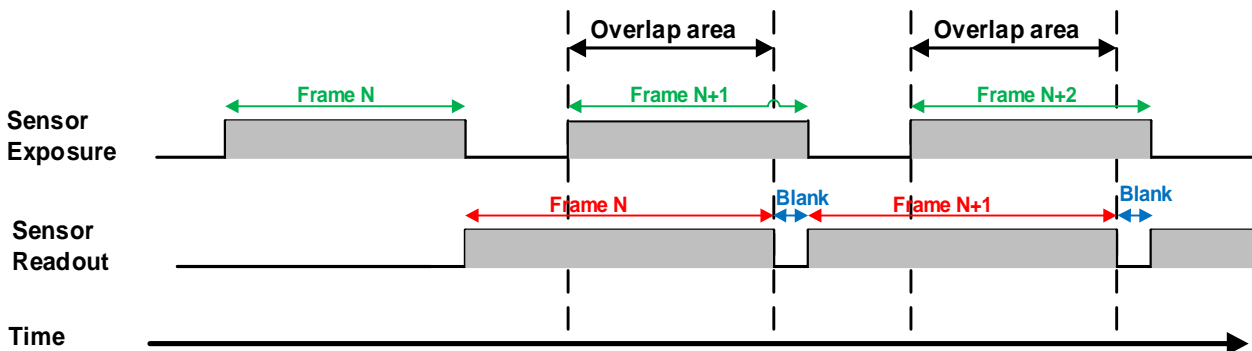

Figure 8-16 The exposure sequence diagram in overlap exposure mode

- **Continuous acquisition mode**

If the exposure time is greater than the frame blanking time, the exposure time and the readout time will be overlapped. As shown in the Figure 8-16.

- **Trigger acquisition mode**

When the interval between two triggers is less than the sum of exposure time and the readout time, it will occur overlap exposure, as shown in Figure 8-17.

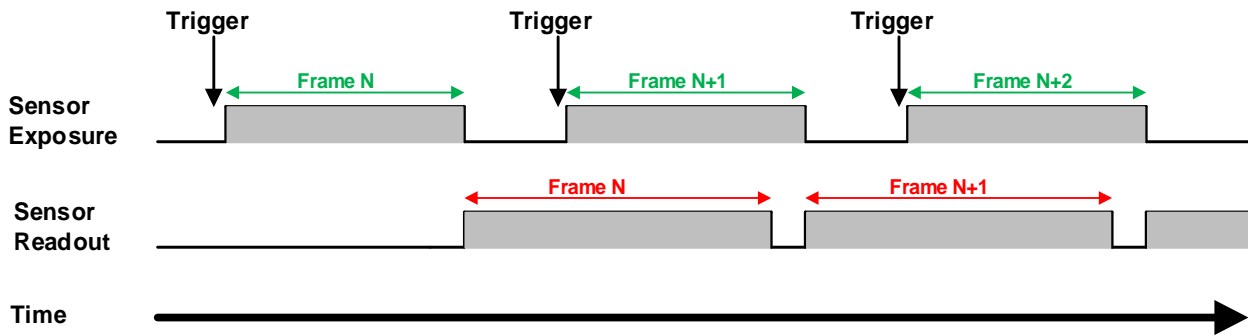

Figure 8-17 The trigger acquisition exposure sequence diagram in overlap exposure mode

Compared with non-overlap exposure mode, in overlap exposure mode, the camera can obtain higher frame rate.

8.3. Basic Features

8.3.1. Gain

The MER-G-P/MER-G series camera can adjust the analog gain, and the range of analog gain is as follows:

Model	Adjustment Range	Default/Steps
MER-030-120GM/C-P	0-25dB	0dB, 0.1dB
MER-030-120GM/C	0-25dB	0dB, 0.1dB
MER-031-300GM/C-P	0-16dB	0dB, 0.1dB
MER-031-300GM-P NIR	0-16dB	0dB, 0.1dB
MER-031-300GM/C	0-16dB	0dB, 0.1dB
MER-032-120GM/C-P	0-25dB	0dB, 0.1dB
MER-032-120GM/C	0-25dB	0dB, 0.1dB
MER-041-302GM/C-P	0-24dB	0dB, 0.1dB
MER-041-302GM/C	0-24dB	0dB, 0.1dB
MER-050-200GM-P NIR	0-16dB	0dB, 0.1dB
MER-050-200GM/C	0-16dB	0dB, 0.1dB

MER-051-120GM/C-P	0-16dB	0dB, 0.1dB
MER-051-120GM/C	0-16dB	0dB, 0.1dB
MER-125-30GM/C-P	0-25dB	0dB, 0.1dB
MER-125-30GM/C	0-25dB	0dB, 0.1dB
MER-130-30GM	0-16dB	0dB, 0.1dB
MER-131-75GM/C-P	0-16dB	0dB, 0.1dB
MER-131-75GM-P NIR	0-16dB	0dB, 0.1dB
MER-131-75GM/C	0-16dB	0dB, 0.1dB
MER-132-30GM/C	0-25dB	0dB, 0.1dB
MER-132-43GM/C-P	0-25dB	0dB, 0.1dB
MER-132-43GM/C	0-25dB	0dB, 0.1dB
MER-133-54GM/C	0-31dB	0dB, 0.1dB
MER-133-54GM/C-P	0-31dB	0dB, 0.1dB
MER-200-14GM/C	0-25dB	0dB, 0.1dB
MER-200-20GM/C-P	0-25dB	0dB, 0.1dB
MER-200-20GM/C	0-25dB	0dB, 0.1dB
MER-201-25GM/C-P	0-25dB	0dB, 0.1dB
MER-201-25GM/C	0-25dB	0dB, 0.1dB
MER-203-30GC-P-L	-	-
MER-203-30GC-P-L-F03	-	-
MER-204-30GC-P-L-F02	-	-
MER-231-41GM/C-P	0-24dB	0dB, 0.1dB
MER-231-41GM/C	0-24dB	0dB, 0.1dB
MER-232-48GM-P NIR	0-16dB	0dB, 0.1dB
MER-500-14GM/C-P	0-17dB	0dB, 0.1dB
MER-500-14GM/C	0-17dB	0dB, 0.1dB
MER-503-20GM/C	0-23.9dB	0dB, 0.1dB
MER-503-20GM/C-P	0-23.9dB	0dB, 0.1dB

MER-504-10GM/C-P	0-25dB	0dB, 0.1dB
MER-530-20GM-P NIR	0-16dB	0dB, 0.1dB
MER-531-20GM/C-P	0-16dB	0dB, 0.1dB
MER-630-16GM/C-P	0-24dB	0dB, 0.1dB
MER-630-16GM/C	0-24dB	0dB, 0.1dB
MER-1070-10GM/C-P	0-25.9dB	0dB, 0.1dB
MER-1070-10GM/C	0-25.9dB	0dB, 0.1dB
MER-1220-9GM/C-P	0-24dB	0dB, 0.1dB
MER-1220-9GM/C	0-24dB	0dB, 0.1dB
MER-1520-7GC-P	0-22.5dB	0dB, 0.1dB
MER-1520-7GC	0-22.5dB	0dB, 0.1dB
MER-2000-5GM/C-P	0-24dB	0dB, 0.1dB
MER-2000-5GM/C	0-24dB	0dB, 0.1dB

Table 8-3 MER-G-P/MER-G series camera analog gain adjustment range

When the analog gain changes, the response curve of the camera changes, as shown in Figure 8-18. The horizontal axis represents the output signal of the sensor in the camera, and the vertical axis represents the gray value of the output image. When the amplitude of the sensor output signal remains constant, increasing the gain makes the response curve steeper, and that makes the image brighter. For every 6dB increases of the gain, the gray value of the image will double. For example, when the camera has a gain of 0dB, the image gray value is 126, and if the gain is increased to 6dB, the image gray will increase to 252. Thus, increasing gain can be used to increase image brightness. When the environment brightness and exposure time keep constant, another way to increase the image brightness is to change the camera's digital gain by modifying the lookup table.

Note that increasing the analog gain or digital gain will amplify the image noise.

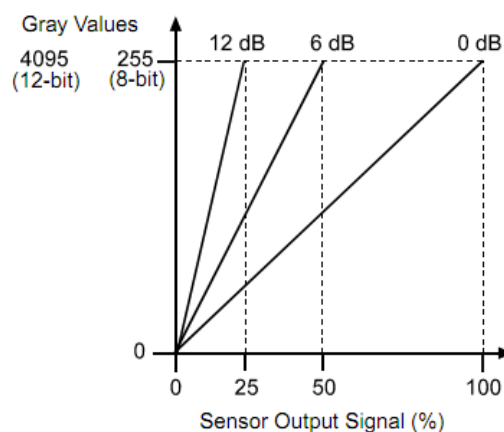

Figure 8-18 The camera's response curve

8.3.2. Pixel Format

By setting the pixel format, the user can select the format of output image. The available pixel formats depend on the camera model and whether the camera is monochrome or color. The following table shows the pixel format supported by the camera.

Model	Pixel Format
MER-030-120GM/C-P	Mono8, Mono12, BayerRG8, BayerRG12
MER-030-120GM/C	Mono8, Mono12, BayerRG8, BayerRG12
MER-031-300GM/C-P	Mono8, Mono10, BayerRG8, BayerRG10
MER-031-300GM-P NIR	Mono8, Mono10
MER-031-300GM/C	Mono8, Mono10, BayerRG8, BayerRG10
MER-032-120GM/C-P	Mono8, Mono12, BayerRG8, BayerRG12
MER-032-120GM/C	Mono8, Mono12, BayerRG8, BayerRG12
MER-041-302GM/C-P	Mono8, Mono12, BayerRG8, BayerRG12
MER-041-302GM/C	Mono8, Mono12, BayerRG8, BayerRG12
MER-050-200GM/C-P	Mono8, Mono10, BayerRG8, BayerRG10
MER-050-200GM-P NIR	Mono8, Mono10
MER-050-200GM/C	Mono8, Mono10, BayerRG8, BayerRG10
MER-051-120GM/C-P	Mono8, Mono10, BayerRG8, BayerRG10
MER-051-120GM/C	Mono8, Mono10, BayerRG8, BayerRG10
MER-125-30GM/C-P	Mono8, Mono12, BayerRG8, BayerRG12
MER-125-30GM/C	Mono8, Mono12, BayerRG8, BayerRG12
MER-130-30GM	Mono8, Mono10
MER-131-75GM/C-P	Mono8, Mono10, BayerRG8, BayerRG10
MER-131-75GM-P NIR	Mono8, Mono10
MER-131-75GM/C	Mono8, Mono10, BayerRG8, BayerRG10
MER-132-30GM/C	Mono8, Mono12, BayerRG8, BayerRG12

MER-132-43GM/C-P	Mono8, Mono12, BayerRG8, BayerRG12
MER-132-43GM/C	Mono8, Mono12, BayerRG8, BayerRG12
MER-133-54GM/C	Mono8, Mono10, BayerGR8, BayerGR10
MER-133-54GM/C-P	Mono8, Mono10, BayerGR8, BayerGR10
MER-200-14GM/C	Mono8, Mono12, BayerRG8, BayerRG12
MER-200-20GM/C-P	Mono8, Mono12, BayerRG8, BayerRG12
MER-200-20GM/C	Mono8, Mono12, BayerRG8, BayerRG12
MER-201-25GM/C-P	Mono8, Mono12, BayerRG8, BayerRG12
MER-201-25GM/C	Mono8, Mono12, BayerRG8, BayerRG12
MER-203-30GC-P-L	Mono8, BayerRG8
MER-203-30GC-P-L-F03	Mono8, BayerRG8
MER-204-30GC-P-L-F02	Mono8, BayerRG8
MER-231-41GM/C-P	Mono8, Mono10, BayerRG8, BayerRG10
MER-231-41GM/C	Mono8, Mono10, BayerRG8, BayerRG10
MER-232-48GM-P NIR	Mono8, Mono10
MER-500-14GM/C-P	Mono8, Mono10, BayerGR8, BayerGR10
MER-500-14GM/C	Mono8, Mono10, BayerGR8, BayerGR10
MER-503-20GM/C	Mono8, Mono10, BayerRG8, BayerRG10
MER-503-20GM/C-P	Mono8, Mono10, BayerRG8, BayerRG10
MER-504-10GM/C-P	Mono8, Mono12, BayerRG8, BayerRG12
MER-530-20GM-P NIR	Mono8, Mono10
MER-531-20GM/C-P	Mono8, Mono10, BayerRG8, BayerRG10
MER-630-16GM/C-P	Mono8, Mono12, BayerRG8, BayerRG12
MER-630-16GM/C	Mono8, Mono12, BayerRG8, BayerRG12

MER-1070-10GM/C-P	Mono8, Mono12, BayerGR8, BayerGR12
MER-1070-10GM/C	Mono8, Mono12, BayerGR8, BayerGR12
MER-1220-9GM/C-P	Mono8, Mono12, BayerRG8, BayerRG12
MER-1220-9GM/C	Mono8, Mono12, BayerRG8, BayerRG12
MER-1520-7GC-P	BayerGR8, BayerGR12
MER-1520-7GC	BayerGR8, BayerGR12
MER-2000-5GM/C-P	Mono8, Mono12, BayerRG8, BayerRG12
MER-2000-5GM/C	Mono8, Mono12, BayerRG8, BayerRG12

Table 8-4 Pixel format that the MER-G-P/MER-G series camera supported

The image data starts from the upper left corner, and each pixel is output brightness value of each pixel line from left to right and from top to bottom.

- Mono8

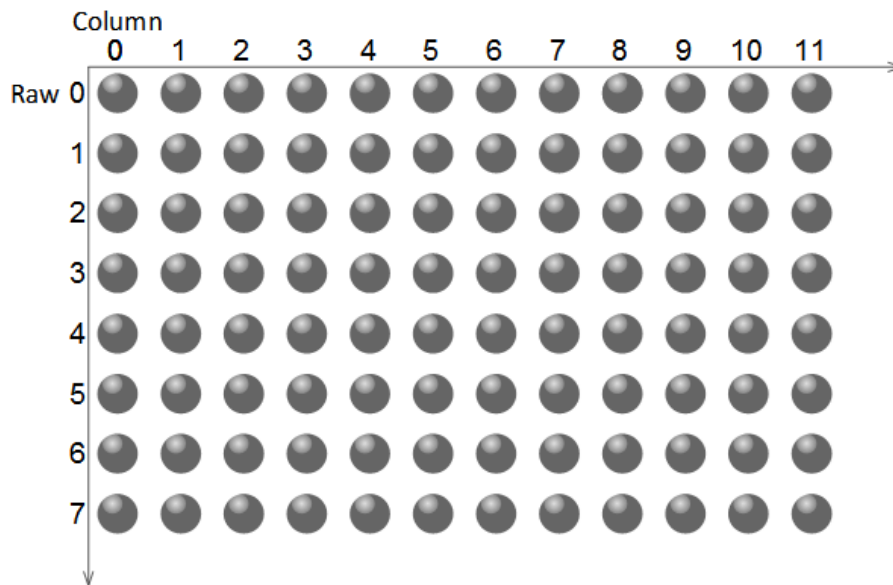

When the pixel format is set to Mono8, the brightness value of each pixel is 8 bits. The format in the memory is as follows:

Y00	Y01	Y02	Y03	Y04
Y10	Y11	Y12	Y13	Y14
.....					

Among them Y00, Y01, Y02 ... are the gray value of each pixel that starts from the first row of the image. Then the gray value of the second row pixels of the images is Y10, Y11, and Y12...

● **Mono10/Mono12**

When the pixel format is set to mono10 or Mono12, each pixel is 16 bits. When Mono10 is selected, the effective data is only 10 bits, the six unused most significant bits are filled with zero. When Mono12 is selected, the effective data is only 12 bits, the 4 of the MSB 16 bits data are set to zero. Note that the brightness value of each pixel contains two bytes, arranged in little-endian mode. The format is as follows:

Y00	Y01	Y02	Y03	Y04
Y10	Y11	Y12	Y13	Y14
.....					

Among them Y00, Y01, Y02...are the gray value of each pixel that start with the first row of the image. The first byte of each pixel is low 8 bits of brightness, and the second byte of each pixel is high 8 bits of brightness.

● **BayerRG8**

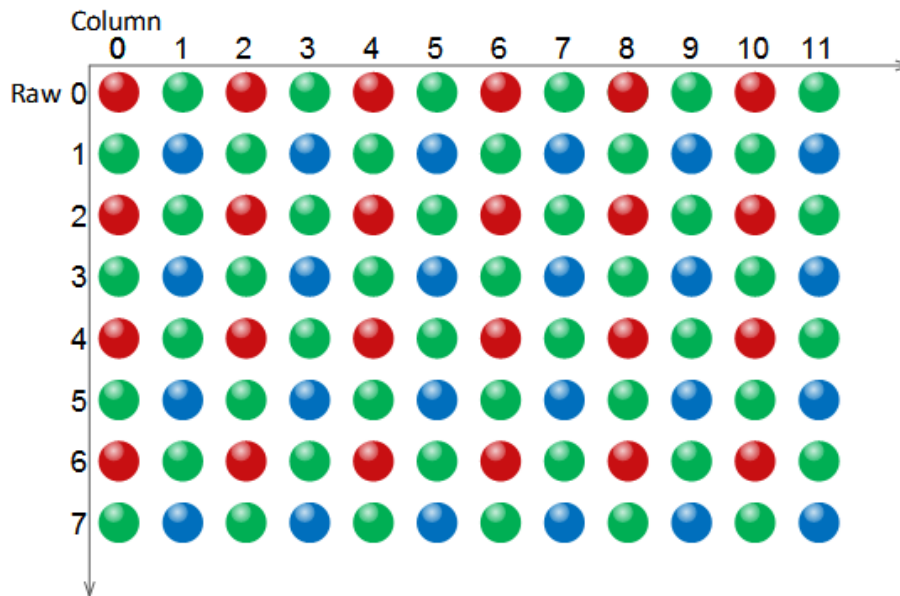

When the pixel format is set to BayerRG8, the value of each pixel in the output image of the camera is 8 bits. According to the location difference, the three components of red, green and blue are respectively represented. The format in the memory is as follows:

R00	G01	R02	G03	R04
G10	B11	G12	B13	G14
.....					

Where R00 is the first pixel value of the first row (for the red component), G01 represents the second pixel value (for the green component), and so on, so that the first row pixel values are arranged. G10 is the first pixel value of the second row (for the green component), the B11 is the second pixel value (for the blue component), and so on, and the second row of pixel values are arranged.

● **BayerRG10/BayerRG12**

When the pixel format is set to BayerRG10 or BayerRG12, the value of each pixel in the output image of the camera is 16 bits. According to the location difference, the three components of red, green and blue are respectively represented. The format in the memory is as follows:

R00	G01	R02	G03	R04
G10	B11	G12	B13	G14
.....					

Each pixel is the same as BayerRG8, the difference is that each pixel is made up of two bytes, the first byte is the low 8 bits of the pixel value, and the second byte is the high 8 bits of the pixel value.

● **BayerGR8**

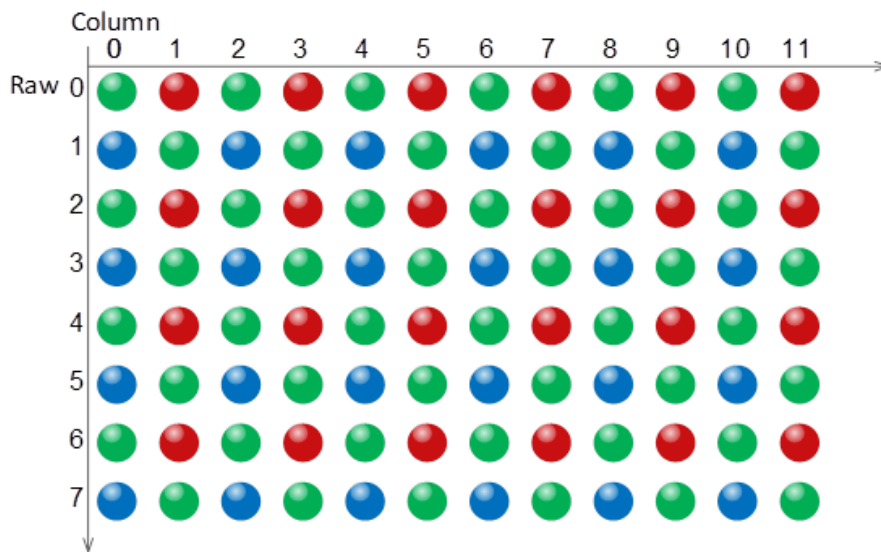

When the pixel format is set to BayerGR8, the value of each pixel in the output image of the camera is 8 bits. According to the location difference, the three components of red, green and blue are respectively represented. The format in the memory is as follows:

G00	R01	G02	R03	G04
B10	G11	B12	G13	B14
.....					

Where G00 is the first pixel value of the first row (for the green component), R01 represents the second pixel value (for the red component), and so on, so that the first row pixel values are arranged. B10 is the first pixel value of the second row (for the blue component), the G11 is the second pixel value (for the green component), and so on, and the second row of pixel values are arranged.

● **BayerGR10/BayerGR12**

When the pixel format is set to BayerGR10 or BayerGR12, the value of each pixel in the output image of the camera is 16 bits. According to the location difference, the three components of red, green and blue are respectively represented. The format in the memory is as follows:

G00	R01	G02	R03	G04
B10	G11	B12	G13	B14
.....					

Each pixel is the same as BayerGR8, the difference is that each pixel is made up of two bytes, the first byte is the low 8 bits of the pixel value, and the second byte is the high 8 bits of the pixel value.

8.3.3. ROI

By setting the ROI of the image, the camera can transmit the specific region of the image, and the output region's parameters include OffsetX, OffsetY, width and height of the output image. The camera only reads the image data from the sensor's designated region to the memory, and transfer it to the host, and the other regions' image of the sensor will be discarded.

By default, the image ROI of the camera is the full resolution region of the sensor. By changing the OffsetX, OffsetY, width and height, the location and size of the image ROI can be changed. The OffsetX refers to the starting column of the ROI, and the OffsetY refers to the starting row of the ROI.

The coordinates of the ROI of the image are defined the 0th line and 0th columns as the origin of the upper left corner of the sensor. As shown in the figure, the OffsetX of the ROI is 4, the OffsetY is 4, the height is 8 and the width is 12.

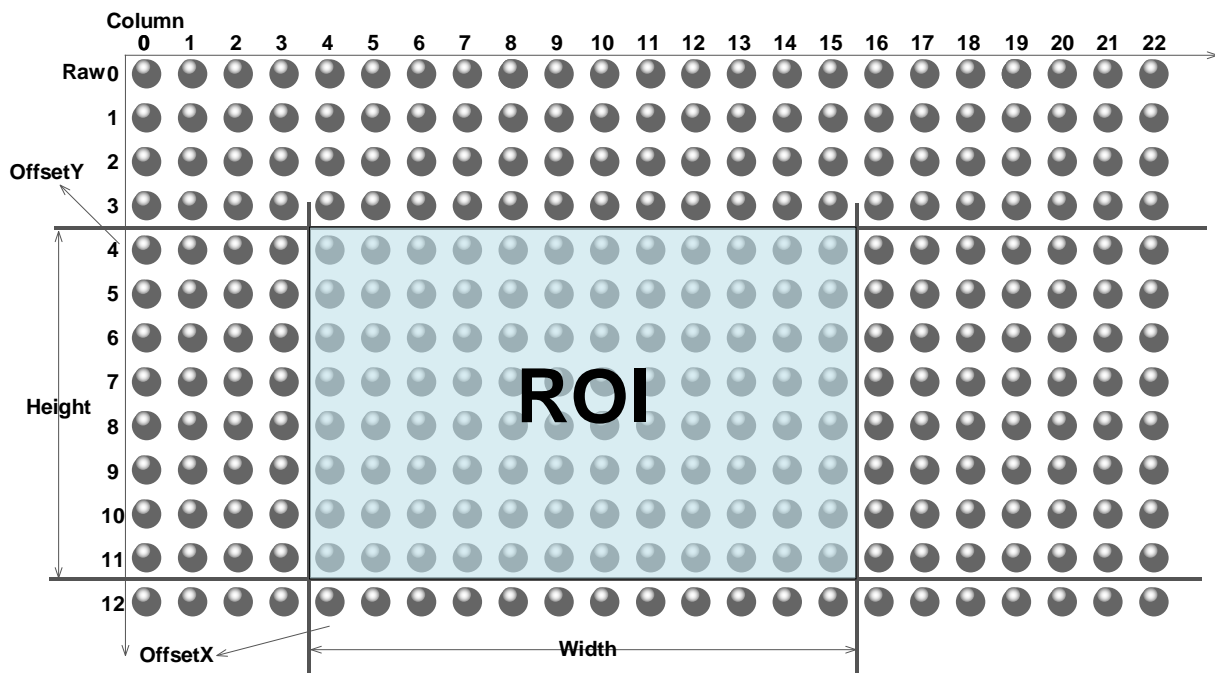

When reducing the height of the ROI, the maximum frame rate of the camera will be raised. Please refer to section 8.5.1 for specific effects on the acquisition frame rate.

8.3.4. Auto Exposure/Auto Gain

8.3.4.1. ROI Setting of Auto Exposure/ Auto Gain

For Auto Exposure and Auto Gain, you can specify a portion of the sensor array and only the pixel data from the specified portion will be used for auto function control.

AAROI is defined by the following way:

AAROIOffsetX: The offset of the X axis direction.

AAROIOffsetY: The offset of the Y axis direction.

AAROIWidth: The width of ROI.

AAROIHeight: The height of ROI.

Offset is the offset value that relative to the upper left corner of the image. The step of AAROIOffsetX and AAROIWidth is 4. The step of AAROIOffsetY and AAROIHeight is 2. The setting of the AAROI depends on the size of the current image and cannot exceed the range of the current image. That is to say, assuming the Width and Height are parameters for users captured image, then the AAROI setting need to meet the condition 1:

$$\text{AAROIWidth} + \text{AAROIOffsetX} \leq \text{Width}$$

$$\text{AAROIHeight} + \text{AAROIOffsetY} \leq \text{Height}$$

If condition 1 is not met, the user cannot set the ROI.

The default value of ROI is the entire image, you can set the ROI according to your need. Where the minimum value of AAROIWidth can be set to 16, and the maximum value is equal to the current image width. The minimum value of AAROIHeight can be set to 16, and the maximum value is equal to the current image height, they are all need to meet the condition1.

For example: the current image width is 1024, the height is 1000, and then the ROI setting is:

$$\text{AAROIOffsetX} = 100$$

$$\text{AAROIOffsetY} = 50$$

$$\text{AAROIWidth} = 640$$

$$\text{AAROIHeight} = 480$$

The relative position of the ROI and the image is shown in Figure 8-19.

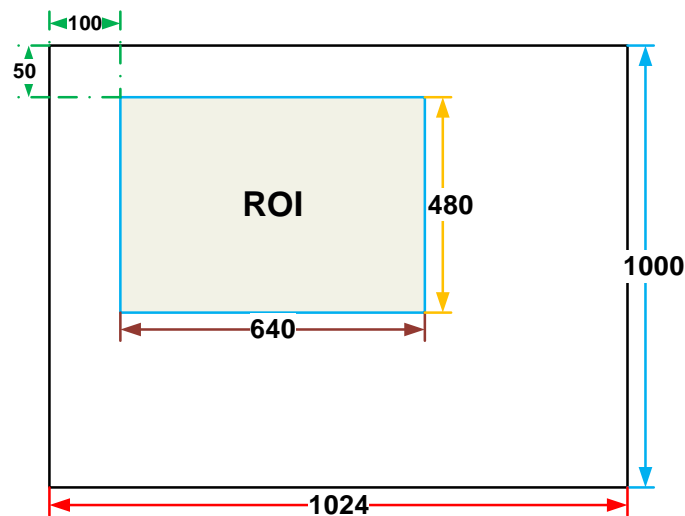

Figure 8-19 An example for the relative position between the ROI and the current image

8.3.4.2. Auto Gain

The auto gain can adjust the camera's gain automatically, so that the average gray value in AAROI is achieved to the expected gray value. The auto gain can be controlled by "Once" and "Continuous" mode.

When using the "Once" mode, the camera adjusts the image data in the AAROI to the expected gray value once, then the camera will turn off the auto gain feature. When using the "Continuous" mode, the camera will continuous adjust the gain value according to the data of the AAROI, so that the data in the AAROI is kept near to the expected gray level.

The expected gray value is set by the user, and it is related to the data bit depth. For 8bit pixel data, the expected gray value range is 0-255, for 10bit pixel data, the expected gray value range is 0-1023, and for 12bit pixel data, the expected gray value range is 0-4095.

The camera adjusts the gain value within the range [minimum gain value, maximum gain value] which is set by the user.

The auto gain feature can be used with the auto exposure at the same time, when target grey is changed from dark to bright, the auto exposure adjust is prior to auto gain adjust. Vice versa, when target grey is changed from bright to dark, the auto gain adjust is prior to auto exposure adjust.

8.3.4.3. Auto Exposure

The auto exposure can adjust the camera's exposure time automatically, so that the average gray value in AAROI can achieve to the expected gray value. The auto exposure can be controlled by "Once" and "Continuous" mode.

When using the "Once" mode, the camera adjusts the image data in the AAROI to the expected gray value once, then the camera will close the auto exposure feature. When using the "Continuous" mode, the camera will continuous adjusting the exposure time according to the data of the AAROI, so that the data in the ROI is kept near to the expected gray level.

The expected gray value is set by the user and it is related to the data bit depth. For 8bit pixel data, the expected gray value range is 0-255, and for 12bit pixel data, the expected gray value range is 0-4095.

The camera adjusts the exposure time in the range [minimum exposure time, maximum exposure time] which is set by the user.

The auto exposure feature can be used with the auto gain at the same time, when target grey is changed from dark to bright, the auto exposure adjust is prior to auto gain adjust. Vice versa, when target grey is changed from bright to dark, the auto gain adjust is prior to auto exposure adjust.

8.3.5. Auto White Balance

8.3.5.1. Auto White Balance ROI

Auto White Balance feature use the image data from AWBROI to calculate the white balance ratio, and then balance ratio is used to adjust the components of the image.

ROI is defined in the following way:

AWBROIOffsetX: The offset of the X axis direction.

AWBROIOffsetY: The offset of the Y axis direction.

AWBROIWidth: The width of ROI.

AWBROIHeight: The height of ROI.

Offset is the offset value that relative to the upper left corner of the image. Where the step length of X axis direction offset and width is 4, the step length of Y axis direction offset and height is 2. The ROI setting depends on the current image and cannot exceed the current image range. Assuming the current image width is Width, the image height is Height, then the ROI setting need to meet the following condition 2:

$$AWBROIWidth + AWBROIOffsetX \leq Width$$

$$AWBROIHeight + AWBROIOffsetY \leq Height$$

If condition 2 is not met, the user cannot set the ROI.

The default value of ROI is the entire image, you can set the "white dot" area (ROI) according to your need. Where the minimum value of AWBROIWidth can be set is 16, the maximum value is equal to the current image width. The minimum value of AWBROIHeight can be set is 16, the maximum value is equal to the current image height, they are all need to meet the condition 2.

Assuming the current image width is 1024, the height is 1000, and then the "white dot" area ROI setting is:

$$AWBROIOffsetX = 100$$

$$AWBROIOffsetY = 50$$

$$AWBROIWidth = 640$$

$$AWBROIHeight = 480$$

The relative position of the ROI and the image is shown in Figure 8-20.

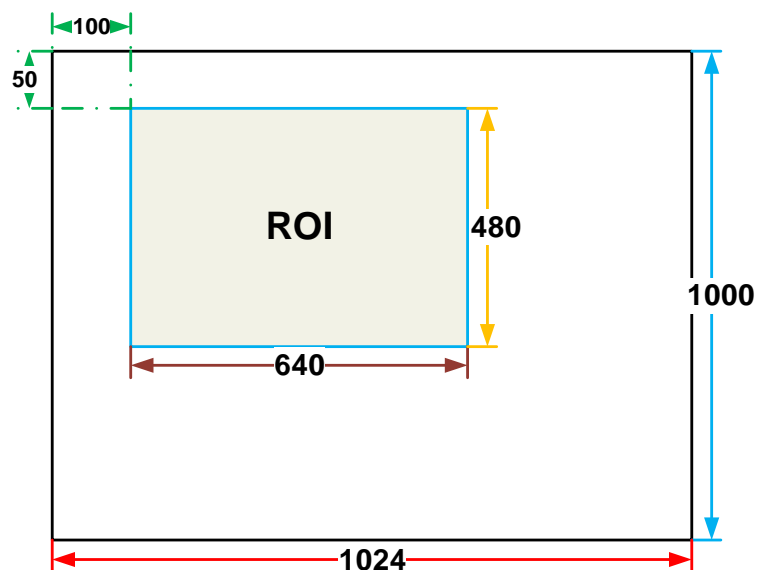

Figure 8-20 An example for the relative position between the ROI and the current image

8.3.5.2. Auto White Balance Adjustment

The auto white balance can be set to "Once" or "Continuous" mode. When using the "Once" mode, the camera just adjusts the white balance ratio only once, when using the "Continuous" mode, the camera continuously adjusts the white balance ratio based on the data in AWBROI.

The auto white balance feature can also select the color temperature. When the color temperature of the selection is "Adaptive", the data in ROI always adjusting the red, green and blue to the same. When selecting the specific color temperature, the camera adjusts the factor according to the light source, so that the hue of the ROI is the same as the hue of the light source. That is: high temperature is cold, low color temperature is warm.

The auto white balance feature is only available on color sensors.

8.3.6. Lookup Table

When the analog signal that is read out by the sensor has been converted via ADC, Generally, the raw data bit depth is larger than 8bits, there are 14bit, 12bit, 10bit or etc. When selecting the output data bit depth is 8bit, you should convert the 12bit data to 8bit data. The lookup table can implement the mapping from 12bit to 8bit.

The lookup table can be a linear lookup table or a non-linear lookup table. The typical linear lookup table implements the selection of 8 bits, and Figure 8-21 is an example of the linear lookup table choosing different 8bits.

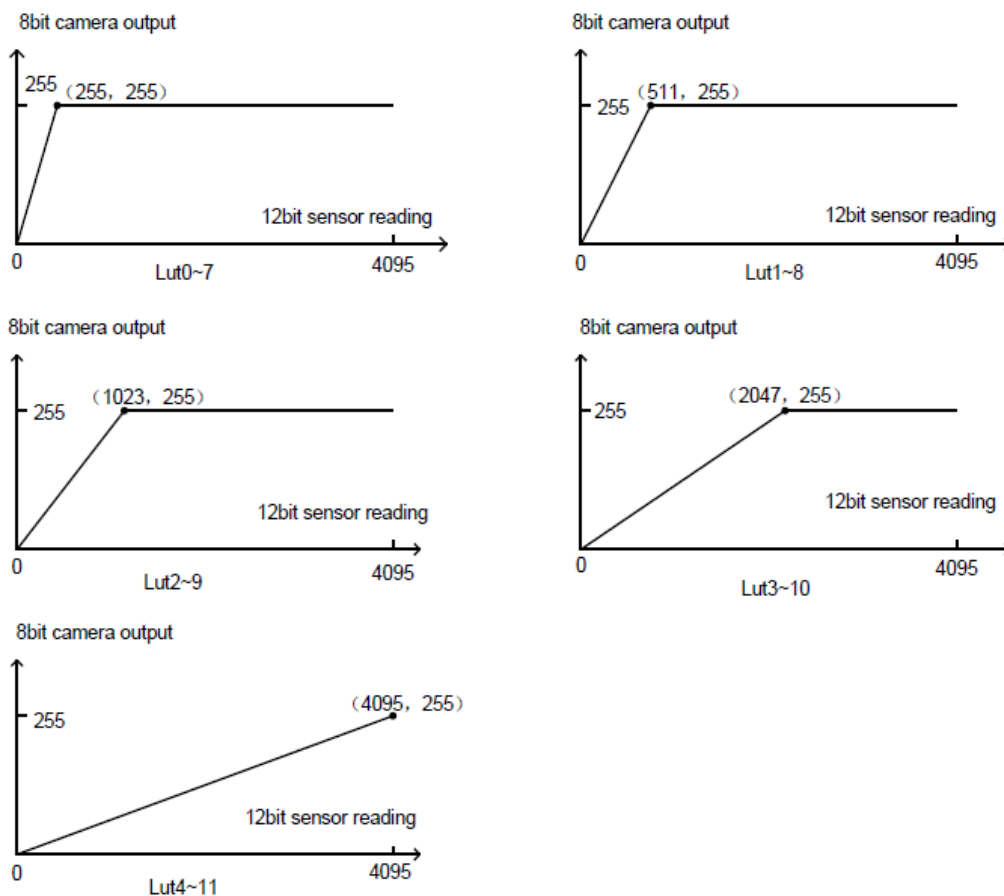

Figure 8-21 Linear lookup table

As shown in the Figure 8-21, the 4-11, 3-10, ... , 0-7 represents the data bits which is selected, and 4-11 is the high 8 bits of 12 bits data. The curvature of the curve increases by a multiple of 2, and the brightness of the image increases with a multiple of 2, at the same time the noise increases.

Non-linear lookup table such as gamma, contrast, brightness, etc., the lookup table tool can produce this type of lookup table. The user can also create a lookup table by dragging the curve according to his own requirements. Figure 8-22 is an example of a non-linear curve.

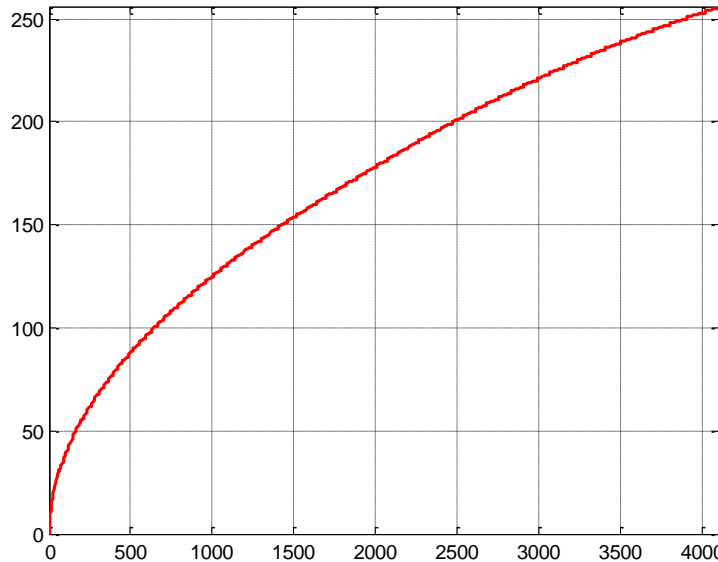

Figure 8-22 Non-linear lookup table

8.3.7. Test Pattern

The MER-G-P/MER-G series camera supports three test images: gray gradient test image, moving horizontal gray gradient test image, and moving diagonal gray gradient test image. When the camera captures in Raw12 mode, the gray value of test image is: the pixel gray value in Raw8 mode multiplies by 16, as the output of pixel gray value in Raw12 mode.

The following three test images are illustrated in the RAW8 mode.

- **GrayFrameRampMoving**

In the gray gradient test image, all the pixels' gray values are the same in the frame. In the adjacent frame, the gray value of the next frame increases by 1 compared to the previous frame, until to 255, and then the next frame gray value returns to 0, and so on. A printscreen of a single frame is shown in Figure 8-23:



Figure 8-23 Gray gradient test image

● **Moving horizontal gray gradient test image**

In the moving horizontal gray gradient test image, the gray value of pixels in each column of the image are equal, each pixel in each row increases by 1, from left to right, until the gray value is 255, then the next gray value returns to 0.

In the moving horizontal gray gradient test image, in the adjacent frame, the first column gray value of the next frame increases by 1 compared to the previous frame. So, in the dynamic image, the image is scrolling to the left. A printscreen of the moving horizontal gray gradient test image is shown in Figure 8-23:

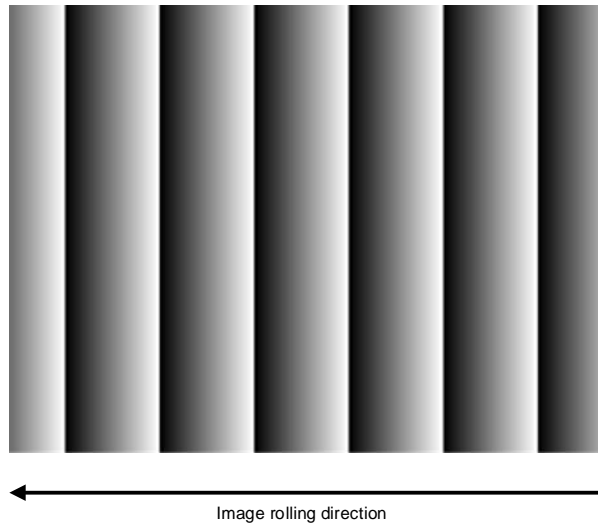

Figure 8-24 Moving horizontal gray gradient test image

● **SlantLineMoving**

In the moving diagonal gray gradient test image, the first pixel value of adjacent row in each frame increases by 1, until the last row. When the pixel gray value increases to 255, the next pixel gray value returns to 0. The first pixel gray value of adjacent column increases by 1, until the last column. When the pixel gray value increases to 255, the next pixel gray value returns to 0.

In the moving diagonal gray gradient test image, in the adjacent frame, the first pixel gray value of the next frame increases by 1 compared to the previous frame. So, in the dynamic image, the image is scrolling to the left. A printscreen of the moving diagonal gray gradient test image is shown in Figure 8-25:

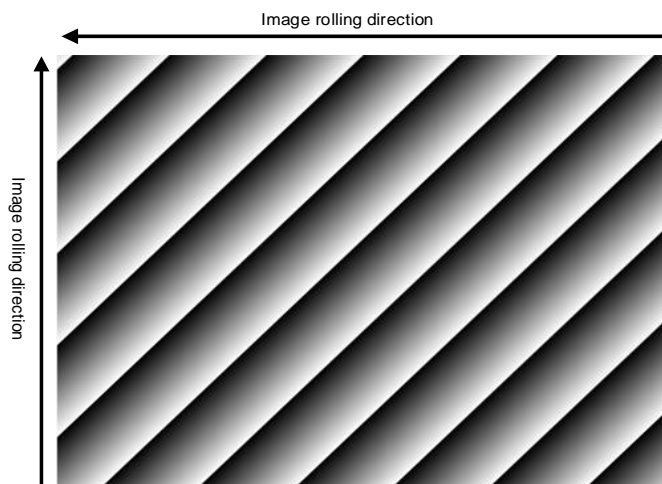

Figure 8-25 Moving diagonal gray gradient test image

8.3.8. User Set Control

By setting various parameters of the camera, the camera can perform the best performance in different environments. There are two ways to set parameters: one is to modify the parameters manually, and the other is to load parameter set. In order to save the specific parameters of the users, avoiding to set the parameters every time when you open the camera, the MER-G-P/MER-G series camera provides a function to save the parameter set, which can easily save the parameters that the user use, including the control parameters that the camera needed. There three types of configuration parameters: the currently effective configuration parameters, the vendor default configuration parameters (Default), and the user configuration parameters (UserSet).

Three operations can be performed on the configuration parameters, including save parameters (UserSetSave), load parameters (UserSetLoad), and set the startup parameter set (UserSetDefault). The UserSetSave is to save the effective configuration parameters to the user configuration parameter set which is set by the user. The UserSetLoad is to load the vendor default configuration parameters (Default) or the user configuration parameters (UserSet) to the current effective configuration parameters. The UserSetDefault is refer to the user can specify a set of parameters which to be loaded into the effective configuration parameters automatically when the camera is reset or powered on. And the camera can work under this set of parameters. This set of parameters can be vendor default configuration parameters or user configuration parameters.

1) The type of configuration parameters

The type of configuration parameters includes: the current effective configuration parameters, vendor default configuration parameters, user configuration parameters.

The current effective configuration parameters: Refers to the current control parameters used by the camera. Using API function or Demo program to modify the current control parameters of the camera is to modify the effective configuration parameters. The effective parameters are stored in volatile memory of the camera, so when the camera is reset or powered on again, the effective configuration parameters will be lost.

The vendor default configuration parameters (Default): Before the camera leaves the factory, the camera manufacturer will test the camera to assess the camera's performance and optimize the configuration parameters of the camera. The manufacturer's default configuration parameters are the camera configuration parameters optimized by the manufacture in a particular environment, these parameters are stored in the non-volatile memory of the camera, so when the camera is reset or powered on again, the effective configuration parameters will not be lost, and these parameters cannot be modified.

The user configuration parameters (UserSet): The effective parameters are stored in volatile memory of the camera, so when the camera is reset or powered on again, the effective configuration parameters will be lost. You can store the effective configuration parameters to the user configuration parameters, the user configuration parameters are stored in the non-volatile memory of the camera, so when the camera is reset or powered on again, the user configuration parameters will not be lost. The MER-G-P/MER-G series camera can store a set of user configuration parameters.

2) The operation of configuration parameters

The operations for configuration parameters include the following three types: save parameters, load parameters and set the UserSetDefault.

Save parameters (UserSetSave): Save the current effective configuration parameters to the user configuration parameters. The storage steps are as follows:

- 1) Modify the camera's configuration parameters, until the camera runs to the user's requirements.
- 2) Use UserSetSelector to select UserSet0. Execute UserSetSave command.

The camera's configuration parameters which are saved in the user parameter set include:

- Gain
- ExposureTime
- TransferControlMode
- PixelFormat
- OffsetX, OffsetY, ImageWidth, ImageHeight
- GevSCPSPacketSize, GevSCPD
- EventNotification
- TriggerMode, TriggerSource, TriggerPolarity, TriggerDelay
- TriggerFilterRaisingEdge, TriggerFilterFallingEdge
- LineMode, LineInverter, LineSource, UserOutputValue
- FrameBufferOverwriteActive
- ChunkModeActive
- TestPattern
- ExpectedGrayValue
- ExposureAuto, AutoExposureTimeMax, AutoExposureTimeMin
- GainAuto, AutoGainMax, AutoGainMin
- AAROIOffsetX, AAROIOffsetY, AAROIWidth, AAROIHeight
- BalanceWhiteAuto, AWBLampHouse
- AWBROIOffsetX, AWBROIOffsetY, AWBROIWidth, AWBROIHeight
- BalanceRatio(R/G/B)
- LUT

Load parameters (UserSetLoad): Load the vendor default configuration parameters or the user configuration parameters into the effective configuration parameters. After this operation is performed, the

effective configuration parameters will be covered by the loaded parameters which are selected by the user, and the new effective configuration parameters are generated. The operation steps are as follows:

- 1) Use UserSetSelector to select Default or UserSet0.
- 2) Execute UserSetLoad command to load the User Set specified by UserSetSelector to the device and makes it active.

Change startup parameter set (UserSetDefault): The user can use UserSetDefault to select Default or UserSet0 as the UserSetDefault. When the camera is reset or powered on again, the parameters in the UserSetDefault will be loaded into the effective configuration parameters.

8.3.9. Device User ID

The MER-G-P/MER-G series camera provides programmable device user ID function, the user can set a unique identification for the camera, and can open and control the camera by the unique identification.

The user-defined name is a string which maximum length is 16 bytes, the user can set it by the following ways:

- 1) Set by the **IP Configurator**, for details please see section 9.1.2.5:

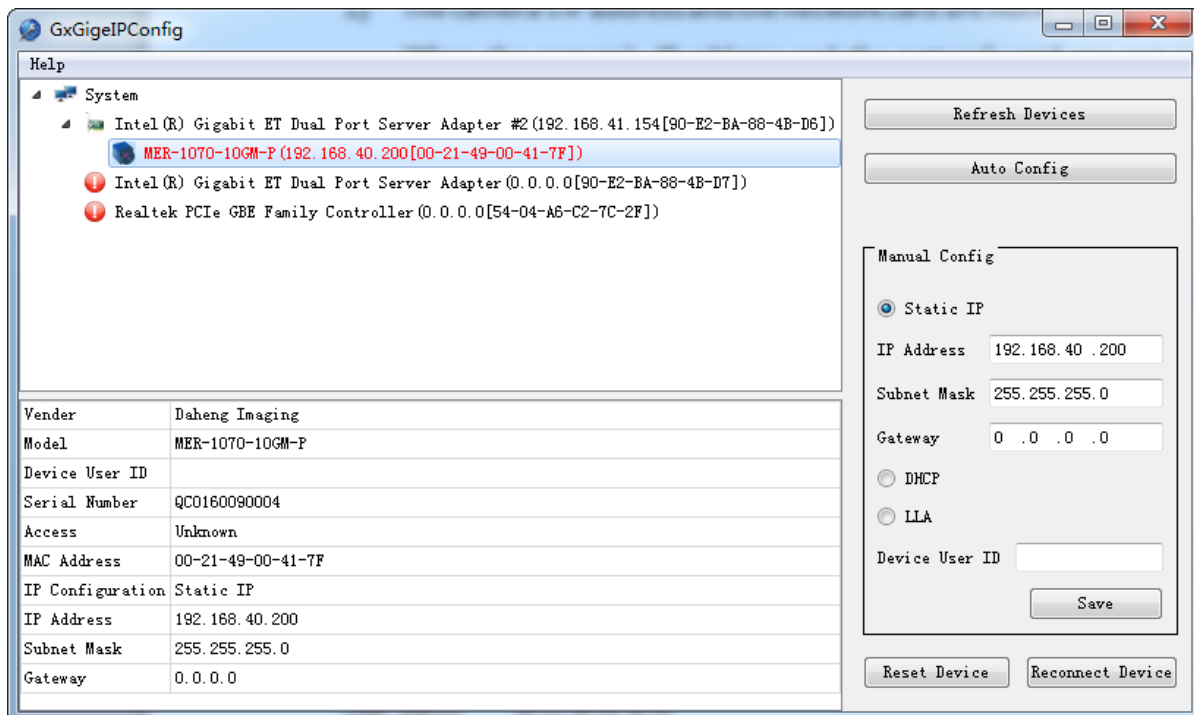

Figure 8-26 IP Configurator

- 2) Set by calling the software interface, for details please see the Programmer's Guide.



When using multi-cameras at the same time, it is necessary to ensure the uniqueness of the user-defined name of each camera, otherwise, an exception will occur when the camera is opened.

8.4. Image Processing

8.4.1. HDR

HDR stands for “high dynamic range”. For industrial cameras, it means that the camera directly generates high dynamic range digital images. In contrast, acquiring images using traditional methods is called LDR (low dynamic range).

The dynamic range of an image (ie, contrast) is the ratio of light to dark. In other words, if the image contains both brighter and darker areas, the dynamic range is higher (e.g., an image of a person stands with his back to the sun). If the dynamic range is extremely small, the brightness can also be high because there is no darker area (e.g., facing the sun).

The HDR mode acquires two images at different exposures. Long-exposure image and short-exposure image merged into one HDR image. The HDR image retains both dark details in the high-brightness image and the bright details in the low-brightness image.

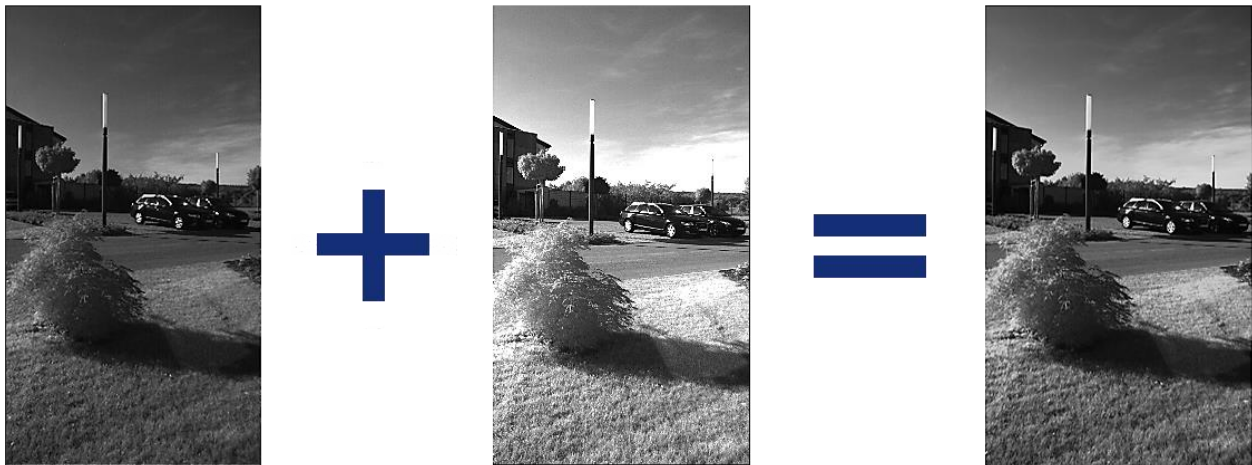

Figure 8-27 HDR diagram

Camera model that support this feature:

Model
MER-203-30GC-P-L
MER-203-30GC-P-L-F03
MER-204-30GC-P-L-F02

8.5. Image Transmission

8.5.1. Maximum Allowable Frame Rate

- 1) The maximum allowable frame rate of the network

The maximum allowable frame rate of the network is the camera's maximum transmission frame rate that the current network supports. The maximum frame rate that the MER-G-P/MER-G series camera network

supports is determined by the camera's resolution, pixel format (Pixel Size), and the valid network bandwidth. It can be expressed by the formula:

The maximum allowable frame rate of the network = the valid network bandwidth/ resolution/ Pixel Size

Example 1: The camera resolution is 1628*1236, the pixel format is BayerRG8, packet size is 1500 bytes, and packet delay is 1000. The current valid network bandwidth is 468Mbps.

The maximum allowable frame rate of the network = 468Mbps / (1628*1236)/8 = 29 fps

The maximum allowable frame rate of the network is 29fps, for MER-200-20GM/C-P camera, it can meet the front-end sensor's requirement that the acquisition frame rate is 20fps. In addition to the limitations of network bandwidth, the maximum working frame rate of the camera is affected by the following two factors:

- The camera front-end sensor readout time and the camera internal transfer time is called the camera acquisition time. The camera acquisition time is affected by the ROI which is set by the user
- The camera's exposure time

2) The calculation of the camera's acquisition time

The camera's acquisition time is related to the OffsetY and the height of the ROI. When the OffsetY and height of the ROI is changed, it will affect the front-end acquisition frame period of the camera, then affect the acquisition frame rate.

The specific calculation formulas are as follows:

- MER-030-120GM/C(-P)

Row period (unit: μs):

$$T_{row} = \frac{780}{48} = 16.25$$

Camera acquisition time (unit: μs):

$$T_{acq} = \left(\text{int} \left(\frac{512 - (\text{height} + \text{offsety} + 8)}{8} \right) + \text{int} \left(\frac{\text{offsety} + 8}{8} \right) + (\text{offsety} + 8) - \left(\left(\text{int} \left(\frac{\text{offsety} + 8}{8} \right) - 1 \right) * 8 \right) \right) + (\text{height} + 1) * T_{row}$$

- MER-031-300GM/C(-P) (NIR)

Row period (unit: μs):

$$T_{row} = \frac{78 + \text{width}/4}{36}$$

Camera acquisition time (unit: μs):

$$T_{acq} = \text{height} * T_{row} + 165$$

- MER-032-120GM/C(-P)

Row period (unit: μs):

$$T_{row} = \frac{990}{60} = 16.5$$

Camera acquisition time (unit: μs):

$$T_{\text{acq}} = \left(\text{int} \left(\frac{504 - (\text{height} + \text{offsety} + 4)}{4} \right) + \text{int} \left(\frac{\text{offsety} + 4}{4} \right) + (\text{offsety} + 4) - \left(\left(\text{int} \left(\frac{\text{offsety} + 4}{4} \right) - 1 \right) * 4 \right) \right) + (\text{height} + 1) * T_{\text{row}}$$

- MER-041-302GM/C(-P)

Row period (unit: μs):

$$T_{\text{row}} = \frac{198}{37.5} = 5.28$$

Camera acquisition time (unit: μs):

$$T_{\text{acq}} = (\text{height} + 71) * T_{\text{row}}$$

- MER-050-200GM/C(-P) (NIR)

Row period (unit: μs):

$$T_{\text{row}} = \frac{78 + \text{width}/4}{36}$$

Camera acquisition time (unit: μs):

$$T_{\text{acq}} = \text{height} * T_{\text{row}} + 165$$

- MER-051-120GM/C(-P)

Row period (unit: μs):

$$T_{\text{row}} = \frac{(78 + \text{width}) * 1000}{68}$$

Camera acquisition time (unit: μs):

$$T_{\text{acq}} = (\text{height} * T_{\text{row}} + 413222)/1000$$

- MER-125-30GM/C(-P)

Row period (unit: μs):

$$T_{\text{row}} = \frac{1600}{48} \approx 33.33$$

Camera acquisition time (unit: μs):

$$T_{\text{acq}} = \left(\text{int} \left(\frac{980 - (\text{height} + \text{offsety} + 8)}{8} \right) + \text{int} \left(\frac{\text{offsety} + 8}{8} \right) + (\text{offsety} + 8) - \left(\left(\text{int} \left(\frac{\text{offsety} + 8}{8} \right) - 1 \right) * 4 \right) + (\text{height} + 1) * T_{\text{row}} \right)$$

- MER-130-30GM/C(-P)

Row period (unit: μs):

$$T_{\text{row}} = \frac{1524}{48} \approx 31.75$$

Camera acquisition time (unit: μs):

Continuous acquisition:

$$T_{\text{acq}} = (\text{height} + 26) * T_{\text{row}}$$

Trigger acquisition:

$$T_{\text{acq}} = \left(1524 + \text{ROUNDUP} \left(\frac{\text{ExporeTime} * 48 + 180}{1524} \right) * 1524 + (\text{height} + 8) * 1524 + 1524 + 144 \right) / 48$$

- MER-131-75GM/C(-P) (NIR)

Camera acquisition time (unit: μs):

Pixel format is 8bit:

$$T_{\text{acq}} = ((\text{width} * \text{height} + 36 + 10) / 984) * 10$$

Pixel format is 12bit:

$$T_{\text{acq}} = ((\text{width} * \text{height} * 2 + 36 + 10) / 984) * 10$$

- MER-132-30GM/C

Row period (unit: μs):

$$T_{\text{row}} = \frac{1532}{45} \approx 34.04$$

Camera acquisition time (unit: μs):

$$T_{\text{acq}} = \left(\text{int} \left(\frac{996 - (\text{height} + \text{offsety} + 16)}{8} \right) + \text{int} \left(\frac{\text{offsety} + 16}{8} \right) + (\text{offsety} + 16) - \left(\left(\text{int} \left(\frac{\text{offsety} + 16}{8} \right) - 1 \right) * 8 \right) + \text{height} + 1 \right) * T_{\text{row}}$$

- MER-132-43GM/C(-P)

Row period (unit: μs):

$$T_{\text{row}} = \frac{1532}{65} \approx 23.57$$

Camera acquisition time (unit: μs):

$$T_{\text{acq}} = \left(\text{int} \left(\frac{996 - (\text{height} + \text{offsety} + 16)}{8} \right) + \text{int} \left(\frac{\text{offsety} + 16}{8} \right) + (\text{offsety} + 16) - \left(\left(\text{int} \left(\frac{\text{offsety} + 16}{8} \right) - 1 \right) * 8 \right) + \text{height} + 1 \right) * T_{\text{row}}$$

- MER-133-54GM/C(-P)

Continuous mode, row period (unit: μs):

$$T_{\text{row}} = \frac{1388}{74.25} = 18.69$$

Trigger mode, row period (unit: μs):

$$T_{\text{row}} = \frac{1650}{74.25} = 22.222$$

Camera acquisition time (unit: μs):

$$T_{\text{acq}} = (\text{Height} + 30) * T_{\text{row}}$$

- MER-200-14GM/C

Row period (unit: μs):

$$T_{\text{row}} = \frac{1920}{36} \approx 53.33$$

Camera acquisition time (unit: μs):

$$T_{\text{acq}} = \left(\text{int} \left(\frac{1339 - (\text{height} + \text{offsety} + 10)}{8} \right) - 1 \right) * 8 + \text{height} + 1) * T_{\text{row}} + \text{int} \left(\frac{\text{offsety} + 10}{8} \right) + (\text{offsety} + 10) - \left(\text{int} \left(\frac{\text{offsety} + 10}{8} \right) \right)$$

- MER-200-20GM/C(-P)

Row period (unit: μs):

$$T_{\text{row}} = \frac{1920}{50} \approx 38.4$$

Camera acquisition time (unit: μs):

$$T_{\text{acq}} = \left(\text{int} \left(\frac{1339 - (\text{height} + \text{offsety} + 10)}{8} \right) - 1 \right) * 8 + \text{height} + 1) * T_{\text{row}} + \text{int} \left(\frac{\text{offsety} + 10}{8} \right) + (\text{offsety} + 10) - \left(\text{int} \left(\frac{\text{offsety} + 10}{8} \right) \right)$$

- MER-201-25GM/C(-P)

Row period (unit: μs):

$$T_{\text{row}} = \frac{1911}{60} \approx 31.85$$

Camera acquisition time (unit: μs):

$$T_{\text{acq}} = \left(\text{int} \left(\frac{1256 - (\text{height} + \text{offsety} + 11)}{8} \right) - 1 \right) * 8 + \text{height} + 1) * T_{\text{row}} + \text{int} \left(\frac{\text{offsety} + 11}{8} \right) + (\text{offsety} + 11) - \left(\text{int} \left(\frac{\text{offsety} + 11}{8} \right) \right)$$

- MER-203-30GC-P-L, MER-203-30GC-P-L-F03, MER-204-30GC-P-L-F02

Row period (unit: μs):

$$T_{\text{row}} = \frac{33333.33}{1125} \approx 29.63$$

Camera acquisition time (unit: μs):

$$T_{\text{acq}} = 1125 * T_{\text{row}} = 1000000/30$$

Note: The MER-203-30GC-P-L, MER-203-30GC-P-L-F03 and MER-204-30GC-P-L-F02 camera acquires images at a fixed frame rate. The frame rate is fixed at 30fps and does not change with the width and height of the ROI.

- MER-231-41GM/C(-P)

Row period (unit: μs):

$$T_{\text{row}} = \frac{746}{37.5} \approx 19.89$$

Camera acquisition time (unit: μs):

Pixel format is 8bit:

$$T_{\text{acq}} = (\text{height} + 38) * T_{\text{row}}$$

Pixel format is 12bit:

$$T_{\text{acq}} = (\text{height} + 38) * 2 * T_{\text{row}}$$

- MER-232-48GM/C(-P / NIR)

Row period (unit: μs):

$$T_{\text{row}} = \frac{(\text{width}/2 + 266)}{72}$$

Camera acquisition time (unit: μs):

$$T_{\text{acq}} = \text{height} * T_{\text{row}}$$

- MER-503-20GM/C(-P)

Row period (unit: μs):

$$T_{\text{row}} = \frac{900}{37.5} = 24$$

Camera acquisition time (unit: μs):

Pixel format is 8bit:

$$T_{\text{acq}} = (\text{height} + 32) * T_{\text{row}}$$

Pixel format is 12bit:

$$T_{\text{acq}} = (\text{height} + 32) * 2 * T_{\text{row}}$$

- MER-504-10GM/C-P

Row period (unit: μs):

$$T_{\text{row}} = \frac{3152}{65} \approx 48.49$$

Camera acquisition time (unit: μs):

$$T_{\text{acq}} = \left(\text{int}\left(\frac{2072 - (\text{height} + \text{offsety} + 8)}{4}\right) + \text{int}\left(\frac{\text{offsety} + 8}{4}\right) + (\text{offsety} + 8) - \left(\left(\text{int}\left(\frac{\text{offsety} + 8}{4}\right) - 1\right) * 8\right) + \text{height} + 1 \right) * T_{\text{row}}$$

- MER-500-14GM/C(-P)

Row period (unit: μs):

$$T_{\text{row}} = 20832 * \max\left(\left(\frac{(\text{Width} + 1)}{2} + 450\right), 487\right) * 10^{-6}$$

Camera acquisition time (unit: μs):

$$T_{\text{acq}} = (\text{Height} + 19) * T_{\text{row}}$$

- MER-530-20GM/C(-P / NIR)

Row period (unit: μs):

$$T_{\text{row}} = \frac{\text{width}/2 + 278}{72}$$

Camera acquisition time (unit: μs):

$$T_{\text{acq}} = \text{height} * T_{\text{row}}$$

- MER-531-20GM/C(-P)

Row period (unit: μs):

$$T_{\text{row}} = \frac{\text{width}/2 + 278}{72}$$

Camera acquisition time (unit: μs):

$$T_{\text{acq}} = \text{height} * T_{\text{row}}$$

- MER-630-16GM/C(-P)

Row period (unit: μs):

$$T_{\text{row}} = \frac{1911}{60} = 31.85$$

Camera acquisition time (unit: μs):

$$T_{\text{acq}} = \left(\text{int} \left(\frac{(1256 - (\text{height} + \text{offsety} + 11))}{8} \right) - 1 + \text{int} \left(\frac{(\text{offsety} + 11)}{8} \right) + 1 + (\text{offsety} + 11) \right. \\ \left. - (\text{int} \left(\frac{(\text{offsety} + 11)}{8} \right) - 1) * 8 + \text{height} + 2 \right) * T_{\text{row}}$$

- MER-1070-10GM/C(-P)

Row period (unit: μs):

$$T_{\text{row}} = \frac{5520}{160} \approx 22.36$$

Camera acquisition time (unit: μs):

Pixel format is 8bit:

$$T_{\text{acq}} = (\text{Height} + 148) * T_{\text{row}}$$

Pixel format is 12bit:

$$T_{\text{acq}} = (\text{Height} * 2 + 148) * T_{\text{row}}$$

- MER-1220-9GM/C(-P)

Row period (unit: μs):

$$T_{\text{row}} = \frac{198}{37.5} = 5.28$$

Camera acquisition time (unit: μs):

$$T_{\text{acq}} = (\text{height} + 29 + 42) * T_{\text{row}}$$

● MER-1520-7GM/C(-P)

Row period (unit: μs):

$$T_{\text{row}} = \frac{4920}{220} = 34.5$$

Camera acquisition time (unit: μs):

Pixel format is 8bit:

$$T_{\text{acq}} = (\text{Height} + 3092) * T_{\text{row}}$$

Pixel format is 12bit:

$$T_{\text{acq}} = (\text{Height} * 2 + 3092) * T_{\text{row}}$$

● MER-2000-5GM/C(-P)

Row period (unit: μs):

$$T_{\text{row}} = \frac{2232}{72} = 31$$

Camera acquisition time (unit: μs):

$$T_{\text{acq}} = 33 + (\max(\text{height}, 1848) + 5) * T_{\text{row}}$$

Height > 1848:

$$T_{\text{acq}} = 33 + (\text{height} + 5) * T_{\text{row}}$$

Height < 1848:

$$T_{\text{acq}} = 33 + 1848 * T_{\text{row}}$$

3) The camera's acquisition frame rate

In addition to the maximum allowable bandwidth of the network and the time limit for camera acquisition, the exposure time can also affect the frame rate. For example: for MER-200-20GM/C-P camera, when the exposure time is 100ms, the corresponding frame rate is 10fps.

In conclusion, the frame rate of the camera takes the minimum of the maximum allowable frame rate of the network, the acquisition frame rate and the exposure frame rate.

8.5.2. Stream Channel Packet Size

Stream channel packet size (SCPS) refers to the network packet's size of the stream channel data which is transferred to the host terminal by the camera, in bytes and the default value is 1500. It includes the IP header, UDP header and GVSP header which the total length is 36 bytes, so the payload in the default channel network packet is 1464 bytes. The recommended maximum packet size is 8192 bytes, which can improve the network transmission performance.



- 1) When the packet size is set to more than 1500, it needs the network equipment such as network card and switch to support the jumbo frames.
- 2) When changing the packet size, the packet size and the packet delay will affect the network transfer performance together.

8.5.3. Stream Channel Packet Delay

The stream channel packet delay (SCPD) is used to control the bandwidth of the image streaming data of the camera. The packet delay is the number of the idle clocks that inserted between adjacent network packets transmitted in the stream channel. Increase the packet delay can reduce the camera's bandwidth usage, and it may also reduce the camera's frame rate (the camera frame rate also depends on the exposure time, camera acquisition time).

The camera's packet size, packet delay and reserved bandwidth determine the effective network bandwidth. The effective network bandwidth is calculated as follows.

The time required to transmit a single stream packet:

$$T_{data} = (Size_{pkt} \times 8 \text{ bits}) / Speed_{link}$$

The time of packet delay is:

$$T_{delay} = Delay_{pkt} / 125,000,000$$

Among them: the $Size_{pkt}$ is packet size, $Delay_{pkt}$ is packet delay, $BandW_{reserve}$ is reserved bandwidth, $Speed_{link}$ is link speed.

Effective network bandwidth:

$$BandW_{avial} = (Size_{pkt} \times 8 \text{ bits} \times (1 - BandW_{reserve})) / (T_{data} + T_{delay})$$

Example 1: The packet size is 1500, the packet delay is 1000, the reserved bandwidth is 20%, and the link speed is 1Gbps.

The time to transport a single stream packet is:

$$T_{data} = (1500 \times 8) / 1,000,000,000 = 12us$$

The time of packet delay is:

$$T_{delay} = 1000 / 125,000,000 = 8us$$

The effective network bandwidth is:

$$BandW_{avial} = (1464 \times 8 \times (1 - 0.2)) / (12us + 8us) = 468Mbps$$

Note: Each stream packet contains 36 bytes of network header data, and a packet with the size of 1500 bytes contains only 1464 bytes of valid data.

Example 2: The packet size is 8192, the packet delay is 2000, the reserved bandwidth is 20%, and the link speed is 1Gbps.

The time to transport a single stream packet is:

$$T_{data} = (8192 \times 8) / 1,000,000,000 = 66us$$

The time of packet delay is:

$$T_{delay} = 2000/125,000,000 = 16us$$

The effective network bandwidth is:

$$\text{Band}W_{avial} = (8156 \times 8 \times (1 - 0.2))/(66us + 16us) = 637Mbps$$

8.5.4. Bandwidth Reserve

The Bandwidth Reserve is used to reserve a part of bandwidth for packet retransmission and control data transfer between the camera and the host, and can be used for multiple cameras transmission, to limit the bandwidth allocation of each camera. For example, the network bandwidth is 5Gbps, setting the reserved bandwidth value to 20%, then the bandwidth will be reserved to 1Gbps. When the maximum bandwidth required for transmission is greater than the current bandwidth available, the camera reduces the frame rate to ensure the stability of the transmission.

8.5.5. Frame Transfer Control

When multiple cameras are connected to the host by switches, if trigger these cameras to acquire images at the same time, when transmitting the images, because of the instantaneous bandwidth of the switch is too large, and the storage capacity is limited, data loss will occur. Therefore, the user needs to use frame transfer delay to avoid this problem.

In trigger mode, by setting the Transfer Control Mode as “User Controlled”, when the camera receives software trigger command or hardware trigger signal and completes the image acquisition, the camera will save the images in the frame buffer which is internal the camera, waiting for the host to send the “Acquisition Start” command, the camera will transmit the images to the host. The transmission delay time is determined by the host. When multiple cameras are triggered simultaneously, different transmission delay can be set for each camera to avoid the instantaneous bandwidth of the switch is too large.



The frame transmission delay function is valid only in trigger mode.

8.6. Events

When event notification is set to “on”, the camera can generate an “event” and transmit a related event message to the host whenever a specific situation has occurred. For MER-G-P/MER-G series camera, the camera can generate and transmit events for the following types of situations:

- The camera has ended exposure (ExposureEnd)
- An image block is discarded (BlockDiscard)
- The trigger signal overflow (FrameStartOvertrigger)
- The image frame block is not empty (BlockNotEmpty)
- The event queue is overflow (EventOverrun)

Every event has a corresponding enable status, and in default all the events' enable status are disable.

When using the event function, you need to enable the corresponding event firstly and set the port of the event channel, the timeout of the event retransmission, and the number of times the event resends to the camera. When the retransmission timeout of the event is set to 0, the event sent by the camera will not require the host to return the reply packet. When the port value of the event channel is set to 0, the camera will not send the event to the host. In other cases, the camera needs to receive a host reply package before sending the next event. When the event that the camera sends does not receive the reply packet, the camera will retransmit the event according to the retransmission timeout and retransmission times set.

The effective information contained in each event is shown in Table 8-5:

No.	Event Type	Information
1	ExposureEnd Event	Event ID
		Frame ID
		Timestamp
2	BlockDiscard Event	Event ID
		Timestamp
3	EventOverrun Event	Event ID
		Timestamp
4	FrameStartOvertrigger Event	Event ID
		Frame ID
		Timestamp
5	BlockNotEmpty Event	Event ID
		Timestamp

Table 8-5 The effective information of each event

Among them: the timestamp is the time when the event occurs, and the timer starts when the camera is powered on or reset. The bit width of the timestamp is 64 bits, and the unit is 20ns.

8.6.1. ExposureEnd Event

If the ExposureEnd Event is enabled, when the camera’s sensor has been exposed, the camera sends out an ExposureEnd Event to the host, indicating that the exposure has been completed.

Note: The MER-500-14GM/C-P, MER-500-14GM/C, MER-203-30GC-P-L, MER-203-30GC-P-L-F03 and MER-204-30GC-P-L-F02 cameras do not support this function.

8.6.2. BlockDiscard Event

When the average bandwidth of the write-in data is greater than the average bandwidth of the read-out data, the frame buffer may overflow. If the frame buffer is full and the camera continue to write image data to it, then the new data will overwrite the previous image data which has been in the frame buffer. At this moment, the camera sends an image frame data discarding event to the host, indicating that once image discard event has occurred. So when you read the next frame, the image is not continuous.

Note: The MER-203-30GC-P-L, MER-203-30GC-P-L-F03 and MER-204-30GC-P-L-F02 cameras do not support this function.

8.6.3. BlockNotEmpty Event

When the average bandwidth of the read-in data is greater than the average bandwidth of the readout data, if the frame buffer is not full, and there has image frame data in the frame buffer which has not been send out completely, then before the new image frame is written to the frame buffer, the camera will send a Frame Buffer not Empty Event to the host, indicating that the previous image has not been send out completely when the new image is written in the frame buffer.

Note: The MER-203-30GC-P-L, MER-203-30GC-P-L-F03 and MER-204-30GC-P-L-F02 cameras do not support this function.

8.6.4. FrameStartOvertrigger Event

When the camera receives the hardware trigger signal or software trigger signal, if the front-end sensor is exposing, it will not be able to respond to the new trigger signal, then the camera will send a trigger signal overflow event to the host. Note that if multiple trigger signals are received within a frame period, the camera sends only one trigger signal overflow event.

Note: The MER-500-14GM/C-P, MER-500-14GM/C, MER-203-30GC-P-L, MER-203-30GC-P-L-F03 and MER-204-30GC-P-L-F02 cameras do not support this function.

8.6.5. EventOverrun Event

Inside the camera, there has an event queue which is used for caching events. Usually, the event data packet which is sent to the host only contains one event. When there are multiple events occur simultaneously, or when the event transmission is delay, the user can use event queue inside the camera to cache the events. When an event can be sent, the camera will send all the events cached in the queue, at this time the event data packet which is sent to the host contains multiple events. But if the camera is running in a high frame rate mode, and send a number of events that exceed the camera cache, at this time, if the event queue overflow event is enable, the camera will send an event queue overflow event to the host, and discard all the events in the current cache.

Note: The MER-203-30GC-P-L, MER-203-30GC-P-L-F03 and MER-204-30GC-P-L-F02 cameras do not support this function.

9. Software Tools

9.1. GigE IP Configurator

GxGigeIPConfig.exe is a matching software tool for DAHENG IMAGING's GigE cameras. Users can use this tool to implement the following functions.

- 1) This tool can enumerate all GigE Vision cameras attached to your network.
- 2) This tool can be used to change the IP address and the IP configuration.
- 3) This tool can be used to change the User ID of device.
- 4) This tool can reset device and reconnect device.
 - a) Reset device: The effect is the same as powering Off-On. The program inside the device is reloaded.
 - b) Reconnect device: The effect is the same as closing device using SDK. After this operation, the user can reconnect the device.

9.1.1. GUI

When you start up the GigE IP Configurator, you will see a GUI like the following figure.

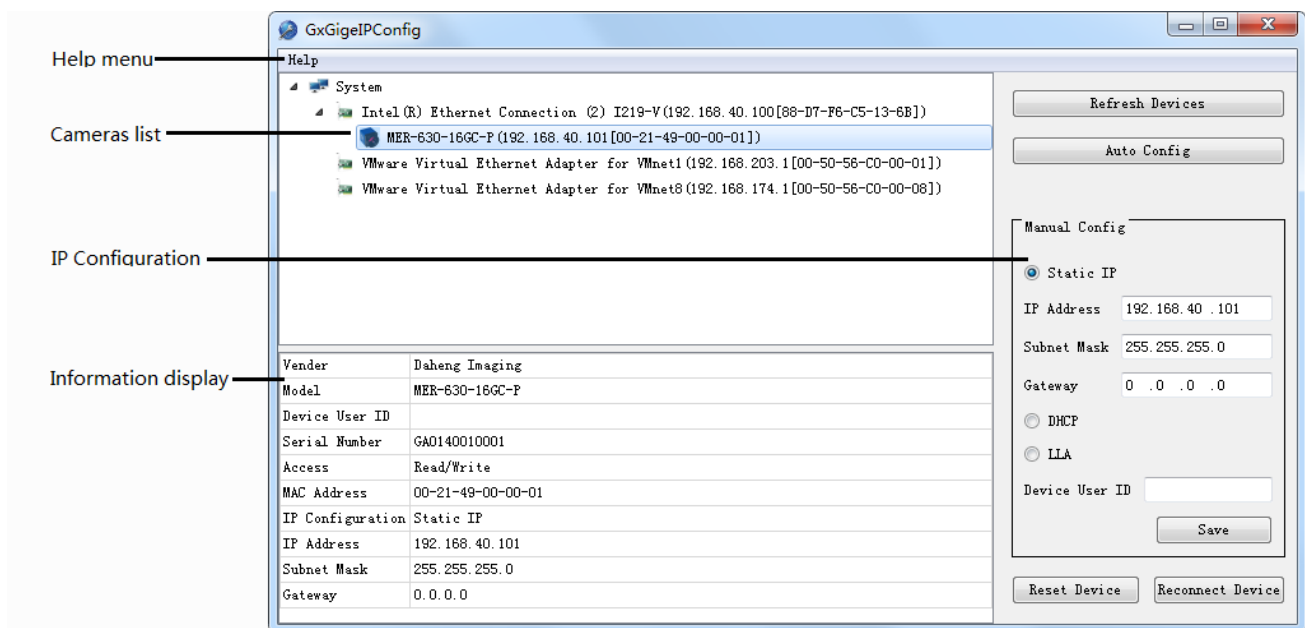

Figure 9-1 GUI

[Help menu] Display the version and copyright of the GigE IP Configurator

[Cameras list] List all GigE Vision enumerated cameras

[Information display] It will display the information of selected feature which can be a camera or a network card. When the tree list root feature is selected, the information display window is empty

[Refresh Devices] Update the network adapters list and the cameras list

[Auto Config] Configure the IP address of the current network card and all the devices under it. When no network card is selected, all device IPs under the network card are configured

[Static IP] If this item is selected, it will use this static IP address

[DHCP] If this item is selected, the camera is configured to use a Dynamic Host Configuration Protocol (DHCP) server to obtain an IP address

[LLA] If this item is selected, the camera will assign itself an Auto IP address (LLA, Link-Local Address), and the Auto IP address ranges from 169.254.0.1 to 169.254.255.254

[Device User ID] The user-defined identity for camera settings and the content is a character string

[Save] Select the **Save** button, the tool will save the current configuration to the selected camera which takes a few seconds

[Reset Device] The effect is the same as powering Off-On. The program inside the device is reloaded

[Reconnect Device] The effect is the same as closing device using SDK. After this operation, the user can reconnect the device

9.1.2. User Guide

9.1.2.1. Refresh Devices

If you click **Refresh Devices**, the tool will update the displayed network adapter and camera information. This way you can make sure that all displayed information is up to date. It will take one second to refresh devices, and during this period, all the buttons are disabled as the following figure shows.

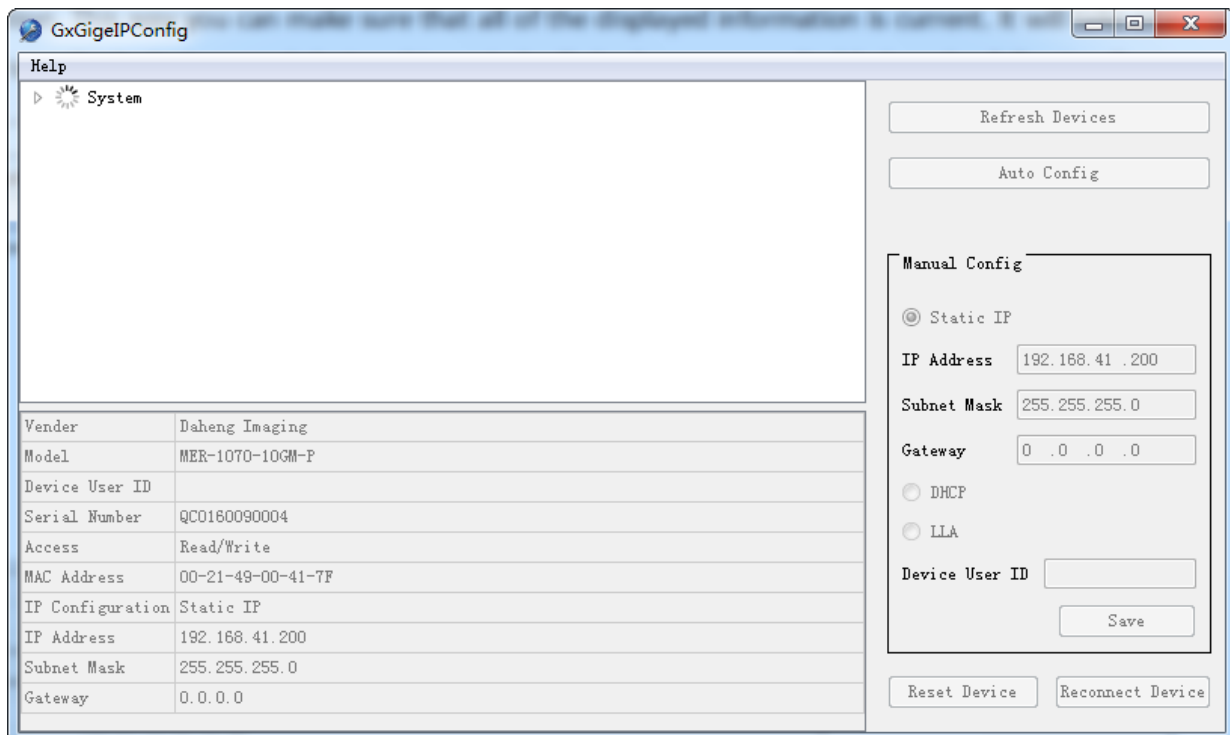

Figure 9-2 Refresh devices

9.1.2.2. Auto Config

You can configure the device's IP address manually or automatically. In manual mode, the user is required to understand the basic network knowledge and to set the device one by one manually. In auto mode, the program will be executed automatically without the operator intervening.

If a user needs a batch of network cameras with no IP conflict between them, the user needs to connect all the cameras to the network and to make sure that all the cameras can be enumerated by IP configurator, then performs the IP config function automatically. If the user sets these cameras in two times, the IP conflict between them will be possibly caused. Please refer to precautions 3.

The auto config function can configure the IP address of the network card and devices which enumerated by the network card in bulk, with one push and no input needed. According to the network card's IP and device's IP, the program can configure IP automatically, under the premise of avoiding IP conflicts to the greatest extent and making minimum changes. After this function is executed, the starting mode of the network device is changed to static IP start mode, and the IP address is changed to permanent IP.

The auto config function has three modes:

1) According to the network card's IP address

If the current network card's IP is valid (Valid IP: non LLA type IP and 0.0.0.0, the same below), but the IP of devices enumerated by this network card is in the following cases: IP not in the same subnet, IP is invalid and IP conflicts with other devices, the program will modify the device's IP to the same subnet. After selecting the **Auto Config**.

2) According to device's IP address

If the current network card's IP is invalid, but at least one of the IP address of the devices that enumerated by the current network card is valid (Let's say the device is A), please select **Auto Config**. According to the device's IP, the program will modify the current network card's IP to the same subnet with A, and also will modify all the devices with invalid IP under the current network card to the same subnet as device A.

3) According to the configuration file

If the current network card's IP and all the network devices' IP under the current network are invalid, the program will modify all the devices' IP under the network card and the network card's IP according to the configuration file (The configuration file is in the same directory as the tool). In the configuration file, the user only needs to specify the IP address segment and subnet mask that the network card is expected to be in. The user must input the private network address of A, B, and C. Otherwise, the program will set the network card's IP address and SubNetMask as 192.168.1/24 (IP:192.168.1.0, SubNetMask: 255.255.255.0).

- 1) This function will modify the network card's IP when the IP of the host network card is invalid. The network card's IP which is modified may be different from the IP of user work network.



- 2) The program will avoid IP conflict when modifying the IP of the device and the network card. But under the Windows system, the program is difficult to discover the IP conflict between network devices and other non-network devices on the network. In this case, the **Auto Config** operation may fail.

- 3) When the user configures the network cameras' IP in batches using the **Auto Config** function under the same environment (First, connect a batch of cameras to perform this function, then replace another batch after completion), in the two sets of cameras, the IP address may conflict.

9.1.2.3. Display Information

When you select a network adapter in the tree list, the following adapter information is displayed in the information display window below the left side of the main window.

[Display Name] The description of the network adapter.

[IP Address] The IP address of the network adapter.

[Subnet Mask] The subnet mask of the network adapter.

[Gateway] The gateway of the network adapter.

When you select a camera feature in the tree list, the following camera information is displayed in the information display window below the left side of the main window.

[Vendor] The name of the camera vendor.

[Model] The name of the camera model.

[Device User ID] A user-defined identifier for the camera (if a camera has been assigned).

[Serial Number] The serial number of the camera.

[Status] The connection status of the camera.

[MAC Address] The MAC address of the camera.

[IP Configuration] The method used for assigning the current IP address to the camera.

[IP Address] The current IP address of the camera.

[Subnet Mask] The subnet mask of the camera.

[Gateway] The gateway used by the camera.

9.1.2.4. Configure IP Address

You should select the camera feature which is to be modified in the camera list, select **Static IP**, and input the **IP Address**, **Subnet Mask**, and default **Gateway**, then select **Save** to complete the IP address setting, at the same time, setting the IP configuration mode as **Static IP**, as shown in Figure 9-3:

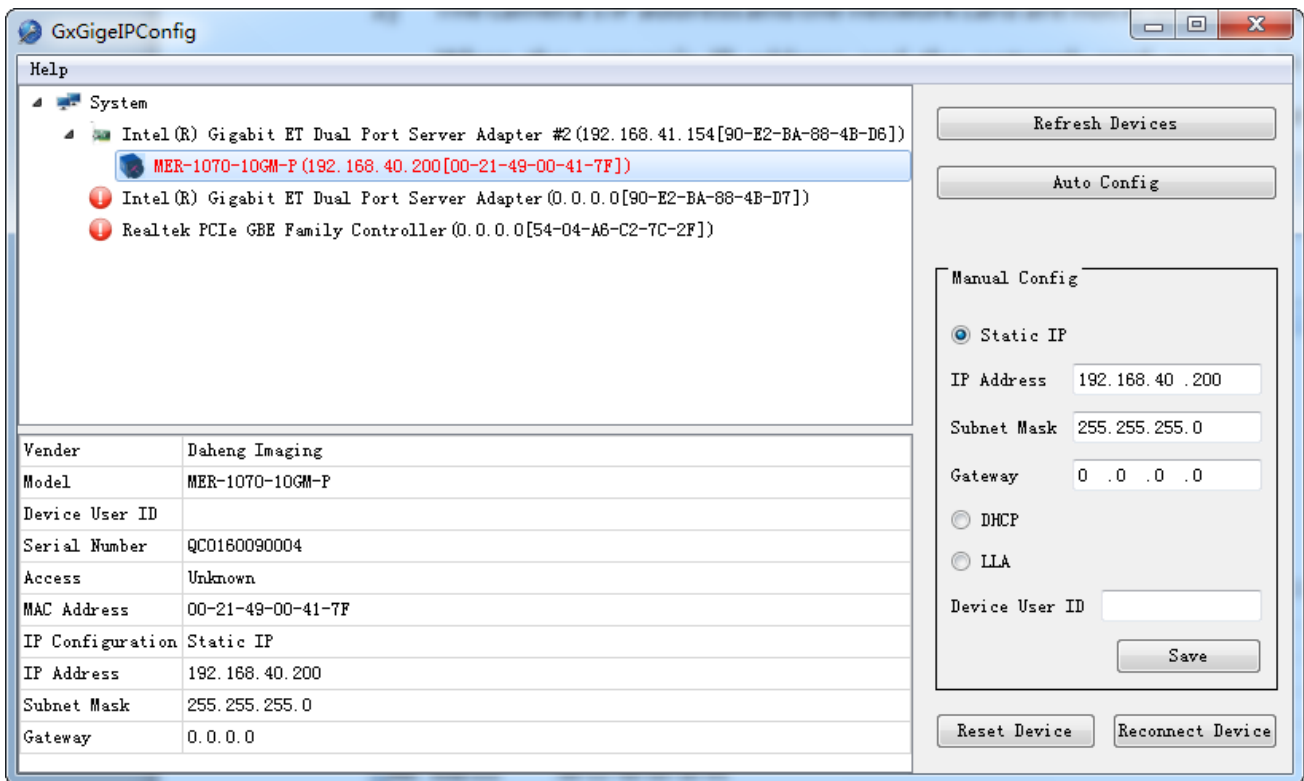

Figure 9-3 Configure IP address

9.1.2.5. IP Configuration Mode

You should select the camera feature which is to be modified in the camera list, select the **Static IP**, **DHCP**, or **LLA**, then select **Save**, the details are as follows:

1) To set a camera to a static IP address

See section 9.1.2.4 for details.

2) To set a camera to DHCP

Operation steps:

- a) In the top pane of the tool, select the camera whose IP configuration you want to change.
- b) In the right pane of the tool, select **DHCP**.
- c) Select the **Save** button. When the tool has finished saving, the information in the top pane and the lower left area will be updated automatically.

Operation results:

- a) Change the camera IP configuration mode as "DHCP".
- b) If operating successfully, the current IP address is the one which is allocated by the DHCP servers, if the DHCP servers is not exist, the camera's IP will be configured with LLA.

3) To set a camera to AUTO IP (LLA)

Operation steps:

- a) In the top pane of the tool, select the camera whose IP configuration you want to change.
- b) In the right pane of the tool, select **Auto IP (LLA)**.
- c) Select **Save**. When the tool has finished saving, the information in the top pane and the lower left area will have been updated automatically.

Operation results:

- a) Change the camera IP configuration mode as "LLA".
- b) If operating successfully, the current IP address is allocated with the LLA mode.

9.1.2.6. Change the Device User ID

- 1) In the top pane of the tool, select the camera whose device user ID you want to change.
- 2) Enter a new device user ID for the camera in the **Device User ID** field. You can only enter **ASCII** characters. The maximum length allowable is 16 bytes.
- 3) Select **Save**. When the tool has finished saving, the information in the top pane and the lower left area will have been updated automatically.

9.1.2.7. Reset Device and Reconnect Device

The button is not available if the device does not support this feature.

Reset Device: When the device is not convenient to power down, but also need to reload the program, this feature can be used at this time.

Reconnect Device: This function is generally used debugging device using Visual Studio. In debug mode, the heartbeat timeout is 5 minutes. If the user exits the process without closing device, the device cannot be reset immediately and device cannot be reopened immediately. In this case, you can use this feature to release the device control, you can immediately open the device.



Carefully use these two features. The use of those two features during acquisition can cause acquisition stop immediately.

9.1.3. Precautions

9.1.3.1. Check IP Address Format

It's not allowed to enter the following IP address in the IP Address field.

- 1) The IP of Class D: 224.0.0.0 to 239.255.255.254.
- 2) The IP of Class E: 240.0.0.0~255.255.255.254.
- 3) The first paragraph of the IP address is 127 and 255.

If you enter one of these IP addresses, a red exclamation mark will be displayed in the right of the IP Address field and the Save button will be disabled as shown in the Figure 9-4.

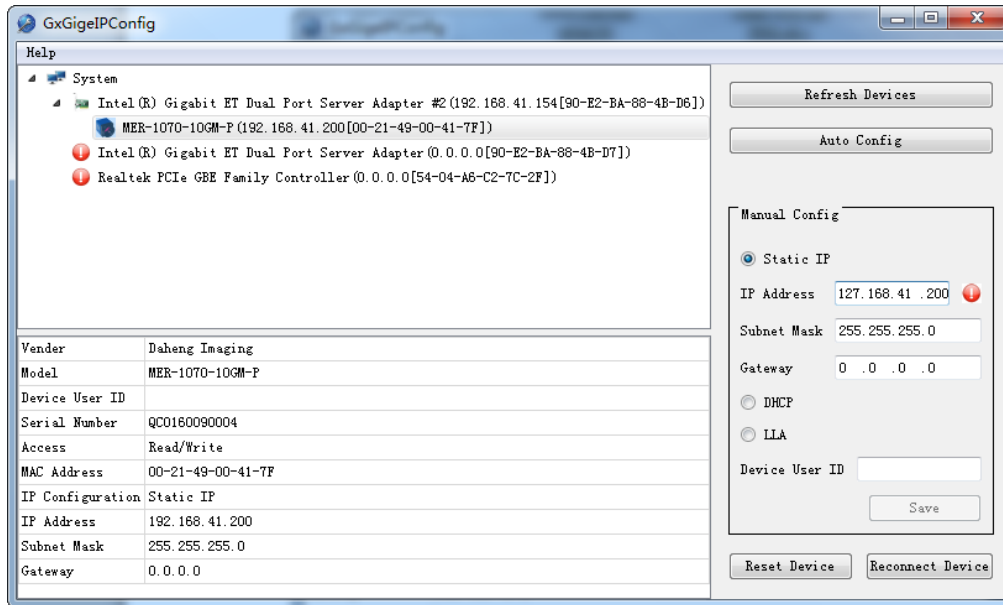

Figure 9-4 Check IP address format

9.1.3.2. Length Limitation of User-defined Name

The maximum allowable length of the user-defined name is 16 bytes.

9.1.3.3. Tips

- 1) The cameras' IP address are the same

If the cameras' IP address are the same, a red exclamation mark will be displayed in the right of the camera list, as shown in the Figure 9-5.

- 2) The camera's IP address and the network card are not in the same subnet

When the camera's IP address and the network card are not in the same subnet, the camera information in the enumeration list is marked in red, as shown in the Figure 9-5.

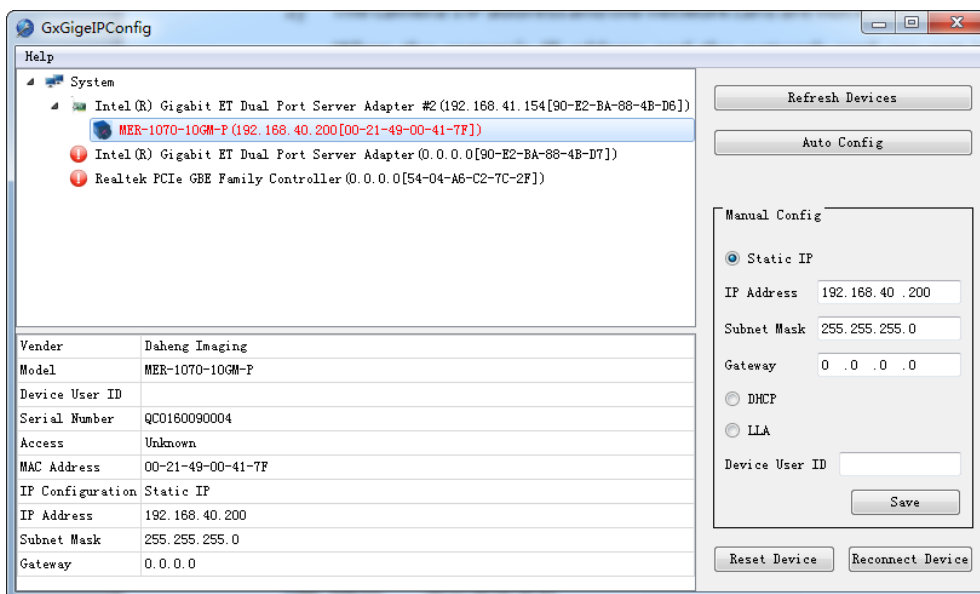

Figure 9-5 The tips of the IP configurator

9.2. Frame Rate Calculation Tool

Width	1292
Height	964
OffsetY	0
ExposureTime (us)	20000
PixelFormat (8/12)	8
GevSCPSPacketSize	1500
GevSCPD	0
GevLinkSpeed (Mbps)	1000
GevSCPDMaxValue	180000
BandwidthReserve	10
BandwidthReserveMaxValue	99
AcquisitionFrameRate	43.3
AcquisitionFrameRateMode	0
FPS	43.33

Figure 9-6 Frame rate calculation tool

The frame rate calculation tool is currently provided in the form of Excel. When using it, firstly select the camera model in the table, and then achieve the expected frame rate by modifying the parameter of the camera. There are four major types of influencing factors, including image readout time (image width, image height, pixel format), exposure time, acquisition frame rate setting value, and image transmission bandwidth influence (packet size, packet delay, reserved bandwidth, link speed, pixel format, image width, image height, pixel format).

The parameters in Figure 9-6 are explained as follows:

- 1) The Width and Height are the set ROI size.
- 2) The ExposureTime is the exposure time when the camera acquires one frame of image.
- 3) The PixelFormat is the pixel format corresponding to the camera output image, including 8 bits, 10 bits or 12 bits.
- 4) The GevSCPSPacketSize represents the packet size of the camera. The default value is 1500 bytes, and the maximum can be set to 16384 bytes. It is necessary to ensure that the network card and the switch support jumbo frames.
- 5) The GevSCPD represents the packet delay between each frame of images.
- 6) The LinkSpeed refers to the network link speed between the camera and the host, which is divided into 100Mbps/1000Mbps.
- 7) The GevSCPDMaxValue represents maximum packet delay can be set under the current parameters.

- 8) The BandwidthReserve represents the percentage of network bandwidth reserved for other network transmission, which is 10% by default.
- 9) The BandwidthReserveMaxValue represents the maximum reserved bandwidth that can be set under the current parameters.
- 10) The GevFramerateABS represents the maximum value of the GevFramerateAbsEn when GevFramerateAbsEn is enabled. Whether the maximum value can be reached depends on whether the camera is affected by other acquisition parameters.
- 11) The GevFramerateAbsEn indicates whether frame rate control is enabled, 1 means enable GevFramerateAbsEn, and 0 means disable GevFramerateAbsEn. When GevFramerateAbsEn is enabled, the camera acquires images at a frame rate that is no higher than the GevFramerateABS. When GevFramerateAbsEn is disabled, the camera acquires images without being affected by the GevFramerateABS.

When using the frame rate calculation tool, please fill in the above information of the camera into the corresponding table. When the filled value exceeds the range or does not conform to the rules, the calculation tool will report an error. Please modify and fill in the value again according to the prompt information. When all parameters are correctly filled in, the FPS shown in the last column of the table is the theoretical frame rate currently acquired by the camera, and usually the error between this value and the actual frame rate acquired by the camera is no more than 1%.

Take the MER-132-43GM/C camera as an example:

- 1) If you want to set the camera's acquisition frame rate to 40fps with the "GevFramerateABS" function, you can set "GevFramerateAbsEn" to 1, set "GevFramerateABS" to 40, and then you can check "FPS" as 40fps.
- 2) If you want to adjust "GevSCPSPacketSize" and "GevSCPD" to make the frame rate of the camera to 40fps, you can select the "GevSCPSPacketSize" you want to use. If you set "GevSCPSPacketSize" to 8192, then gradually set the value of "GevSCPD" to make "FPS" approach 40fps. After several attempts, it can be concluded that when "GevSCPD" is set to 10600, the calculated result "FPS" is 40.16 fps.

10. FAQ

No.	General Question	Answer
1	The LED of the power is not on when the MER-G-P series camera is powered via PoE network card.	1) Confirm whether the power of the PoE network card is connected.
2	No images after starting acquisition.	<ol style="list-style-type: none"> 1) Confirm that the camera packet size is greater than 1500, generally the packet size is set to be the maximum. If the host is not in jumbo frame mode, modify the maximum size of the IP packet to jumbo frame mode. 2) Load the default parameter set, reopen the application program, and then start acquisition again. 3) Run the demo program, and open the configuration page to confirm whether the data packet is received. If there are data packets, but they are all incomplete frames, please check your environment requirements in section 2.2.
3	The frame rate is not up to the nominal value.	<ol style="list-style-type: none"> 1) Choose a better host. 2) Choose a recommended Intel series Gigabit network card. 3) Contact with the technical support.
4	Lose frames seriously in a multiple cameras' application.	<ol style="list-style-type: none"> 1) Adjust the packet size or packet delay, but frame rate reducing followed. 2) Using multiple network cards, and the cameras are connected separately to different network cards.
5	On the unactivated Windows7 64bit system, the installation of GalaxySDK has been successfully, but open the demo program failed.	1) Activate Windows7 64bit system, uninstall the package. Then, reinstall the package after restarting the system, and reopen the demo program.
6	Fail to open device, prompting the XML file parsing error.	1) Contact with the technical support to obtain upgrade program, and then upgrade your cameras.
7	Cannot receive any image after modifying the packet delay to a larger value.	1) Confirm the data block timeout settings in the configuration page, and adjust the timeout settings until the image data is received.
8	The cameras cannot be enumerated On Windows XP.	<ol style="list-style-type: none"> 1) Check if the network is connected. 2) Enumerate repeatedly. 3) Modify the host IP address, and enumerate once again.

<p>9</p>	<p>The device fails to start acquisition, and the "Attach Buffer fails" error occurs.</p>	<ol style="list-style-type: none"> 1) Method 1: Modify the stream layer parameter MaxNumQueueBuffer (the maximum buffer number of acquisition queue) to below 9, this solution may reduce the acquisition performance, for the user who has low requirement of acquisition frame rate or the user who use trigger mode can select this way, but it is not recommended to the user who has higher requirements of acquisition frame rate. 2) Method 2: Increasing the physical memory size and replacing the 32bit system with a 64bit system. It is recommended to use Windows7 or above, this is a good solution to this problem.
<p>10</p>	<p>MER-131-75GM/C-P MER-131-75GM/C-P NIR MER-131-75GM/C MER-1070-10GM/C-P MER-1070-10GM/C MER-1520-7GC-P MER-1520-7GC Use PCI network card, the above cameras' acquisition frame rate is 0.</p>	<ol style="list-style-type: none"> 1) Adjusting the acquisition parameters, to reduce the acquisition frame rate of the camera. 2) Change the network card to a PCI-E interface card.

11. Revision History

No.	Version	Changes	Date
1	V1.0.0	First release	2017-09-06
2	V1.0.1	Updated descriptions of MER-051-120GM/C-P & MER-051-120GM/C	2017-09-18
3	V1.0.2	Updated descriptions of MER-133-54GM/C-P & MER-133-54GM/C	2017-10-26
4	V1.0.3	Updated ExposureTime Range of MER-030-120GM/C & MER-030-120GM/C-P	2017-11-21
5	V1.0.4	Updated Gain Range of MER-051-120GM/C & MER-051-120GM/C-P	2017-12-04
6	V1.0.5	Updated PixelFormat of MER-531-20GM/C-P	2017-12-11
7	V1.0.6	Updated 1.5&1.6 Mechanical dimensions	2017-12-27
8	V1.0.7	Updated Signal Noise Ratio and Definition	2017-12-28
9	V1.0.8	Add MER-232-48GM-P NIR	2018-01-11
10	V1.0.9	Update Logo	2018-01-28
11	V1.0.10	Add MER-2000-5GM/C-P	2018-02-02
12	V1.0.11	Updated ExposureTime Range of MER-051-120GM/C & MER-051-120GM/C-P&MER-232-48GM-P NIR Updated 4.1 GigE IP Configuration	2018-03-06
13	V1.0.12	Correct the Pixel Formats of MER-2000-5GM-P	2018-03-07
14	V1.0.13	Add MER-630-16GM/C-P / MER-630-16GM/C / MER-2000-5GM/C	2018-03-27
15	V1.0.14	Add MER-201-25GM/C/MER-201-25GM/C-P	2018-04-11
16	V1.0.15	Add MER-1220-9GM/C/MER-1220-9GM/C-P	2018-04-19
17	V1.0.16	Add FCC Certifications	2018-05-23
18	V1.0.17	Add auto IP Configuration chapter	2018-05-29
19	V1.0.18	Updated Signal Noise Ratio and Definition	2018-06-22

No.	Version	Changes	Date
20	V1.0.19	Updated Signal Noise Ratio and Definition of MER-504-10GM/C-P	2018-09-04
21	V1.0.20	Modify the MER-131-75GM/C& MER-131-75GM/C-P & MER-131-75GM-P NIR Exposure Min Value	2018-11-16
22	V1.0.21	Modify the MER-132-30GM/C Exposure Min Value	2018-11-22
22	V1.0.22	Add MER-041-302GM/C/MER-041-302GM/C-P Updated Signal Noise Ratio	2018-12-23
23	V1.0.23	Updated frame rate descriptions of MER-041-302GM/C-P & MER-041-302GM/C Updated Signal Noise Ratio and Definition of MER-041-302GM/C-P & MER-041-302GM/C	2018-12-27
24	V1.0.24	Modify the structure of the manual Delete the description of definition	2020-01-21
25	V1.0.25	Update Figure1-1 Modify the conformity of MER-051-120GC/M-P	2020-06-05
26	V1.0.26	Modify the description of Figure 6-1 and Figure 6-2	2020-06-16
27	V1.0.27	Add MER-203-30GC-P-L, MER-203-30GC-P-L-F03 Add HN-20M, HN-P-6M, HN-P-10M, HN-P-25M series of industrial lenses Modify some description in section 6.2	2021-07-21
28	V1.0.28	Add MER-204-30GC-P-L-F02 Add HN-6M series of industrial lenses	2021-10-19
28	V1.0.29	Add MER-503-20GM/C	2021-11-16

12. Contact Us

12.1. Contact Sales

If you need to order products or inquire product information, please contact our sales:

Tel: +86 10 8282 8878

Email: isupport@daheng-imaging.com

12.2. Contact Support

If you have any questions in using DAHENG IMAGING products, please contact the experts on our support team:

Tel: +86 10 8282 8878

Email: isupport@daheng-imaging.com