

China Daheng Group, Inc. Beijing Image Vision Technology Branch

# MARS USB3 Vision Cameras

## User Manual

Version: V2.0.1  
Date: 2023-09-09

**DAHENG** | **大恒图像**  
**IMAGING**

All rights reserved. No parts of this manual may be used or reproduced, in any forms or by any means, without prior written permission of China Daheng Group, Inc. Beijing Image Vision Technology Branch.

The right is also reserved to modify or change any parts of this manual in the future without prior notification.

All other trademarks are the properties of their respective owners.

© 2023 China Daheng Group, Inc. Beijing Image Vision Technology Branch

Web: [www.daheng-imaging.com/en](http://www.daheng-imaging.com/en)

Sales Email: [isales@daheng-imaging.com](mailto:isales@daheng-imaging.com)

Sales Tel: +86 10 8282 8878-8081

Support Email: [isupport@daheng-imaging.com](mailto:isupport@daheng-imaging.com)

# Preface

We really appreciate your choosing of DAHENG IMAGING products.

The MARS USB3.0 series camera is DAHENG IMAGING's latest area scan industrial digital camera with large and high-quality sensor, featuring high resolution, high definition and extremely low noise. The camera is equipped with standard USB3.0 interface, is easy to install and use.

The MARS family cameras are especially suitable for machine vision applications such as industrial inspection, medical, scientific research, education, security and so on.

This manual describes in detail on how to install and use the MARS USB3 Vision digital cameras.

# Contents

<b>1. Introduction</b> .....	<b>1</b>
1.1. Series Introduction .....	1
1.2. Naming Rules .....	1
1.3. Standards .....	1
1.4. Document, CAD/Technical Drawing and Software Downloads .....	1
<b>2. Precautions</b> .....	<b>2</b>
2.1. Safety Claim .....	2
2.2. Safety Instruction .....	2
2.3. Guideline for Avoiding EMI and ESD .....	3
2.4. Environmental Requirements .....	3
2.5. Camera Mechanical Installation Precautions .....	4
2.6. Certification and Declaration .....	4
<b>3. Installation</b> .....	<b>5</b>
3.1. Host Preparation .....	5
3.1.1. Software Package .....	5
3.1.2. User Software Interface .....	5
3.2. Camera Power .....	6
3.3. Camera Driver Installation .....	7
3.3.1. System Requirements .....	7
3.3.2. Driver Installation .....	7
3.4. Open Device and Start Acquisition .....	7
<b>4. General Specification</b> .....	<b>8</b>
4.1. Explanation of Important Parameters .....	8
4.1.1. About Spectral Response .....	8
4.2. MARS-3250-12U3M/C .....	8
4.3. MARS-4470-8U3M/C .....	10
<b>5. Dimensions</b> .....	<b>12</b>
5.1. Camera Dimensions .....	12
5.2. Optical Interface .....	13
5.3. Tripod Adapter Dimensions .....	13
<b>6. Filters and Lenses</b> .....	<b>15</b>
6.1. Filters .....	15
6.2. Lens Selection Reference .....	16

6.2.1. HN-2M Series .....	17
6.2.2. HN-5M Series .....	17
6.2.3. HN-6M Series .....	18
6.2.4. HN-20M Series .....	19
6.2.5. HN-P-6M Series .....	19
6.2.6. HN-P-10M Series .....	20
6.2.7. HN-P-20M Series Prime Lenses .....	20
6.2.8. HN-P-25M Series .....	21
6.2.9. HN-P Series 8K ~ 16K Line Scan Lenses.....	21
<b>7. Electrical Interface.....</b>	<b>23</b>
7.1. LED Light.....	23
7.2. USB Port .....	23
7.3. I/O Port.....	23
7.3.1. I/O Port Definition .....	23
7.3.2. I/O Electrical Characteristics .....	24
7.3.2.1. Line0 (Opto-isolated Input) Circuit.....	24
7.3.2.2. Line1 (Opto-isolated Output) Circuit.....	26
7.3.2.3. GPIO 2/3 (Bidirectional) Circuit .....	28
<b>8. Features .....</b>	<b>32</b>
8.1. I/O Control .....	32
8.1.1. Input Mode Operation.....	32
8.1.2. Output Mode Operation.....	33
8.1.3. Read the LineStatus .....	38
8.2. Image Acquisition Control.....	38
8.2.1. Acquisition Start and Stop .....	38
8.2.1.1. Acquisition Start .....	38
8.2.1.2. Acquisition Stop .....	39
8.2.2. Acquisition Mode .....	40
8.2.3. Trigger Type Selection .....	41
8.2.4. Switching Trigger Mode.....	42
8.2.5. Continuous Mode and Configuration.....	44
8.2.6. Acquisition Burst Mode.....	44
8.2.7. Software Trigger Acquisition and Configuration.....	45
8.2.8. Hardware Trigger Acquisition and Configuration .....	45
8.2.9. Overlapping Exposure and Non-overlapping Exposure.....	46
8.2.10. Set Exposure .....	48
8.2.10.1. Set Exposure Mode .....	48
8.2.10.2. Set Sensor Exposure Mode.....	50
8.2.10.3. Set Exposure Time .....	52
8.2.10.4. Set Value of Exposure Time .....	53

8.2.11. Exposure Delay .....	53
<b>8.3. Basic Features .....</b>	<b>55</b>
8.3.1. Gain .....	55
8.3.2. Pixel Format.....	55
8.3.3. ROI.....	60
8.3.4. Auto Exposure/Auto Gain.....	60
8.3.4.1. ROI Setting of Auto Exposure/ Auto Gain .....	60
8.3.4.2. Auto Gain .....	61
8.3.4.3. Auto Exposure .....	62
8.3.5. Test Pattern .....	62
8.3.6. User Set Control .....	64
8.3.7. Device User ID .....	66
8.3.8. Timestamp .....	67
8.3.9. Binning.....	67
8.3.10. Decimation.....	69
8.3.11. Reverse X and Reverse Y .....	71
8.3.12. Digital Shift.....	73
8.3.13. Acquisition Status .....	74
8.3.14. Black Level .....	75
8.3.15. Remove Parameter Limits.....	75
8.3.16. User Data Area .....	76
8.3.17. Timer.....	76
8.3.18. Counter .....	77
<b>8.4. Image Processing.....</b>	<b>77</b>
8.4.1. Light Source Preset .....	77
8.4.2. Auto White Balance .....	78
8.4.2.1. Auto White Balance ROI.....	78
8.4.2.2. Auto White Balance Adjustment .....	79
8.4.3. Color Transformation Control .....	80
8.4.4. Gamma .....	81
8.4.5. Sharpness.....	82
8.4.6. Lookup Table .....	83
8.4.7. Flat Field Correction .....	84
8.4.7.1. FFC Coefficient Calculation and Preview .....	85
8.4.7.2. Read/Save Coefficient .....	86
8.4.7.3. Load/Save File .....	86
8.4.7.4. Precautions .....	86
8.4.8. Noise Reduction .....	87
8.4.9. Saturation .....	87
<b>8.5. Image Transmission .....</b>	<b>88</b>
8.5.1. Calculate Frame Rate.....	88

8.5.2. USB Interface Bandwidth .....	89
8.5.3. DeviceLinkThroughputLimit.....	89
8.5.4. Camera Acquisition Time .....	90
8.6. Events .....	90
8.6.1. ExposureEnd Event.....	92
8.6.2. BlockDiscard Event .....	92
8.6.3. BlockNotEmpty Event.....	92
8.6.4. FrameStartOvertrigger Event .....	92
8.6.5. FrameBurstStartOvertrigger Event.....	92
8.6.6. FrameStartWait Event .....	92
8.6.7. FrameBurstStartWait Event.....	93
<b>9. Software Tool.....</b>	<b>94</b>
9.1. LUT Create Tool.....	94
9.1.1. GUI.....	94
9.1.2. User Guide.....	95
9.1.2.1. User Case .....	95
9.1.2.2. GroupBox.....	95
9.1.2.3. Auto Create Lut.....	97
9.1.2.4. Save Lut.....	98
9.1.3. Precautions.....	98
9.1.3.1. Read From Device .....	98
9.1.3.2. Write To Device .....	98
9.1.3.3. Directory Structure .....	98
9.2. Flat Field Correction Plugin .....	98
9.2.1. GUI.....	99
9.2.2. User Guide.....	100
9.2.2.1. FFC Execution Steps.....	100
9.2.2.2. Acquisition of Bright Field Images .....	100
9.2.2.3. Execute FFC .....	101
9.2.2.4. Read FFC Data from Device / Write FFC Data to Device.....	101
9.2.2.5. Load FFC Data from File / Save FFC Data to File .....	101
9.2.3. Precautions.....	101
9.2.3.1. FFC is not Supported.....	101
9.2.3.2. Preview .....	102
9.3. Static Defect Correction Plugin.....	102
9.3.1. Static Defect Correction Steps .....	105
9.3.2. Acquisition Images .....	105
9.3.3. Static Defect Correction.....	106
9.3.4. How to Use Defect Pixel Data File .....	106
9.4. Frame Rate Calculation Tool.....	107
<b>10. FAQ.....</b>	<b>109</b>

<b>11. Revision History .....</b>	<b>111</b>
<b>12. Contact Us .....</b>	<b>112</b>
12.1. Contact Sales .....	112
12.2. Contact Support .....	112



## 1. Introduction

### 1.1. Series Introduction

The MARS USB3 Vision series camera is DAHENG IMAGING's mature area scan industrial digital camera, featuring outstanding performance, powerful features, and outstanding price/performance ratio. The MARS-U3 series cameras are available in a variety of resolutions and frame rates, and are available with CMOS sensors from leading chip manufacturers, which is easy to install and use.

The MARS-U3 series digital camera transmits image data through the USB3.0 data interface. Thanks to the locking screw connectors, the MARS series cameras can secure the reliability of cameras deployed in harsh industrial environments. Featuring high reliability and high price/performance ratio, the MARS series cameras are especially suitable for machine vision applications such as industrial inspection, medical, scientific research, education, security and so on.

### 1.2. Naming Rules

Details of the MARS USB3 Vision series (MARS-U3) camera are given in the general specifications below. Each camera model name is determined by its sensor's maximum resolution, maximum frame rate at maximum resolution, the color/monochrome type of the sensor, etc.



Figure 1-1 Naming rules

### 1.3. Standards

The camera follows the USB3 Vision1.0 standard, and its development interface GalaxySDK is implemented based on the GEN<i>CAM standard.

### 1.4. Document, CAD/Technical Drawing and Software Downloads



Product related document, CAD/Technical drawing, tools and software can be downloaded from the [Downloads](#) of DAHENG IMAGING website.

## 2. Precautions



### 2.1. Safety Claim

Before installing and using DAHENG IMAGING products, please carefully read this manual and strictly comply with the usage requirements. And ensure to use the product in specified conditions, otherwise it may cause equipment malfunction. Our company will not bear any legal responsibility for any damage or injury caused by improper use of this product and disregard of safety instructions.

The symbols that may be found in this document are defined as follows:

Symbol	Description
	Note: Provides additional information to emphasize or supplement important points of the main text
	Caution: Indicates a potentially hazardous situation which, if not avoided, could result in equipment damage, data loss, performance degradation, or unexpected results
	Warning: Indicates a potential risk that, if not avoided, could result in injury accidents, equipment damage, or business interruption
	Danger: Indicates a hazard with a high level of risk, which if not avoided, will result in death or serious injury

### 2.2. Safety Instruction

Usage	
 Warning	<ol style="list-style-type: none"> <li>1) Do not install and operate the product in extreme environments with vibration, high temperature, humidity, dust, strong magnetic fields, explosive/corrosive smoke or gases, as it may damage the camera, cause a fire or electric shock.</li> <li>2) Do not aim at the product with high intensity light sources directly, as it may damage the sensor.</li> <li>3) If the device damaged, emits smoke, odor or noise, please turn off the power and unplug the power cord immediately, and contact our technical support engineer.</li> <li>4) Unauthorized disassembly, repair, or modification of products is prohibited as it may damage the camera or cause a risk of electric shock.</li> <li>5) In the use of the device, you must be in strict compliance with the electrical safety regulations of the nation and region.</li> <li>6) Please use the power supply provided by reputable manufacturers that meets the camera power limit requirements, otherwise, it will damage the camera.</li> </ol>
 Caution	<ol style="list-style-type: none"> <li>1) Check whether the device's package is in good condition, whether there is damage, deformation, etc. before unpacking.</li> <li>2) After unpacking, please carefully inspect the quantity and appearance of the product and accessories for any abnormalities.</li> <li>3) Please store and transport the product according to the specified storage and transportation conditions, ensure that the storage temperature and humidity meet the requirements.</li> </ol>

Personal Safety	
 Warning	<ol style="list-style-type: none"><li>1) It is strictly prohibited to perform device wiring, dismantling, maintenance and other operations while powered on, otherwise there may be a risk of electric shock.</li><li>2) It is prohibited to touch the camera directly during using, otherwise there may be a risk of burns.</li><li>3) Please install and use the camera in accordance with regulations, otherwise there may be a risk of falling and get injured.</li><li>4) The edges of the lens mount and fan are relatively sharp, so pay attention to the risk of scratches during installation or use.</li></ol>

### 2.3. Guideline for Avoiding EMI and ESD

You should consider the EMI (Electro Magnetic Interference) and ESD (Electro-Static discharge) problem in the process of using the camera, to guarantee the camera to work in a relatively good electromagnetic environment. The main measures are as follows:

- 1) USB cables certificated by USB IF with lock screw are recommended.
- 2) Using shielded cable can avoid electro-magnetic interface. Shielding layer of the cable should conduct to ground nearby and not until stretched too long. When many devices need conduct to ground, using single point grounding to avoid earth loop.
- 3) Keep your cameras away from equipment with high voltage, or high current (such as motor, inverter, relay, etc.). If necessary, use additional shielding.
- 4) ESD (electro-static discharge) may damage cameras permanently, so use suitable clothing (cotton) and shoes, and touch the metal to discharge the electro-static before operating cameras.

### 2.4. Environmental Requirements

- 1) Housing temperature during operation: 0°C ~ 45°C, humidity during operation: 10% ~ 80%.

Storage temperature: -20°C ~ 70°C.

- 2) To avoid collecting dust in the optical filter, always keep the plastic cap on cameras when no lens is mounted.
- 3) PC requirement: Intel Core 2 Duo, 2.4GHz or above, and 2GB memory or above.
- 4) USB3.0 host controller requirement: Intel controller integrated in mainboard is recommend. Select Renesas controller if external frame grabber is needed.
- 5) The cable must have a locking screw at the end of the device.
- 6) Make sure that cameras are transported in the original factory packages.

## 2.5. Camera Mechanical Installation Precautions

Camera installation requirements:

- 1) The screw and camera have a screw length between 3 and 4.8 mm.
- 2) Screw assembly torque  $\leq 5\text{N}\cdot\text{M}$ . If the screw assembly torque is too large, it may cause the camera thread stripping.

## 2.6. Certification and Declaration

### 1. CE, RoHS

We declare that DAHENG IMAGING MARS USB3 digital cameras have passed the following EU certifications:

- 2014/30/EU—Electromagnetic Compatibility Restriction
- 2011/65/EU—Restriction of Hazardous Substances (RoHS) and its revised directive 2015/863/EU



Equipment meeting Class A requirements may not offer adequate protection to broadcast services within a residential environment.

### 2. FCC

This device complies with Part 15 of the FCC Rules. Operation is subject to the following two conditions:

- This device may not cause harmful interference
- This device must accept any interference received, including interference that may cause undesired operation

**Note:** This equipment has been tested and found to comply with the limits for a Class A digital device, pursuant to Part 15 of the FCC Rules. These limits are designed to provide reasonable protection against harmful interference when the equipment is operated in a commercial environment. This equipment can generate, uses, and radiate radio frequency energy and, if not installed and used in accordance with the instruction manual, may cause harmful interference to radio communications. Operation of this equipment in a residential area is likely to cause harmful interference in which case the user will be required to correct the interference at his own expense.

## 3. Installation

### 3.1. Host Preparation

#### 3.1.1. Software Package

The software package of DAHENG IMAGING's MARS series is used to control the MARS series camera to provide stable, real-time image transmission, and provides multiple samples and easy-to-integrate SDKs for various programming tools. The package is composed of the following modules:

- 1) Driver Package (Driver): This package provides the MARS series camera driver program, such as: the USB3.0 cameras' driver program.
- 2) Interface Library (API): This package provides the camera control interface library and the image processing interface library, supports the user for secondary development.
- 3) Demonstration Program (GalaxyView.exe): This demonstration program is used to display the camera control, image acquisition and image processing functions, the user can control the camera directly by the demonstration program, and the user can develop their own control program based on the camera interface library.
- 4) Sample: These samples demonstrate cameras' functions, the user can easily use these samples to control cameras, or refer to the samples to develop their own control programs.
- 5) Programmer's Manual: This manual is the users programming guide that instructs the users how to configure the programming environment and how to control cameras and acquire images through the camera interface library.

You can download the latest software package from the website: [www.daheng-imaging.com/en/Downloads](http://www.daheng-imaging.com/en/Downloads).

#### 3.1.2. User Software Interface

After installing the MARS series camera software package, the user can use the demonstration program and the samples to control the camera, also the user can control the camera by the program which is written by the user themselves. The software package provides three kinds of program interface, the user can select the suitable one for use according to their own requirements:

##### 1) API Interface

In order to simplify the users' programming complexity, the package provides the general C programming interface GxIAPI.dll and image processing algorithm interface DxImageProc.dll for the user to control the camera, and provides the samples and software development manual which are based on these interfaces. The API interface supports C/C++/C#/Python, etc.

##### 2) GenTL Interface

This interface is developed according to the standard of general transport layer in GEN<i>CAM standard, DAHENG IMAGING follows the GEN<i>CAM standard and provides the GenTL interface for the user, the

user can use the GenTL interface directly to develop their own control program. The definition and usage of GenTL interfaces can be downloaded from the website of EMVA.

In addition, users can use some third-party software that supports GEN<i>CAM standard to control the camera, such as HALCON.

### 3) USB3 Vision interface

The MARS series USB3.0 camera is compatible with the USB3 Vision protocol, which allows the user to control the camera directly through the USB3 Vision protocol. In addition, the user can use some third-party software that supports the USB3 Vision protocol to control the camera, such as HALCON.

● **Note**

GEN<i>CAM standard: GEN<i>CAM is administered by the European Machine Vision Association (EMVA). GenICam provides a generic programming interface for all kinds of cameras and devices. It provides a standard application programming interface (API), no matter what interface technology is being used. It mainly includes the following modules:

- GenAPI: an XML description file format defining how to capture the features of a device and how to access and control these features in a standard way
- GenTL: a generic Transport Layer Interface, between software drivers and libraries, that transports the image data from the camera to the application running on a PC
- SFNC: common naming convention for camera features, which promotes interoperability between products from different manufacturers

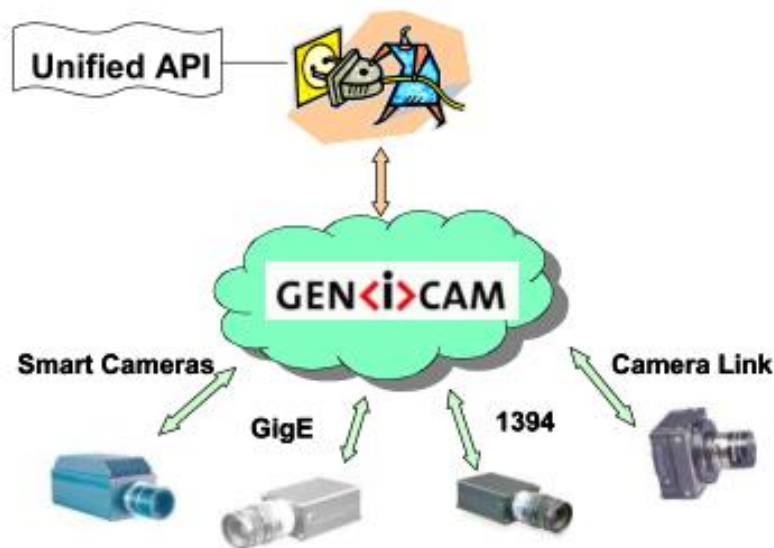

Figure 3-1 GEN<i>CAM standard schematic diagram

## 3.2. Camera Power

MARS-U3 series camera adopts external power supply and need large power consumption. The power supply must be +12V (- 10%) ~ +24V (+ 10%).

### 3.3. Camera Driver Installation

#### 3.3.1. System Requirements

GalaxySDK is suitable for all cameras in the MARS series. The GalaxySDK contains various operating systems such as Windows, Android and Linux. The requirements for the operating system and version of the installation package are as follows:

Operating Systems	Applicable Version
Windows	<ul style="list-style-type: none"><li>➤ Windows 7 (32bit, 64bit)</li><li>➤ Windows 10 (32bit, 64bit)</li><li>➤ Windows 11 (64bit)</li></ul>
Linux	<ul style="list-style-type: none"><li>➤ Ubuntu 12.04 or above, kernel version 3.5.0.23 or above</li></ul>
Android	<ul style="list-style-type: none"><li>➤ Android6 or above</li></ul>

#### 3.3.2. Driver Installation



The steps to install the Galaxy SDK under Windows are as follows:

- 1) Download the corresponding version of the installation package from [www.daheng-imaging.com/en/Downloads](http://www.daheng-imaging.com/en/Downloads).
- 2) Run the installer.
- 3) Follow the instructions of the installation wizard to complete the installation process. During the installation process, you can choose the camera interface you need (USB2.0, USB3 Vision, GigE Vision, etc.).

During the installation process, especially when installing the \*.sys file, you must always pay attention to whether the anti-virus software intercepts the driver. If intercepted, it may cause the driver installation to fail.

### 3.4. Open Device and Start Acquisition

After powering the device, connecting the device to the USB3.0 interface of the host. Double-click the GalaxyView software to acquire image. The steps are as follows:

- 1) Click the  icon on the Device Tree in the GalaxyView to refresh device list.
- 2) After the device is enumerated, double-click the device enumerated in the device list.
- 3) Click the  icon on the Device Tree to perform the Start Acquisition operation on the current device.

## 4. General Specification

### 4.1. Explanation of Important Parameters

#### 4.1.1. About Spectral Response

QE: Quantum efficiency, which is the ratio of the average number of photoelectrons produced per unit time to the number of incident photons at a wavelength.

Sensitivity: The change of the sensor output signal relative to the incident light energy. The commonly used sensitivity units are  $V/((W/m^2)\cdot s)$ ,  $V/lux\cdot s$ ,  $e^-/((W/m^2)\cdot s)$  or  $DN/ ((W/m^2)\cdot s)$ .

The spectral response graphs given by different manufacturers are different. Some graphs' ordinate is relative sensitivity response, and abscissa is wavelength. Some graphs' ordinate is QE, and abscissa is wavelength.

### 4.2. MARS-3250-12U3M/C

Specifications	MARS-3250-12U3C	MARS-3250-12U3M
Resolution	6576 × 4940	
Sensor	ON XGS32000 Global Shutter CMOS	
Max. Image Circle	APS-C	
Pixel Size	3.2 $\mu$ m × 3.2 $\mu$ m	
Frame Rate	12.1fps @ 6576 × 4940	
ADC Bit Depth	12bit	
Pixel Bit Depth	8bit, 12bit	
Mono/Color	Color	Mono
Pixel Formats	Bayer RG8/Bayer RG12	Mono8/Mono12
Signal Noise Ratio	39.56dB	39.61dB
Exposure Time	UltraShort: 92 $\mu$ s~161 $\mu$ s, Actual Steps: 1 $\mu$ s Standard: 162 $\mu$ s~1s, Actual Steps: 1 row period	
Gain	0dB~24dB. Default: 0dB, Step: 0.1dB	
Binning	1×1, 1×2, 1×4, 2×1, 2×2, 2×4, 4×1, 4×2, 4×4	
Decimation	Sensor: 1×1, 1×2, 2×1, 2×2	



Synchronization	Hardware trigger, software trigger
I/O	1 input and 1 output with opto-isolated, 2 bidirectional programmable GPIOs
Operating Temp	0°C~45°C
Storage Temp	-20°C~70°C
Operating Humidity	10%~80%
Power Requirements	12VDC-10% ~ 24VDC+10%
Power Consumption	5.6W @ 24V
Lens Mount	M42, F
Data Interface	USB3.0
Dimensions	62mm × 62mm × 53.77mm (without mount length)
Weight	308g
Operating System	Windows 7/10/11 32bit/64bit, Linux, Android, ARMv7, ARMv8
Programmable Control	Image size, gain, exposure time, trigger polarity, flash polarity
Conformity	CE, RoHS, FCC, USB3 Vision, GenICam

Table 4-1 MARS-3250-12U3M/C camera specifications

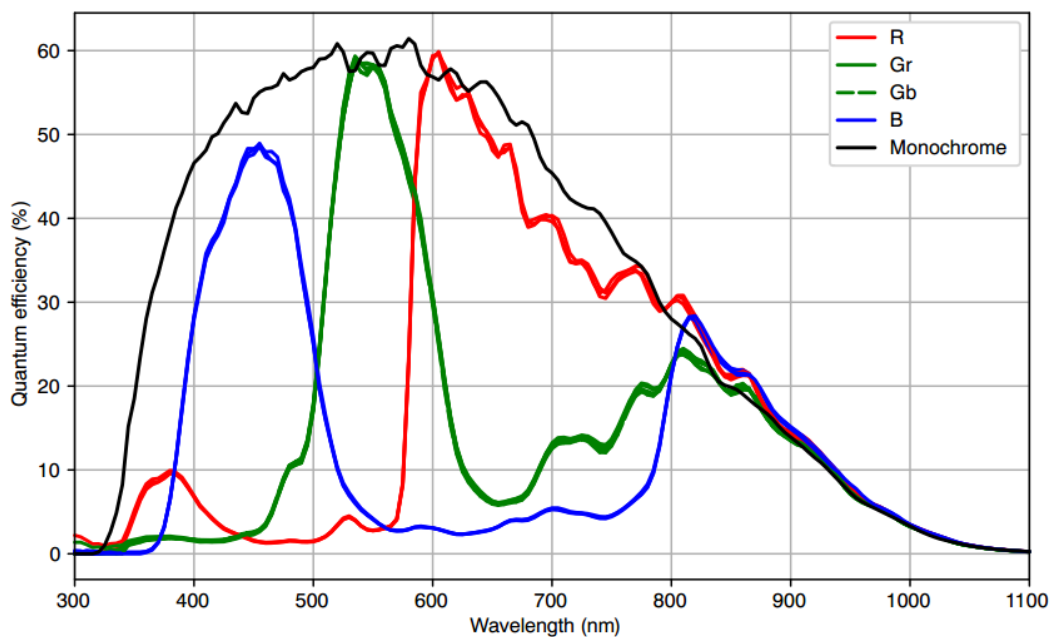

Figure 4-1 MARS-3250-12U3M/C sensor spectral response

## 4.3. MARS-4470-8U3M/C

Specifications	MARS-4470-8U3C	MARS-4470-8U3M
Resolution	8192 × 5460	
Sensor	ON XGS45000 Global Shutter CMOS	
Max. Image Circle	Super 35mm	
Pixel Size	3.2μm × 3.2μm	
Frame Rate	8.8fps @ 8192 × 5460	
ADC Bit Depth	12bit	
Pixel Bit Depth	8bit, 12bit	
Mono/Color	Color	Mono
Pixel Formats	Bayer RG8/Bayer RG12	Mono8/Mono12
Signal Noise Ratio	39.69dB	39.57dB
Exposure Time	UltraShort: 92μs~161μs, Standard: 162μs~1s	
Gain	0dB~24dB. Default: 0dB, Step: 0.1dB	
Binning	1×1, 1×2, 1×4, 2×1, 2×2, 2×4, 4×1, 4×2, 4×4	
Decimation	Sensor: 1×1, 1×2, 2×1, 2×2	
Synchronization	Hardware trigger, software trigger	
I/O	1 input and 1 output with opto-isolated, 2 bidirectional programmable GPIOs	
Operating Temp	0°C~45°C	
Storage Temp	-20°C~70°C	
Operating Humidity	10%~80%	
Camera Power Requirements	12VDC-10% ~ 24VDC+10%	
Power Consumption	5.6W @ 24V	
Lens Mount	M42, F	
Data Interface	USB3.0	

Dimensions	62mm × 62mm × 53.77mm (without mount length)
Weight	308g
Operating System	Windows 7/10/11 32bit/64bit, Linux, Android, ARMv7, ARMv8
Programmable Control	Image size, gain, exposure time, trigger polarity, flash polarity
Conformity	CE, RoHS, FCC, USB3 Vision, GenICam

Table 4-2 MARS-4470-8U3M/C camera specifications

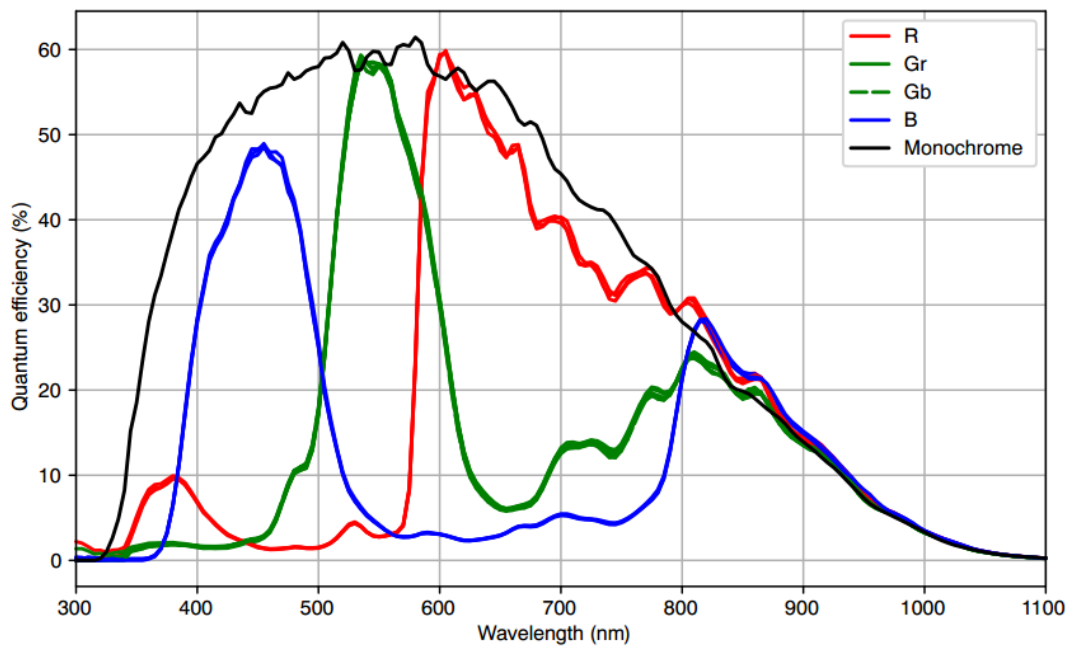

Figure 4-2 MARS-4470-8U3M/C sensor spectral response

## 5. Dimensions

### 5.1. Camera Dimensions

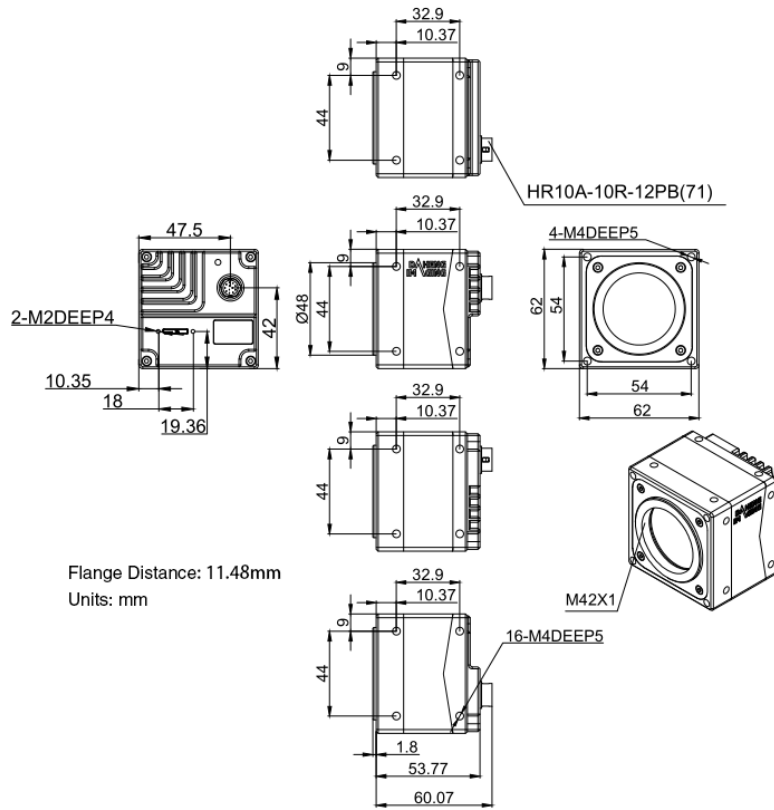

Figure 5-1 MARS-3250/4470-U3 (M42 mount) mechanical dimensions

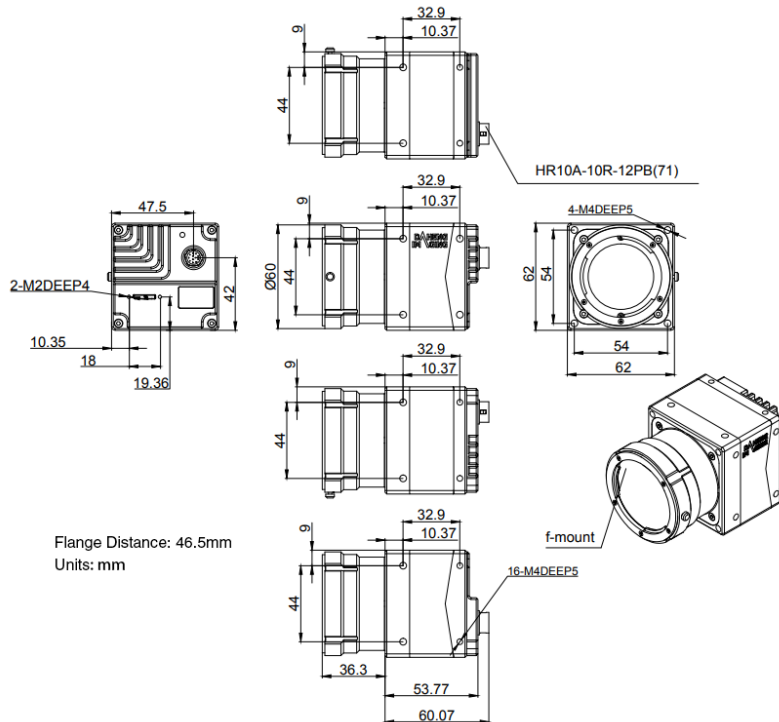

Figure 5-2 MARS-3250/4470-U3 (F mount) mechanical dimensions

## 5.2. Optical Interface

The camera supports standard M42 mount. The distance from the M42 lens installation reference plane to the sensor photosensitive surface is 11.48mm (in air). As shown in Figure 5-3, the acceptable lens thread length for M42 mount should be less than 5.4mm.

The camera supports standard F mount. The distance from the installation reference plane of the F mount to the sensor photosensitive surface is 46.5mm (in air).

The color models are equipped with IR filters and the cut-off frequency is 700nm. The mono models are equipped with antireflective glasses. Remove color filter or antireflective glasses will defocus the image plane.

Contact our technical support when the glass needed to be removed.

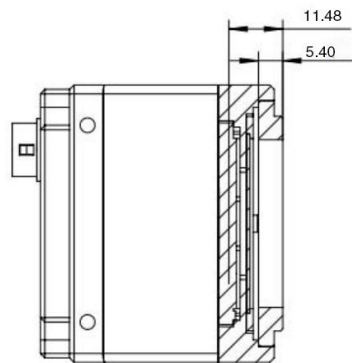

Figure 5-3 Optical interface of M42

## 5.3. Tripod Adapter Dimensions

When customizing the tripod adapter, you need to consider the relationship between tripod adapter, screw length and step thickness of tripod adapter.

- 1) Screw length = tripod adapter step thickness + spring washer thickness + screwing length of camera screw thread

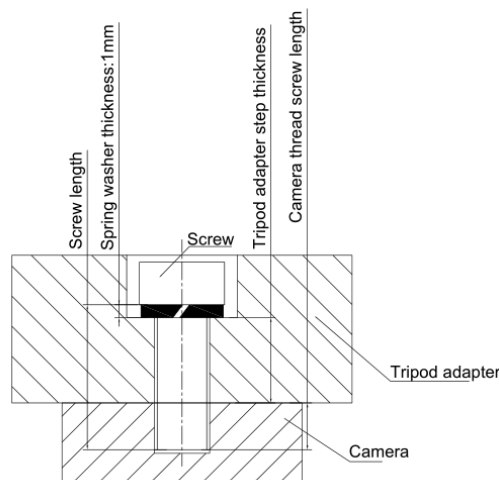

Figure 5-4 Schematic diagram of screw specification, tripod adapter step thickness and spring washer thickness

- 2) It is recommended that you select the screw specifications and the tripod adapter step thickness from the table below:

Screw specification	Tripod adapter step thickness (mm)	Spring washer thickness (mm)	Screwing length of camera screw thread (mm)
M4*8 screw	2.2	1	4.8
M4*10 screw	4.2	1	4.8



If the screw specification and the thickness of the tripod adapter do not conform to the above table, it may cause the camera thread hole through or thread stripping.

## 6. Filters and Lenses

### 6.1. Filters

The MARS color models are equipped with an IR filter. The thickness of the filter is  $0.7\pm 0.05\text{mm}$ , and the cut-off frequency is  $700\text{nm}$ , which reduces the influence of invisible light on the image. The monochrome models are equipped with a transparent glass. Remove IR-filter or transparent glass will defocus the image plane.

Contact our technical support when the glass needed to be removed.

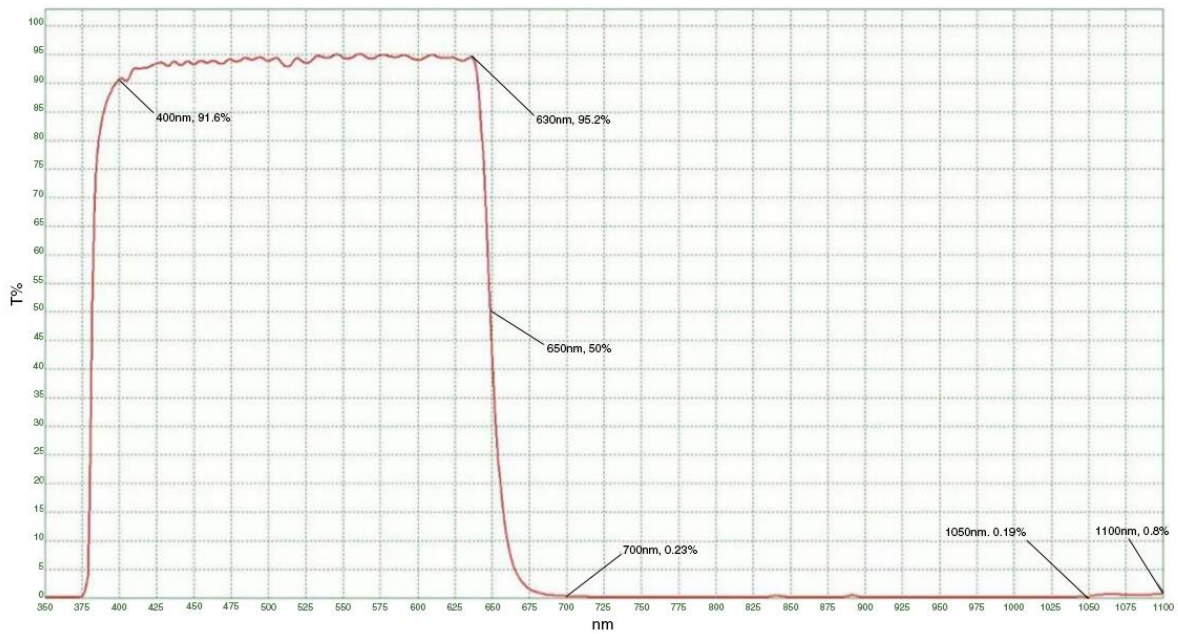

Figure 6-1 Infrared cut-off filter transmittance curve for MARS series color camera

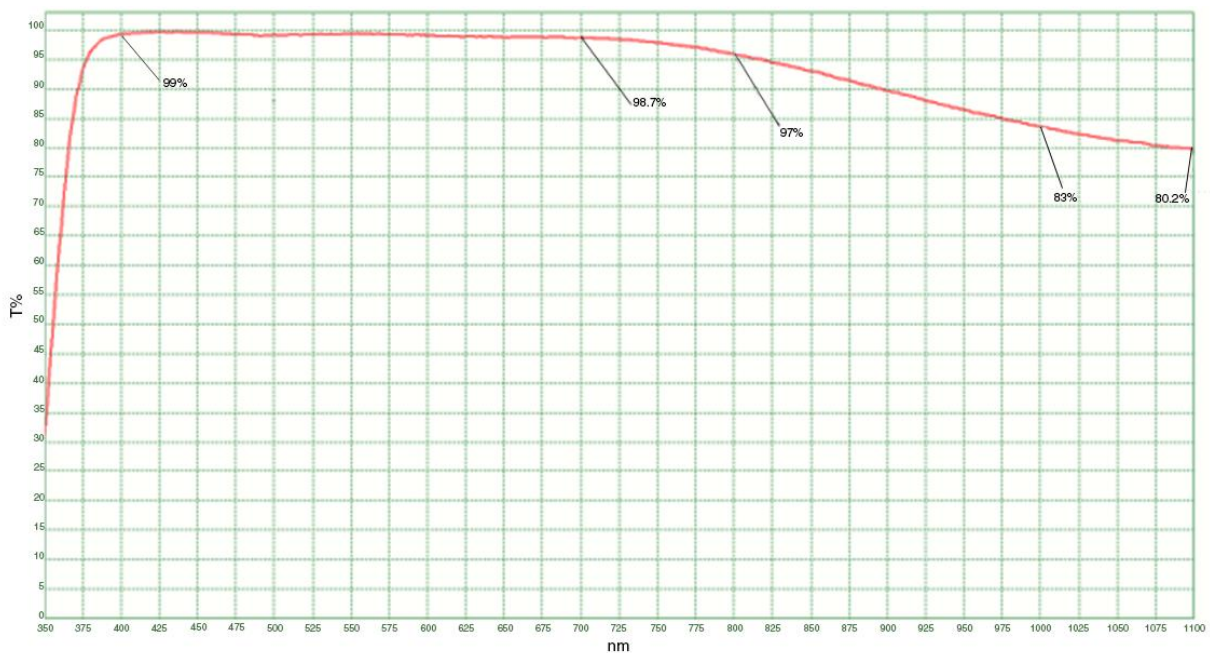

Figure 6-2 Transparent glass transmittance curve for MARS series mono camera

## 6.2. Lens Selection Reference

DAHENG IMAGING is a professional supplier for images and machine vision devices in China. In addition to industrial cameras, it also provides high-resolution, high-optical machine vision lenses for a wide range of industrial cameras on the market.

In order to meet the requirements of machine vision for high resolution and low distortion, DAHENG IMAGING released nine series of industrial lenses, resolution from 2 megapixels to 25 megapixels, with small size, light weight, high resolution and low distortion rate, etc.

When choosing a lens, there are several factors to consider:

### 1) Mount

- The lens and camera connection methods, commonly used mounts include C, CS, F, V, Leica, M42, M58, M72, M90, and so on
- The MARS series USB3.0 digital camera is equipped with a standard C-Mount. When selecting a lens, select the lens of the same mount as the camera

### 2) Max. Image Circle

- The maximum sensor size that the lens image can cover. There are mainly 1/2", 2/3", 1/1.2", 1", 1.1", 4/3", and so on
- When selecting a lens, make sure that the max. image circle of the lens is not smaller than the sensor size of the digital camera

### 3) Resolution

- The resolution represents the ability of the lens to record the details of the object, usually in units of line pairs that can be resolved per millimeter: line pair/mm (lp/mm). The higher the resolution of the lens, the sharper the image
- When selecting a lens, make sure that the accuracy required by the system is less than the resolution of the lens

### 4) Working distance

- The distance from the first working surface of the lens to the object being measured
- When selecting a lens, make sure that the working distance is larger than the lens parameter "minimum object distance"

### 5) Focal length

- The focal length is the distance from the center point of the lens to the clear image formed on the focal plane. The smaller the focal length, the larger the field of view of the digital camera
- For focal length calculation, we need to confirm three parameters: the field of view, the COMS size of the digital camera and the working distance. The focal length (f) of the expected lens can be calculated



by the following formula

$f = \text{sensor size (horizontal or vertical)} * \text{Working distance} / \text{Field of View (corresponding to the horizontal or vertical direction of the sensor size)}$

The corresponding lens is selected by the calculated focal length.

### 6.2.1. HN-2M Series

The HN-2M series lenses are 2 megapixels lenses for industrial, suitable for sensors with max. image circle of 1/2" ~ 2/3". This series of lenses has the following features:

- High optical performance with optical design supporting up to 2/3" sensor size, 6.2 $\mu$ m pixel size (up to 2 megapixels) sensor. 8 models with F values below 2.8, clear images can be obtained even in low light environment
- Excellent anti-shock and anti-vibration performance, with a unique mechanical structure, optical axis changes below 10 $\mu$ m
- The housing is small and compact, the minimum outer diameter is only  $\phi$ 29.5mm, and it can be installed in various limited spaces
- Easy to install, there are 3 fixing holes on the lens barrel for fixing the iris and focusing. The best fixing hole can be selected according to the installation environment

Models:

- HN-0612-2M-C1/2X
- HN-0914-2M-C2/3X
- HN-12.514-2M-C2/3X
- HN-1614-2M-C2/3X
- HN-2514-2M-C2/3X
- HN-3516-2M-C2/3X
- HN-5023-2M-C2/3X
- HN-7528-2M-C2/3X

### 6.2.2. HN-5M Series

The HN-5M series lenses are 5 megapixels lenses for industrial, suitable for sensors with max. image circle of 2/3" ~ 1.1". This series of lenses has the following features:

- 5 megapixels resolution, the definition is consistent from the center to the periphery, greatly improving the distance between iris and photography

- The housing is small and compact, the minimum outer diameter is only  $\phi 29.5\text{mm}$ , and it can be installed in various limited spaces
- Easy to install, there are 3 fixing holes on the lens barrel for fixing the iris and focusing. The best fixing hole can be selected according to the installation environment

Models:

- HN-0619-5M-C2/3X
- HN-0816-5M-C2/3X
- HN-1216-5M-C2/3X
- HN-1616-5M-C2/3X
- HN-2516-5M-C2/3X
- HN-3519-5M-C2/3X
- HN-5024-5M-C2/3X

### 6.2.3. HN-6M Series

The HN-6M series lenses are 6 megapixels lenses for industrial, suitable for sensors with max. image circle of 2/3". This series of lenses has the following features:

- 6 megapixels resolution, 5~75mm focal length available
- Stable performance at long working distance
- Compact and robust
- Up to 5G of anti-vibration performance

Models:

- HN-0528-6M-C2/3B
- HN-0828-6M-C2/3B
- HN-1228-6M-C2/3B
- HN-1628-6M-C2/3B
- HN-2528-6M-C2/3B
- HN-3528-6M-C2/3B
- HN-5028-6M-C2/3B
- HN-7528-6M-C2/3B

#### 6.2.4. HN-20M Series

The HN-20M series lenses are 20 megapixels lenses for industrial, suitable for sensors with max. image circle of 1". This series of lenses has the following features:

- 20 megapixels resolution, 8~75mm focal length available
- Ultra-low optical distortion and excellent uniformity of brightness
- Stable performance at different working distance by floating design
- The housing is small and compact, up to 5G of anti-vibration performance
- The definition is consistent from the center to the periphery, greatly improving the distance between iris and photography

Models:

- HN-0826-20M-C1/1X
- HN-1226-20M-C1/1X
- HN-1624-20M-C1/1X
- HN-2520-20M-C1/1X
- HN-3522-20M-C1/1X
- HN-5024-20M-C1/1X
- HN-7531-20M-C1/1X

#### 6.2.5. HN-P-6M Series

The HN-P-6M series lenses are 6 megapixels lenses for industrial, suitable for sensors with max. image circle of 1/1.8" ~ 2/3". This series of lenses has the following features:

- 6 megapixels resolution, 6~50mm focal length available
- The housing is small and compact, the minimum outer diameter is only  $\varphi 33.0\text{mm}$ , and it can be installed in various limited spaces
- Ultra-low optical distortion, greatly improving the accuracy and stability

Models:

- HN-P-0628-6M-C1/1.8
- HN-P-0828-6M-C1/1.8
- HN-P-1228-6M-C1/1.8
- HN-P-1628-6M-C1/1.8

- HN-P-2528-6M-C1/1.8
- HN-P-3528-6M-C1/1.8
- HN-P-5028-6M-C1/1.8
- HN-P-0828-6M-C2/3
- HN-P-1228-6M-C2/3
- HN-P-1628-6M-C2/3
- HN-P-2528-6M-C2/3
- HN-P-3528-6M-C2/3
- HN-P-5028-6M-C2/3

### 6.2.6. HN-P-10M Series

The HN-P-10M series lenses are 10 megapixels lenses for industrial, suitable for sensors with max. image circle of 2/3". This series of lenses has the following features:

- 10 megapixels resolution, 8~50mm focal length available
- 2.4 $\mu$ m small pixel size, F1.8 large aperture design
- The housing is small and compact, the minimum outer diameter is only  $\varphi$ 32.0mm, and it can be installed in various limited spaces
- Ultra-low optical distortion

Models:

- HN-P-0824-10M-C2/3
- HN-P-1220-10M-C2/3
- HN-P-1618-10M-C2/3
- HN-P-2518-10M-C2/3
- HN-P-3520-10M-C2/3
- HN-P-5028-10M-C2/3

### 6.2.7. HN-P-20M Series Prime Lenses

The HN-P-20M series lenses are 20 megapixels lenses for industrial, with max. image circle of 1.1". This series of lenses has the following features:

- 20 megapixels resolution, 12~50mm focal length available
- 2.4 $\mu$ m small pixel size, F2.4 large aperture design

- Miniaturized structure
- Ultra-low optical distortion

Models:

- HN-P-1224-20M-C1.1/1
- HN-P-1624-20M-C1.1/1
- HN-P-2524-20M-C1.1/1
- HN-P-3524-20M-C1.1/1
- HN-P-5024-20M-C1.1/1

### 6.2.8. HN-P-25M Series

The HN-P-25M series lenses are 25 megapixels lenses for industrial, suitable for sensors with max. image circle of 1.2". This series of lenses has the following features:

- 25 megapixels resolution, 12~50mm focal length available
- 2.74 $\mu$ m small pixel size, F2.4 large aperture design
- Small and compact
- Ultra-low optical distortion

Models:

- HN-P-1224-25M-C1.2/1
- HN-P-1624-25M-C1.2/1
- HN-P-2524-25M-C1.2/1
- HN-P-3524-25M-C1.2/1
- HN-P-5024-25M-C1.2/1

### 6.2.9. HN-P Series 8K ~ 16K Line Scan Lenses

Features of this series lenses are as follows:

- 8K ~ 16K resolution
- Focal length of 60mm
- 3.7 $\mu$ m ~ 7 $\mu$ m pixel size
- Magnification from 0.04 $\times$  to 0.05

Models:

- HN-P-6040-H
- HN-P-6040-L

## 7. Electrical Interface

### 7.1. LED Light

An LED light is set on the back cover of camera which indicates camera's status, as shown in Table 7-1. LED light can display 3 colors: red, yellow and green.

LED status	Camera status
Off	The camera is powered off or only the auxiliary power supply is powered on or only the USB3.0 interface is powered on
Solid red	The camera is not boot-loaded
Flashing red	The camera is in low power consumption mode
Solid green	The camera has been boot-loaded, but no data is being transmitted
Flashing green	Data is being transmitted
Flashing yellow	The camera's initialization failed

Table 7-1 Camera status

### 7.2. USB Port

Recommend to use the cables officially recognized by USB IF.

### 7.3. I/O Port

#### 7.3.1. I/O Port Definition

I/O port is implemented by Hirose 12-pin receptacle (No. HR10A-10R-12PB (71)), and the corresponding plug is HR10A-10P-12S(73).

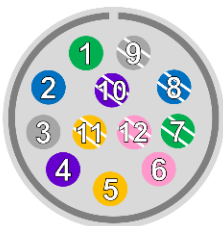
Diagram	Pin	Definition	Core Color	Description
	1	Line0+	Green	Opto-isolated input +
	2	GND	Blue	GPIO GND
	3	Line0-	Grey	Opto-isolated input -
	4	POWER_IN	Purple	Camera external power +12V (-10%) ~ +24V (+10%)
	5	Line2	Orange	GPIO input/output
	6	Line3	Pink	GPIO input/output
	7	Line1-	White Green	Opto-isolated output -
	8	Line1+	White Blue	Opto-isolated output +
	9	NC1	White Grey	Not connected, reserved

	10	GND	White Purple	GPIO GND
	11	NC2	White Orange	Not connected, reserved
	12	NC3	White Pink	Not connected, reserved

Table 7-2 I/O port definition (back sight of the camera)



The polarity of GPIO pins cannot be reversed, otherwise, camera or other peripherals could burn out.

### 7.3.2. I/O Electrical Characteristics

#### 7.3.2.1. Line0 (Opto-isolated Input) Circuit

Hardware schematics of opto-isolated input circuit is shown as Figure 7-1.

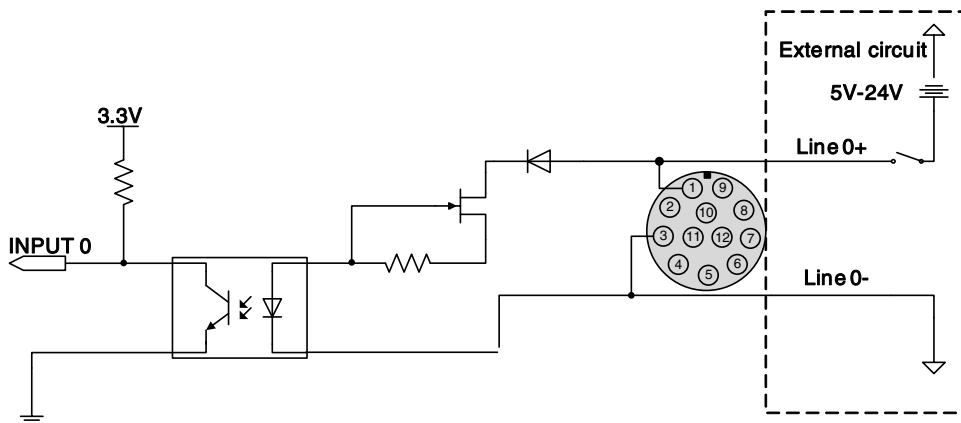

Figure 7-1 Opto-isolated input circuit

- Logic 0 input voltage: 0V~+2.5V (Line0+ voltage)
- Logic 1 input voltage: +5V~+24V (Line0+ voltage)
- Minimum input current: 7mA
- The status is unstable when input voltage is between 2.5V and 5V, which should be avoided
- When the external input voltage is 5V, there is no need for circuit-limiting resistance in the external input. But if there is a series resistance, please ensure the value is less than 90Ω. In order to protect the Line0+ while the external input voltage is higher than 9V, a circuit-limiting resistance is needed in the external input. The recommended resistance is shown in Table 7-3

External input voltage	Circuit-limiting resistance R <sub>limit</sub>	Line0+ input voltage
5V	Non or <90Ω	About 5V
9V	680Ω	About 5.5V
12V	1kΩ	About 6V
24V	2kΩ	About 10V

Table 7-3 Circuit-limiting resistor value



The connection method of the opto-isolated input circuit and the NPN and PNP photosensor is shown in Figure 7-2 and Figure 7-3. The relationship between the pull-up resistor and the external power supply voltage is shown in Table 7-3.

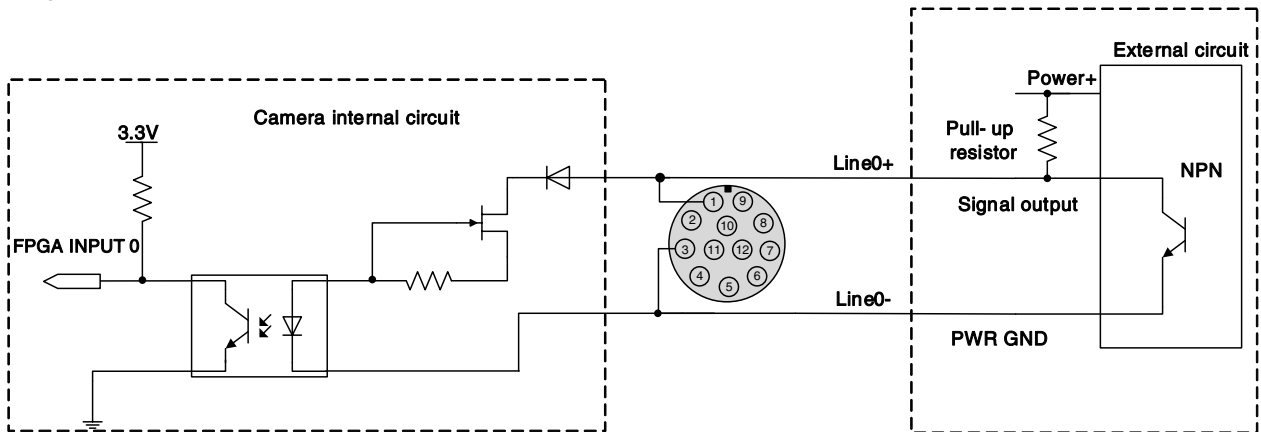

Figure 7-2 NPN photosensor connected to opto-isolated input circuit

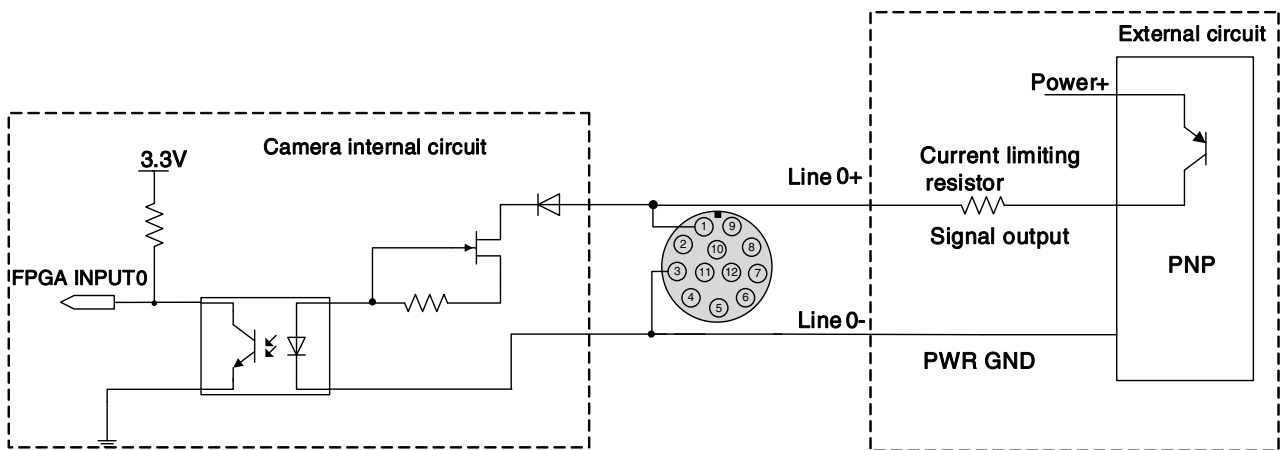

Figure 7-3 PNP photosensor connected to opto-isolated input circuit

- Rising edge delay: <math><50\mu\text{s}</math> ( $0^{\circ}\text{C}\sim 45^{\circ}\text{C}</math>), parameter description as shown in Figure 7-4$
- Falling edge delay: <math><50\mu\text{s}</math> ( $0^{\circ}\text{C}\sim 45^{\circ}\text{C}</math>), parameter description as shown in Figure 7-4$
- Different environment temperature and input voltage have influence on delay time of opto-isolated input circuit. Delay times in typical application environment (temperature is  $25^{\circ}\text{C}</math>) is as shown in Table 7-4$

Parameter	Test condition	Value ( $\mu\text{s}$ )		
Rising edge delay	VIN=5V	3.02	~	6.96
	VIN=12V	2.46	~	5.14
Falling edge delay	VIN=5V	6.12	~	17.71
	VIN=12V	8.93	~	19.73

Table 7-4 Delay time of opto-isolated input circuit in typical application environment

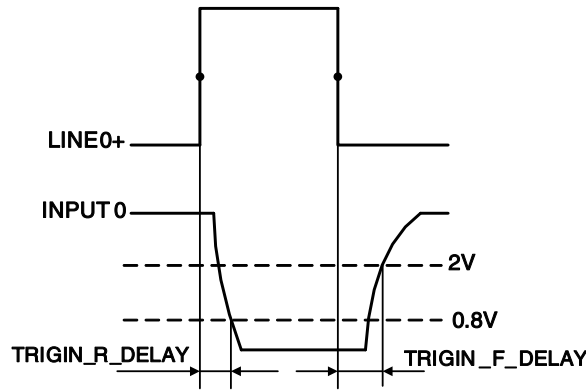

Figure 7-4 Parameter of opto-isolated input circuit

- Rising time delay (TRIGIN\_R\_DELAY): the time required for the response to the decrease to 0.8V of INPUT0 from 50% rising of LINE0+
- Falling time delay (TRIGIN\_F\_DELAY): the time required for the response to the rise to 2V of INPUT0 from 50% falling of LINE0+

7.3.2.2. Line1 (Opto-isolated Output) Circuit

Hardware schematics of opto-isolated output circuit is shown as Figure 7-5.

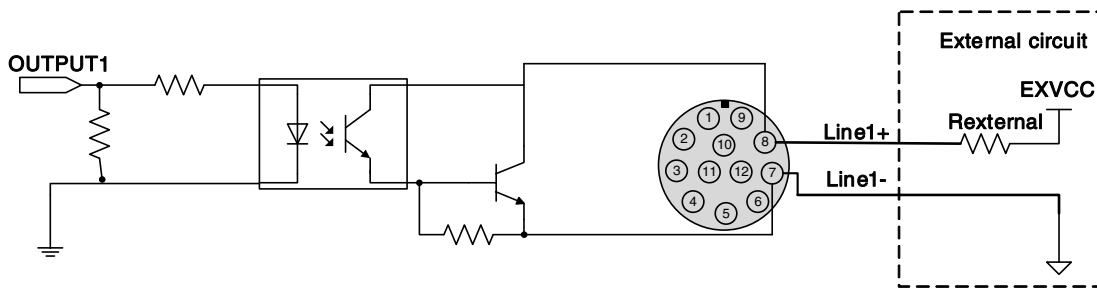

Figure 7-5 Opto-isolated output circuit

- Range of external voltage (EXVCC) is 5~24V
- Maximum output current of Line1 is 25mA
- Transistor voltage drop and output current of opto-isolated output circuit in typical application environment (temperature is 25°C) is as shown in Table 7-5

External voltage EXVCC	External resistance Rexternal	Transistor voltage drop (turn on, unit V)	Output current (mA)
5V	1kΩ	0.90	4.16
12V	1kΩ	0.97	11.11
24V	1kΩ	1.04	23.08

Table 7-5 Transistor voltage drop and output current of opto-isolated output circuit in typical application environment

- Rising time delay = tr+td: <50μs (0°C~45°C) (parameter description is shown in Figure 7-6)
- Falling time delay = ts+tf: <50μs (0°C~45°C) (parameter description is shown in Figure 7-6)

- Delay time in typical application conditions (environment temperature is 25°C) are shown in Table 7-6

Parameter	Test Condition	Value (μs)		
Storage time (ts)	External power is 5V, pull-up resistor is 1kΩ	6.16	~	13.26
Delay time (td)		1.90	~	3.16
Rising time (tr)		2.77	~	10.60
Falling time (tf)		7.60	~	11.12
Rising time delay = tr+td		4.70	~	13.76
Falling time delay = tf+ts		14.41	~	24.38

Table 7-6 Delay time of opto-isolated output circuit in typical application environment

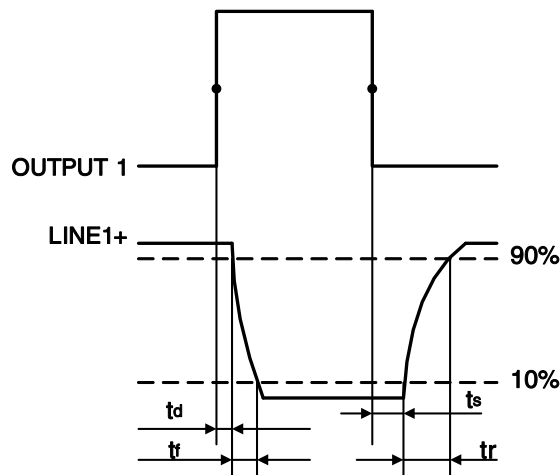

Figure 7-6 Parameter of opto-isolated output circuit

- Delay time (td): the time required from 50% rising of OUTPUT1 to the decrease to 90% of the maximum value of LINE1+
- Falling time (tf): the time taken for the amplitude of LINE1+ to decrease from 90% to 10% of the maximum value
- Storage time (ts): the time required from 50% falling of OUTPUT1 to the rise to 10% of the maximum value of LINE1+
- Rising time (tr): the time for the response of LINE1+ to rise from 10% to 90% of its final value
- Delay time in typical application conditions (environment temperature is 25°C) are shown in Table 7-7

Parameter	Test Condition	Value (μs)		
Storage time (ts)	External power is 5V, pull-up resistor is 1kΩ	6.16	~	13.26
Delay time (td)		1.90	~	3.16

Rising time ( $t_r$ )		2.77	~	10.60
Falling time ( $t_f$ )		7.60	~	11.12
Rising time delay = $t_r+t_d$		4.70	~	13.76
Falling time delay = $t_f+t_s$		14.41	~	24.38

Table 7-7 Delay time of opto-isolated output circuit in typical application environment

7.3.2.3. GPIO 2/3 (Bidirectional) Circuit

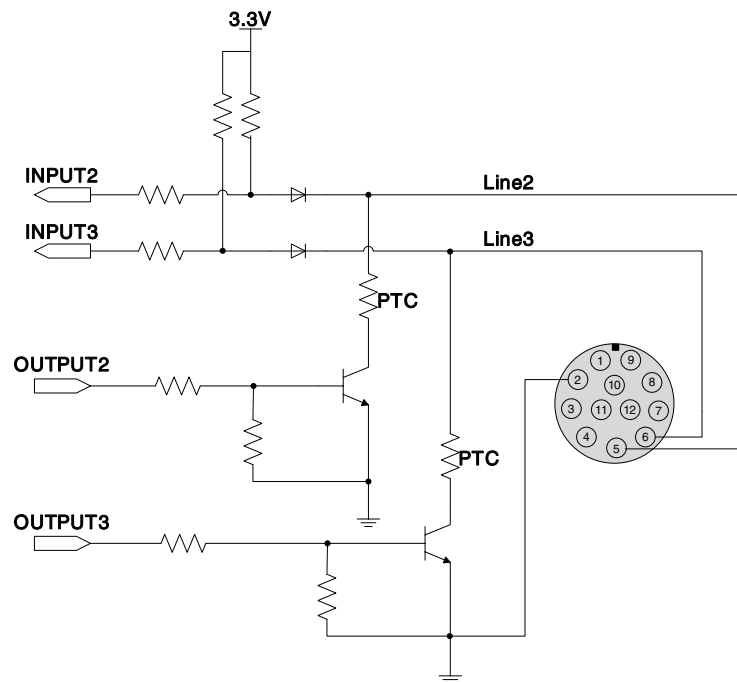

Figure 7-7 GPIO 2/3 (bidirectional) circuit

7.3.2.3.1. Line2/3 is Configured as Input

When Line2/3 is configured as input, the internal equivalent circuit of camera is shown in Figure 7-8, taking Line2 as an example.

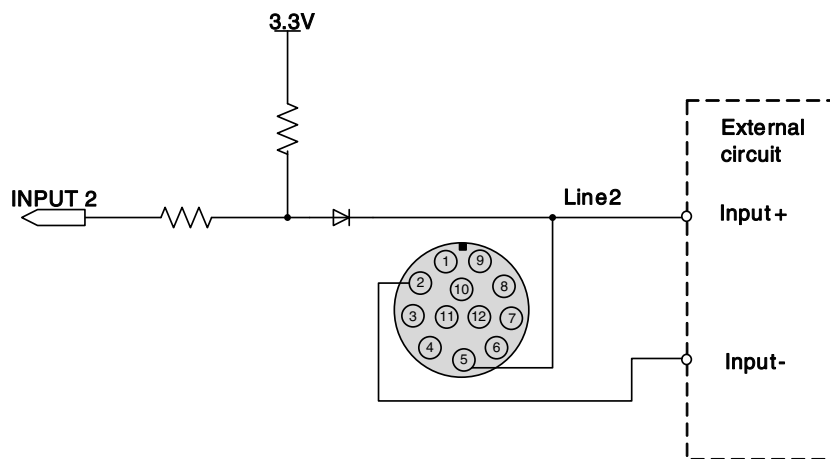

Figure 7-8 Internal equivalent circuit of camera when Line2 is configured as input



To avoid the damage of GPIO pins, please connect GND pin before supplying power to Line2/3.

- Logic 0 input voltage: 0V~+0.6V (Line2/3 voltage)
- Logic 1 input voltage: +1.9V~+24V (Line2/3 voltage)
- The status is unstable when input voltage is between 0.6V and 1.9V, which should be avoided
- When input of Line2/3 is high, input current is lower than 100μA. When input of Line2/3 is low, input current is lower than -1mA. When Line2/3 is configured as input. The connection method between them and NPN and PNP photoelectric sensors is shown in Figure 7-9 and Figure 7-10.

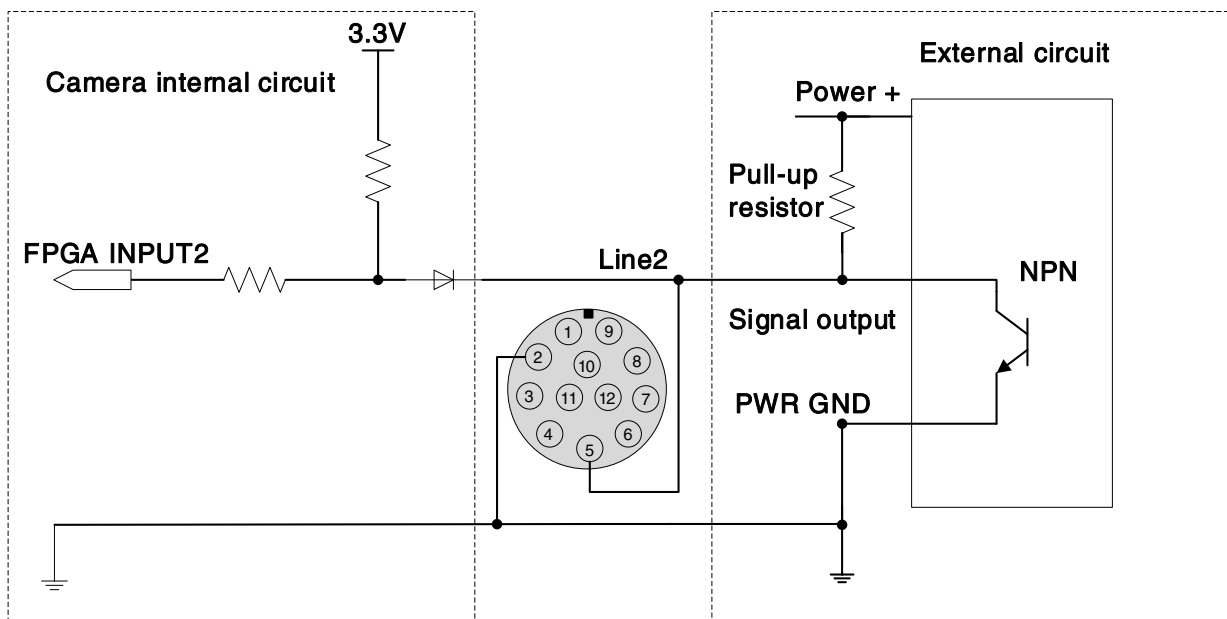

Figure 7-9 NPN photoelectric sensor connected to Line2 input circuit

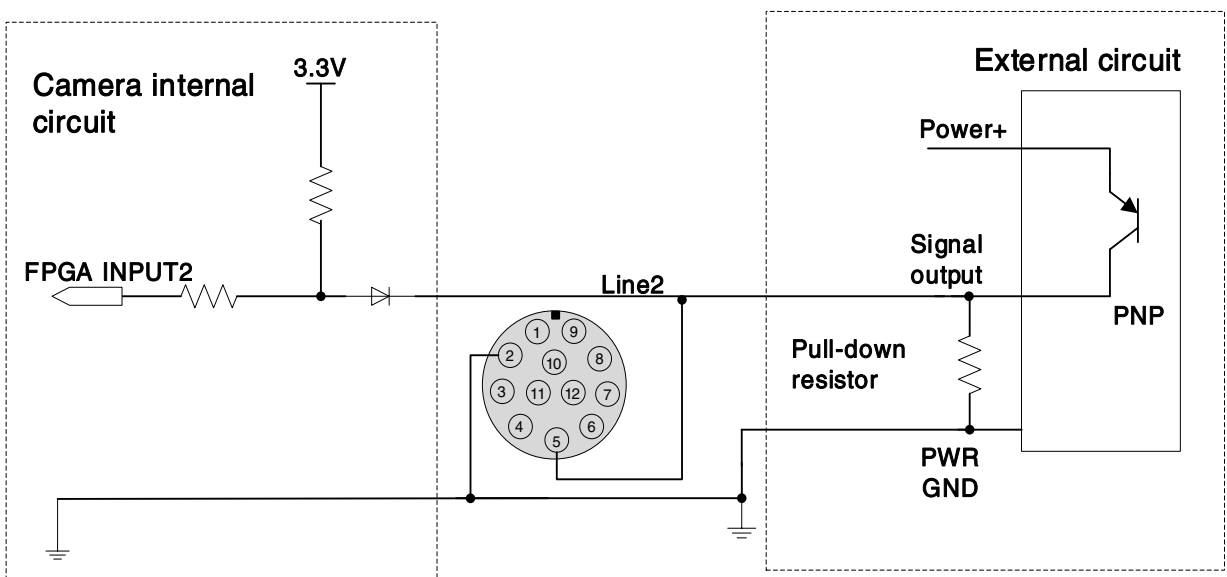

Figure 7-10 PNP photoelectric sensor connected to Line2 input circuit

- When Lline2/3 is configured as input, pull-down resistor over 1K should not be used, otherwise the input voltage of Line2/3 will be over 0.6V and logic 0 cannot be recognized stably.
- Input rising time delay:  $<2\mu\text{s}$  ( $0^{\circ}\text{C}\sim 45^{\circ}\text{C}$ ), parameter description as shown in Figure 7-11
- Input falling time delay:  $<2\mu\text{s}$  ( $0^{\circ}\text{C}\sim 45^{\circ}\text{C}$ ), parameter description as shown in Figure 7-11

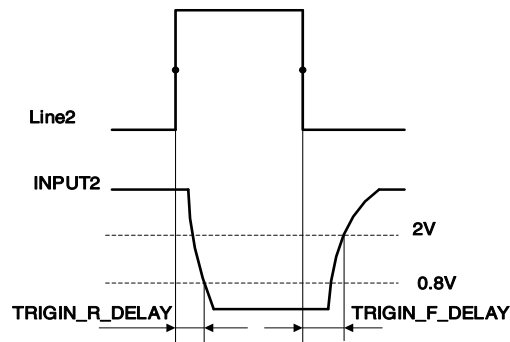

Figure 7-11 Circuit delay parameter when Line2 is configured as an input

7.3.2.3.2. Line2/3 is Configured as Output

- Range of external voltage (EXVCC) is 5~24V
- Maximum output current of Line2/3 is 25mA, output impedance is  $40\Omega$
- Transistor voltage drop and output current in typical application conditions (temperature is  $25^{\circ}\text{C}$ ) are shown in Table 7-8.

External voltage EXVCC	External resistance Rexternal	Transistor voltage drop (turn on, unit V)	Output current (mA)
5V	1k $\Omega$	0.19	4.8
12V		0.46	11.6
24V		0.92	23.1

Table 7-8 Transistor voltage drop and output current of Line2/3 in typical conditions

- Rising time delay =  $t_r+t_d$ :  $<20\mu\text{s}$  ( $0^{\circ}\text{C}\sim 45^{\circ}\text{C}$ ) (parameter description as shown in Figure 7-12)
- Falling time delay =  $t_s+t_f$ :  $<20\mu\text{s}$  ( $0^{\circ}\text{C}\sim 45^{\circ}\text{C}$ ) (parameter description as shown in Figure 7-12)

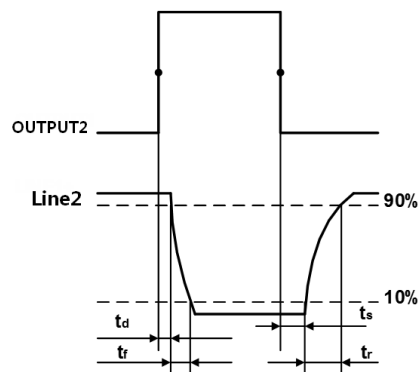

Figure 7-12 Line2 output circuit parameters

- Delay time (td): the time required from 50% rising of OUTPUT2 to the decrease to 90% of the maximum value of LINE2
- Falling time (tf): the time taken for the amplitude of LINE2 to decrease from 90% to 10% of the maximum value
- Storage time (ts): the time required from 50% falling of OUTPUT2 to the rise to 10% of the maximum value of LINE2
- Rising time (tr): the time for the response of LINE2 to rise from 10% to 90% of its final value
- Delay parameters are affected greatly by external voltage and external pull-up resistor, but little by temperature. Output delay time in typical application conditions (temperature is 25°C) are shown in Table 7-9.

Parameter	Test Conditions	Value (μs)		
Storage time (ts)	External power is 5V, pull-up resistor is 1kΩ	0.17	~	0.18
Delay time (td)		0.08	~	0.09
Rising time (tr)		0.11	~	0.16
Falling time (tf)		1.82	~	1.94
Rising time delay = tr+td		0.19	~	0.26
Falling time delay = tf+ts		1.97	~	2.09

Table 7-9 Delay time when GPIO is configured as output in typical conditions

- When Line2/3 is configured as output, the internal equivalent circuit of camera is shown in Figure 7-13, taking Line2 as an example.

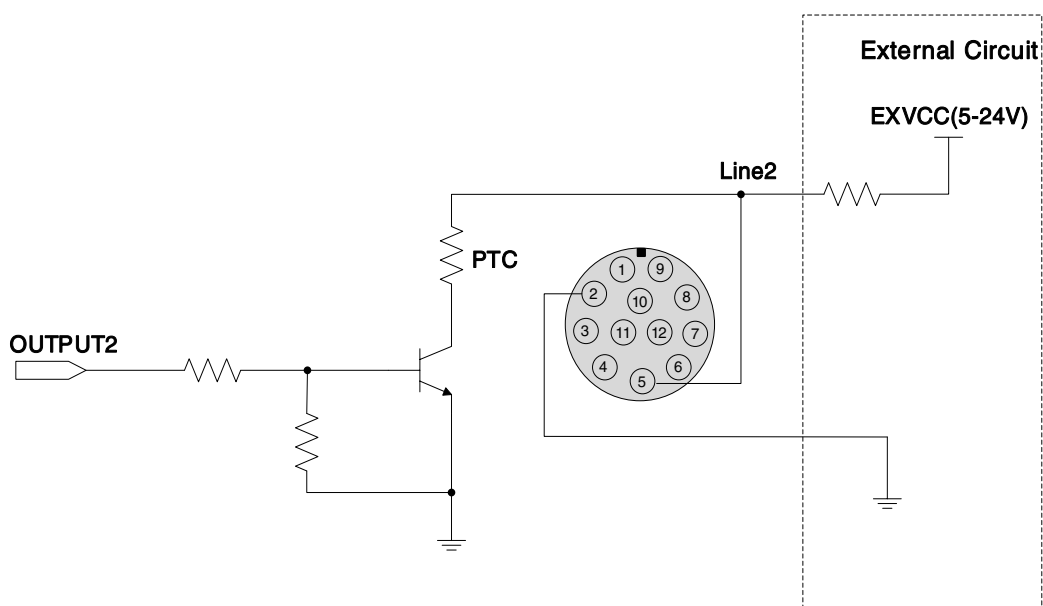

Figure 7-13 Internal equivalent circuit of camera when Line2 is configured as output

## 8. Features

MARS USB3 Vision camera supports a variety of standard and advanced functions. The function support of different models varies slightly. Please refer to the DAHENG Cameras Feature List for details.

### 8.1. I/O Control

#### 8.1.1. Input Mode Operation

##### 1) Configuring Line as input

The MARS-U3 series camera has three input signals: Line0, Line2, and Line3. In which the Line0 is un-directional opto-isolated input, Line2 and Line3 are bi-directional lines which can be configured as input or output.

The camera's default input is Line0 when the camera is powered on. Line2 and Line3 are input by default, which can be configured to be input or output by LineMode.

##### 2) Input Debouncer

In order to suppress the interference signals from hardware trigger, the MARS-U3 series camera has the hardware trigger filtering feature, including rising edge filtering and falling edge filtering. The user can set the trigger filter feature by setting the "TriggerFilterRaisingEdge" and the "TriggerFilterFallingEdge". The range of the trigger filter feature is [0, 5000]  $\mu$ s, step: 1 $\mu$ s.

Example 1: Setting the rising edge filter width to 1ms, the pulse width less than 1ms in the rising edge will be filtered out, as shown in Figure 8-1:

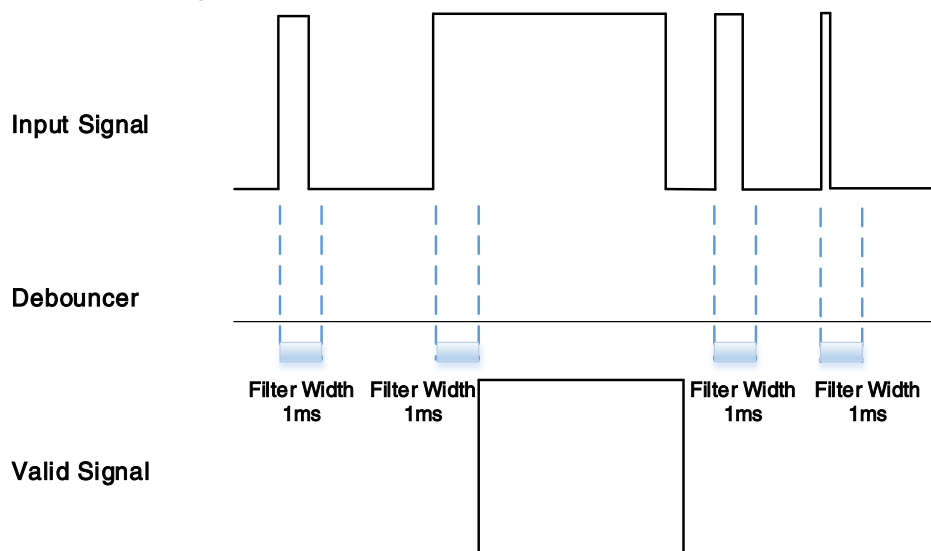

Figure 8-1 Input debouncer schematic diagram

##### 3) Trigger Delay

The MARS-U3 series camera has trigger delay feature. The user can set the trigger delay feature by setting "TriggerDelay". The range of the trigger delay feature is [0, 3000000]  $\mu$ s, step: 1 $\mu$ s.



Example 1: Setting the trigger delay value to 1000ms, and the trigger signal will be valid after 1000ms delay, as shown in Figure 8-2.

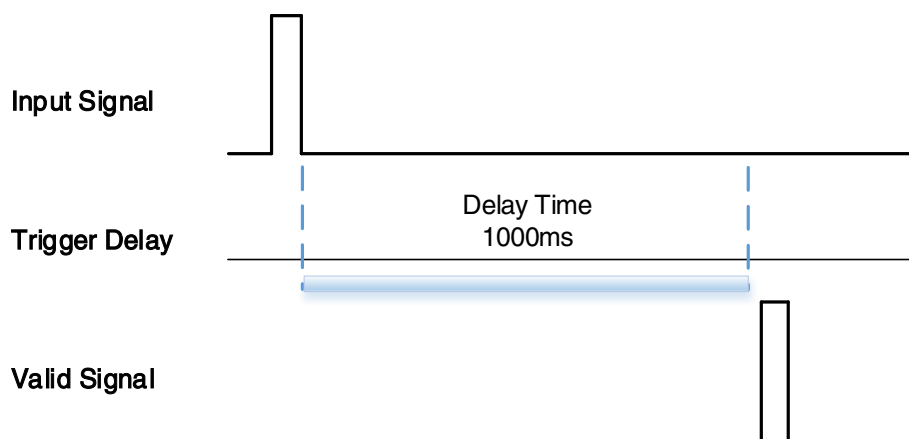

Figure 8-2 Trigger delay schematic diagram

#### 4) Input Inverter

The signal level of input lines is configurable for the MARS-U3 series camera. The user can select whether the input level is reverse or not by setting "LineInverter".

For the MARS-U3 series camera, the default input line level is false when the camera is powered on, indicating that the input line level is not reversed. If it is set as true, indicating that the input line level is reversed. As shown in the Figure 8-3:

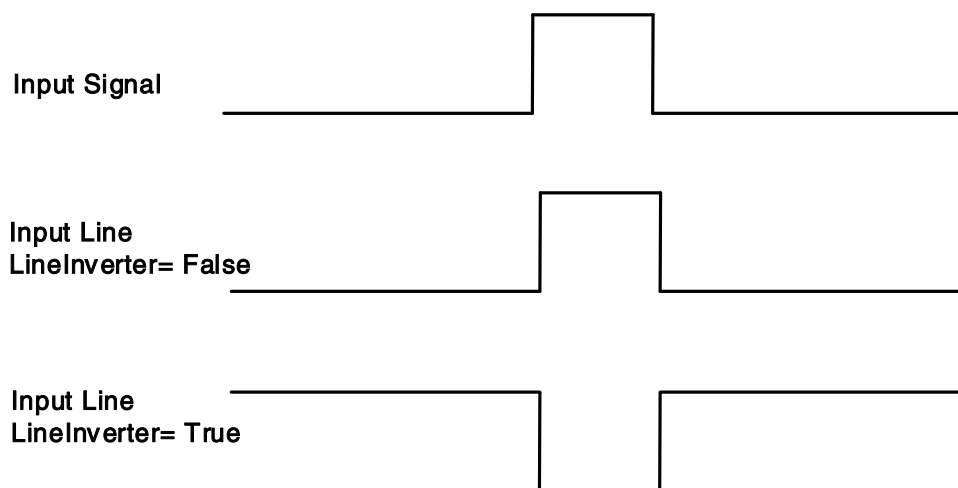

Figure 8-3 Setting input line to reverse

### 8.1.2. Output Mode Operation

#### 1) Configuring Line as output

The MARS-U3 series camera has three output signals: Line1, Line2, and Line3. In which the Line1 is a un-directional opto-isolated output I/O, Line2 and Line3 are bi-direction configurable I/Os.

The camera's default output is Line1 when the camera is powered on. Line2 and Line3 can be configured to be output by changing the "LineMode" of this line.

Each output source of the three output lines is configurable, and the output source includes: Strobe, UserOutput0, UserOutput1, UserOutput2.

The default output source of the camera is UserOutput0 when the camera is powered on.

What status (high or low level) of the output signal is valid depends on the specific external circuit. The following signal diagrams are described as examples of active low.

- Strobe

In this mode the camera sends a trigger signal to activate the strobe. The strobe signal is active low. After receiving the trigger signal, the strobe signal level is pulled low, and the pull-low time is the sum of the exposure delay time and the exposure time.

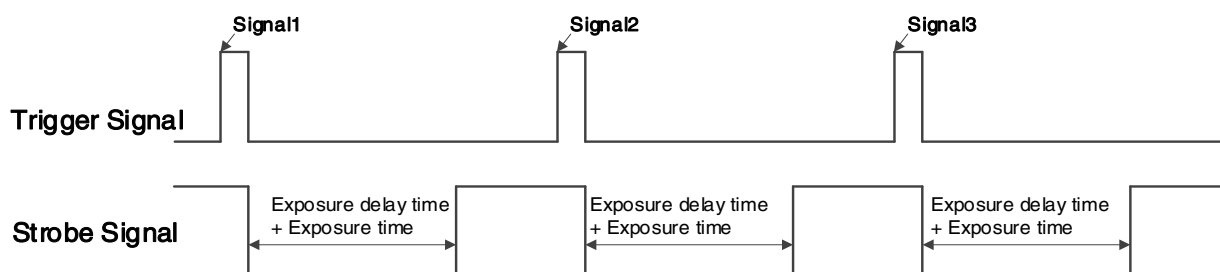

Figure 8-4 Strobe signal schematic diagram

- UserOutput

In this mode, the user can set the camera's constant output level for special processing, such as controlling the constant light source or the alarm light (two level types are available: high level or low level).

For example: select line2 as the output line, the output source is selected as UserOutput1, and the output value is defined as true.

"LineSelector" is selected as "line2", "LineMode" is set to "Output", "LineSource" is set to "UserOutput1", "UserOutputSelector" is selected as "UserOutput1", and "UserOutputValue" is set to "true".

- ExposureActive

You can use the "ExposureActive" signal to check whether the camera is currently exposing. The signal goes low at the beginning of the exposure and the signal goes high at the end of the exposure. For electronic rolling shutter cameras, the signal goes low when the exposure of the last line ends.

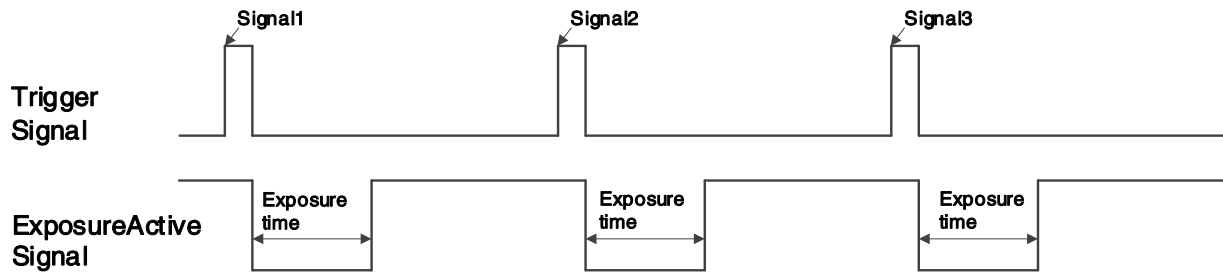

Figure 8-5 Global shutter "ExposureActive" signal schematic diagram

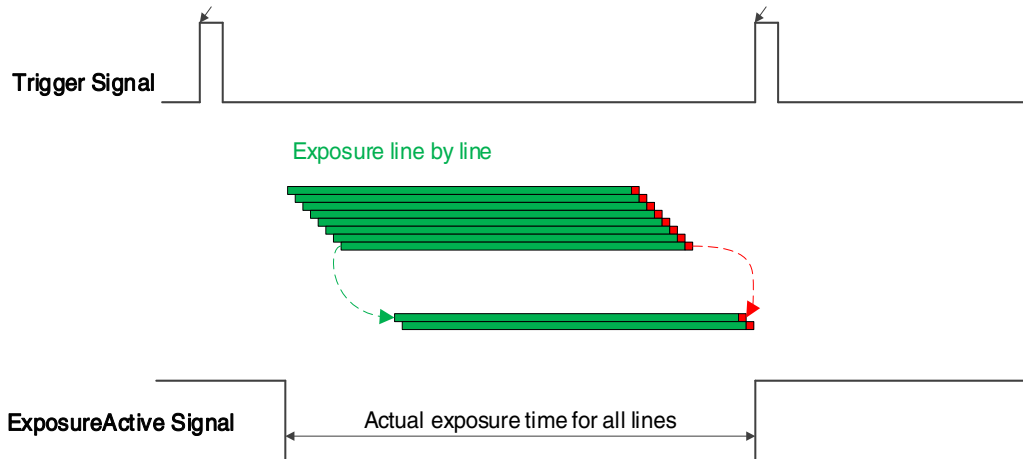

Figure 8-6 Electronic rolling shutter mode (non-overlapping exposure) "ExposureActive" signal schematic diagram

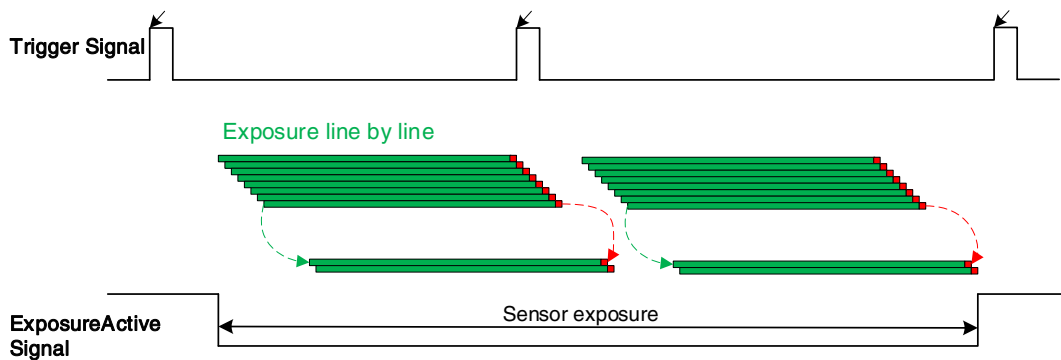

Figure 8-7 Electronic rolling shutter mode (overlapping exposure) "ExposureActive" signal schematic diagram

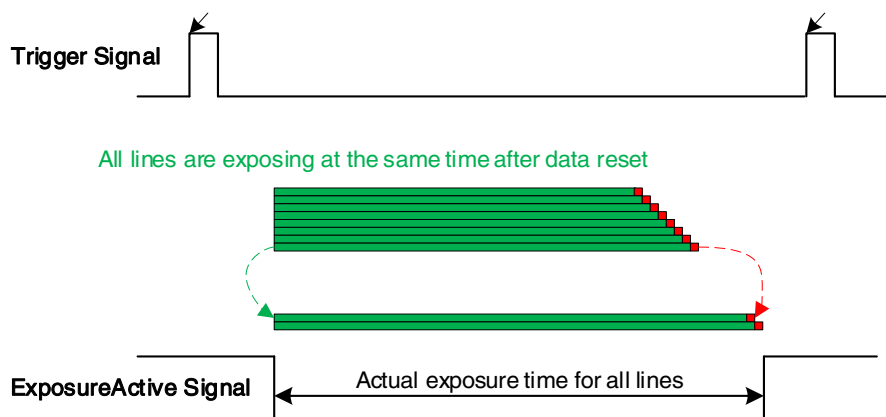

Figure 8-8 Global reset release shutter mode "ExposureActive" signal schematic diagram

This signal is useful when the camera or target object is moving. For example, suppose the camera is mounted on a robotic arm that can move the camera to different position. Generally, it is not desirable for the camera to move during the exposure. In this case, you can check the exposure activity signal to know the exposure time so you can avoid moving the camera during this time.

- TriggerWait

The "TriggerWait" signal can be used to optimize the acquisition of the trigger image and to avoid excessive triggering.

It is recommended to use the "TriggerWait" signal only when the camera is configured for hardware trigger. For software trigger, please use the "AcquisitionStatus". When the camera is ready to receive a trigger signal of the corresponding trigger mode, the "TriggerWait" signal goes low. When the corresponding trigger signal is used, the "TriggerWait" signal goes high. It remains high until the camera is ready to receive the next trigger.

When the trigger mode is "FrameStart", the camera acquires only one frame of image when it receives the trigger signal. After receiving the trigger signal, the "FrameTriggerWait" signal is pulled low and the camera starts exposure transmission. After the transfer is complete, the "FrameTriggerWait" signal is pulled high.

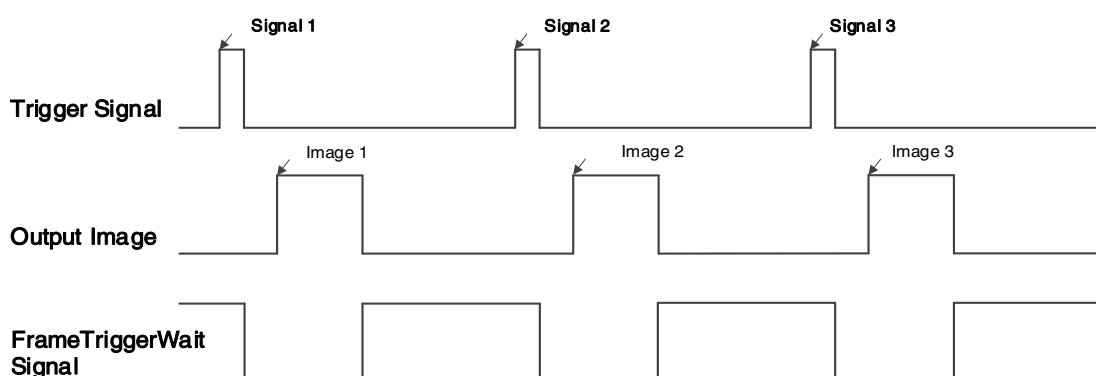

Figure 8-9 "FrameTriggerWait" signal schematic diagram

When the trigger mode is "FrameBurstStart", each time the camera receives a trigger signal, it will acquire the set AcquisitionFrameCount frames of image. After receiving the trigger signal, the "AcquisitionTriggerWait" signal is pulled low and the camera starts the exposure transmission. When the transmission is completed and images are transferred, the "AcquisitionTriggerWait" signal will be pulled high.

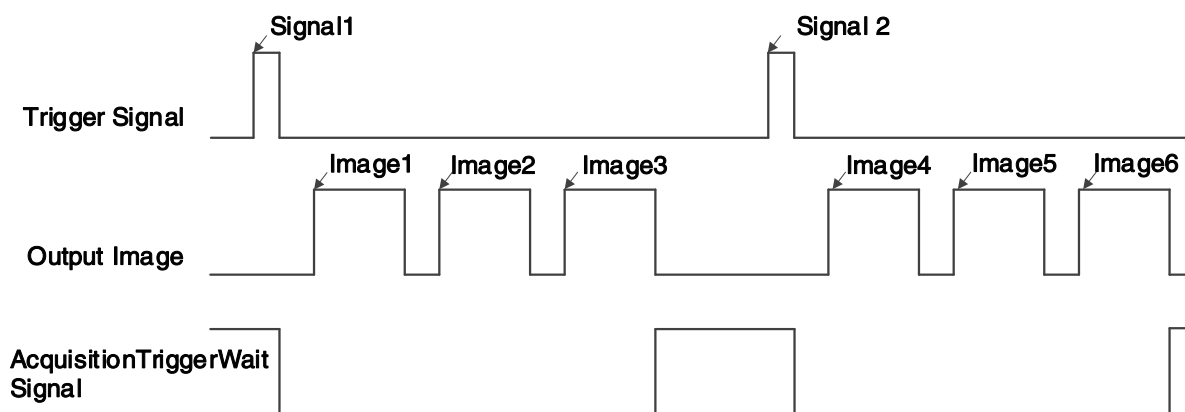

Figure 8-10 "AcquisitionTriggerWait" signal schematic diagram

When the trigger mode is "FrameBurstStart" ("FrameStart" mode is on), if the high-speed burst frames is set to 3, the camera will first send a "FrameBurstStart" trigger signal. After receiving the trigger signal, the "AcquisitionTriggerWait" signal is pulled low. Then three "FrameStart" trigger signals need to be sent continuously. Each time the camera receives a trigger signal, it transmits one frame image. After receiving the trigger signal, the "FrameTriggerWait" signal is pulled low and the camera will start exposure transmission. The "FrameTriggerWait" signal will be pulled high after the transmission is completed. Only the first 3 FrameStart trigger signals are valid. When the transmission is completed, the "AcquisitionTriggerWait" signal will be pulled high.

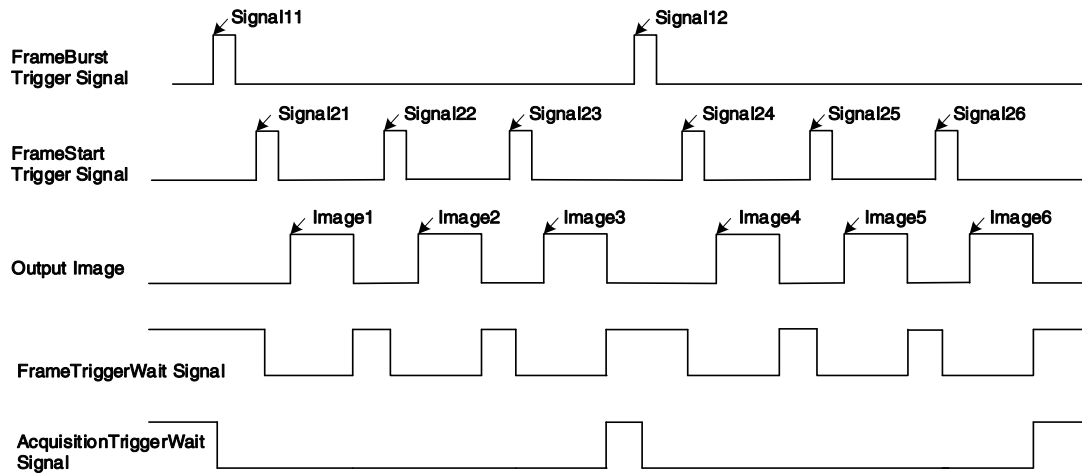

Figure 8-11 "TriggerWait" signal schematic diagram when "FrameBurstStart" and "FrameStart" enabled simultaneously

2) Setting the user-defined status for the output lines

The MARS-U3 series camera can select the user-defined output by setting "LineSource", by setting "UserOutputValue" to configure the output signal.

By setting "UserOutputSelector" to select UserOutput0, UserOutput1 or UserOutput2.

By setting "UserOutputValue" to set the user-defined output value, and the default value is false when the camera is powered on.

3) Output Inverter

In order to facilitate the camera I/O configuration and connection, the MARS-U3 series camera can configure output signal level. The user can select whether the output level is reverse or not by setting "LineInverter".

The default output signal level is false when the camera is powered on, indicating that the output line level is not reversed. If it is set as true, indicating that the output line level is reversed. As shown in the Figure 8-12.

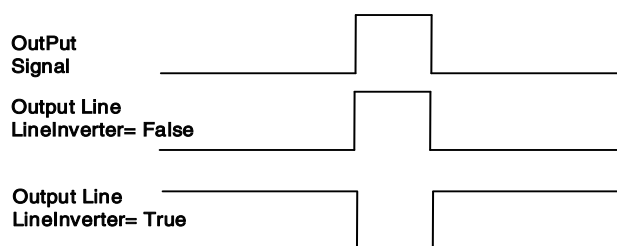

Figure 8-12 Set output line reversion

### 8.1.3. Read the LineStatus

#### 1) Read the level of single line

The MARS-U3 series camera can get the line's signal status. When the device is powered on, the default status of Line0 is false, and the default status of Line1, Line2 and Line3 is true.

#### 2) Read all the lines level

The MARS-U3 series camera can get the current status of all lines. On the one hand, the signal status is the status of the external I/O after the reversal of the polarity. On the other hand, signal status level can reflect the external I/O level.

All the lines level status bit of the MARS-U3 series camera are shown in Table 8-1. The default polarity does not reverse, and the default value is 0xE.

Line3	Line2	Line1	Line0
1	1	1	0

Table 8-1 Camera line status bit

## 8.2. Image Acquisition Control

### 8.2.1. Acquisition Start and Stop

#### 8.2.1.1. Acquisition Start

It can send **AcquisitionStart** command immediately after opening the camera. The acquisition process in continuous mode is illustrated in Figure 8-13, and the acquisition process in trigger mode is illustrated in Figure 8-14.

- **Continuous Acquisition**

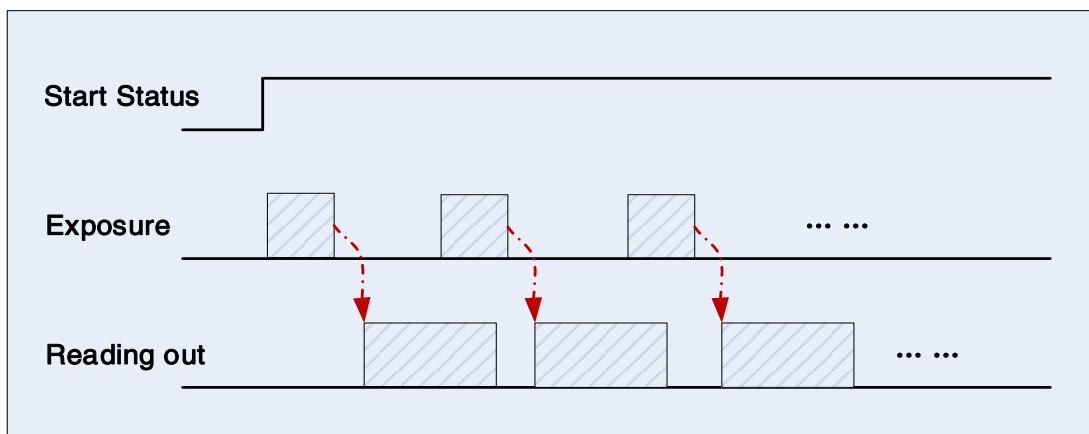

Figure 8-13 Continuous acquisition process

In continuous mode, a camera starts to expose and read out after receiving the **AcquisitionStart** command. The frame rate is determined by the exposure time, ROI and some other parameters.

- Trigger Acquisition

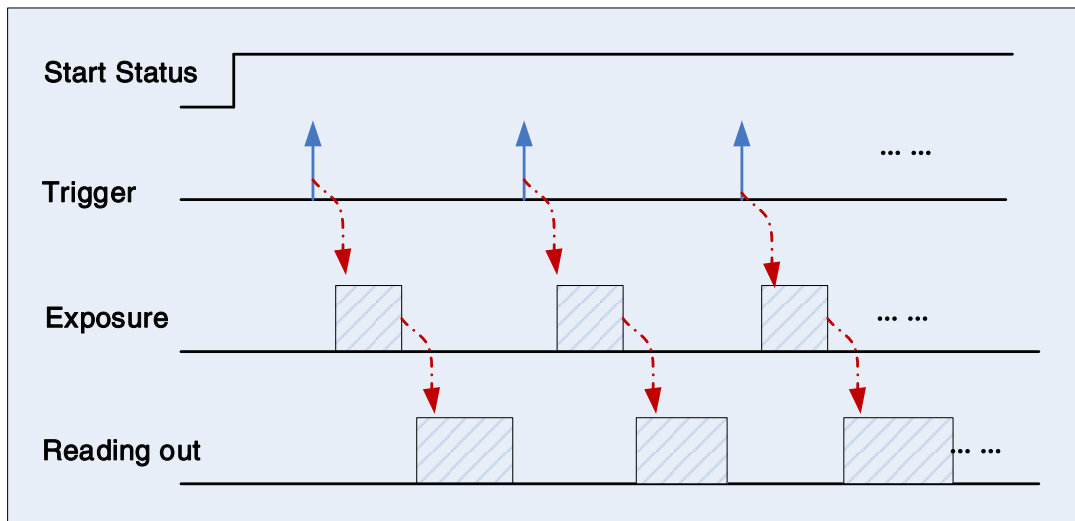

Figure 8-14 Trigger acquisition process

In trigger mode, sending **AcquisitionStart** command is not enough, a trigger signal is also needed. Each time a frame trigger is applied (including software trigger and hardware trigger), the camera will acquire and transmit a frame of image.

### 8.2.1.2. Acquisition Stop

It can send **AcquisitionStop** command to camera at any time. The acquisition stop process is irrelevant to acquisition mode. But different stop time will result in different process, as shown in Figure 8-15 and Figure 8-16.

- Acquisition stop during reading out

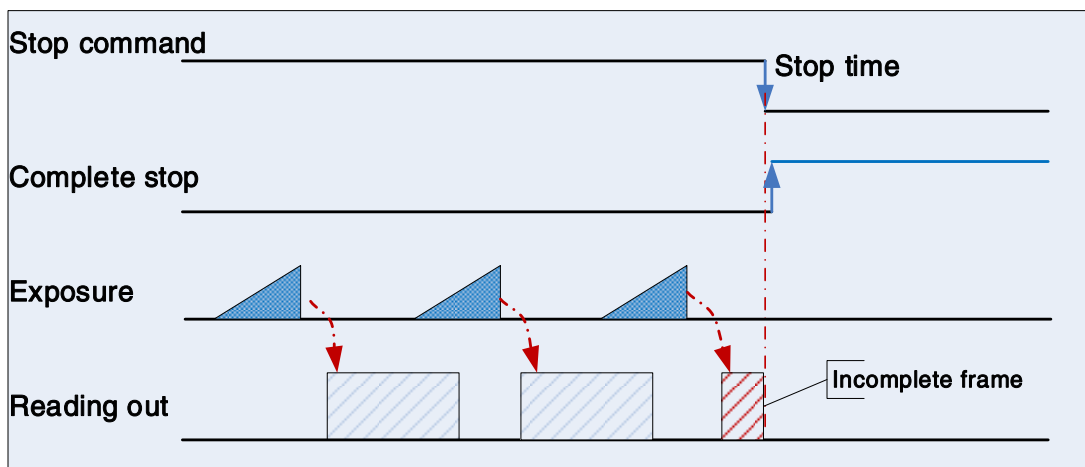

Figure 8-15 Acquisition stop during reading out

As shown in Figure 8-15, when the camera receives an **AcquisitionStop** command during reading out, it stops transferring frame data immediately. The currently transferred frame data is regarded as incomplete frame and will be discarded.

- Acquisition stop during blanking

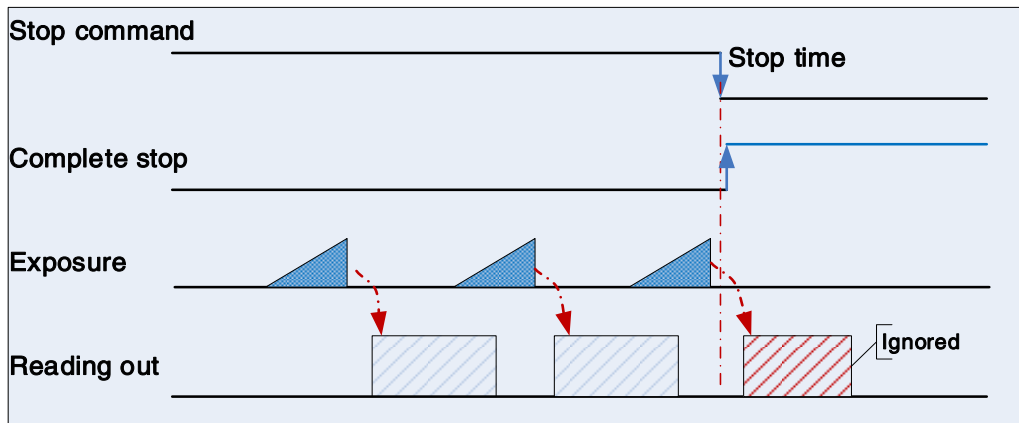

Figure 8-16 Acquisition stop during blanking

After the camera transferred a whole frame, the camera goes into wait state. When user sends an **AcquisitionStop** command in wait state, the camera will return to stop acquisition state. The camera will not send any frames even if it is just going to start the next exposing.

### 8.2.2. Acquisition Mode

Two camera acquisition modes are available: single frame acquisition mode and continuous acquisition mode.

- Single frame acquisition mode: In single frame acquisition mode, the camera will only acquire one frame of image at a time

1) When the trigger mode is set to On, the trigger type is arbitrary

After executing the **AcquisitionStart** command, the camera waits for a trigger signal, which may be a software trigger or a hardware trigger of the camera. When the camera receives the trigger signal and acquires an image, the camera will automatically stop image acquisition. If you want to acquire another frame of image, you must execute the **AcquisitionStart** command again.

2) When the trigger mode is set to Off

After executing the **AcquisitionStart** command, the camera acquires one frame of image and then automatically stops image acquisition. If you want to acquire another frame of image, you must execute the **AcquisitionStart** command again.



In single frame acquisition mode, you must execute the **AcquisitionStop** command to set the functions that cannot be set in the acquisition status, such as ROI, packet size, etc.

- Continuous acquisition mode: In continuous acquisition mode, the camera continuously acquires and transmits images until the acquisition is stopped

1) When the trigger mode is set to On, the trigger type is **FrameStart**

After executing the **AcquisitionStart** command, the camera waits for a trigger signal, which may be a software trigger or a hardware trigger of the camera. Each time the camera receives a trigger signal, it can



acquire a frame of image until the **AcquisitionStop** command is executed. It is not necessary to execute the **AcquisitionStart** command every time.

2) When the trigger mode is set to On, the trigger type is **FrameBurstStart**

After executing the **AcquisitionStart** command, the camera waits for a trigger signal, which may be a software trigger or a hardware trigger of the camera. Each time the camera receives a trigger signal, it can continuously acquire the set **AcquisitionFrameCount** frames of image. If the **AcquisitionStop** command is received during the acquisition process, the image being transmitted may be interrupted, resulting in the number of images acquired this time not reaching the **AcquisitionFrameCount** frames of image.

3) When the trigger mode is set to Off

After executing the **AcquisitionStart** command, the camera will continuously acquire images until it receives the **AcquisitionStop** command.

 You can check if the camera is in the waiting trigger status by the camera's trigger wait signal or by using the acquisition status function.

### 8.2.3. Trigger Type Selection

Two camera trigger types are available: **FrameStart** and **FrameBurstStart**. Different trigger types correspond to their respective set of trigger configurations, including trigger mode, trigger delay, trigger source, trigger polarity, and software trigger commands.

- **FrameStart** trigger mode

The **FrameStart** trigger is used to acquire one image. Each time the camera receives a **FrameStart** trigger signal, the camera begins to acquire an image.

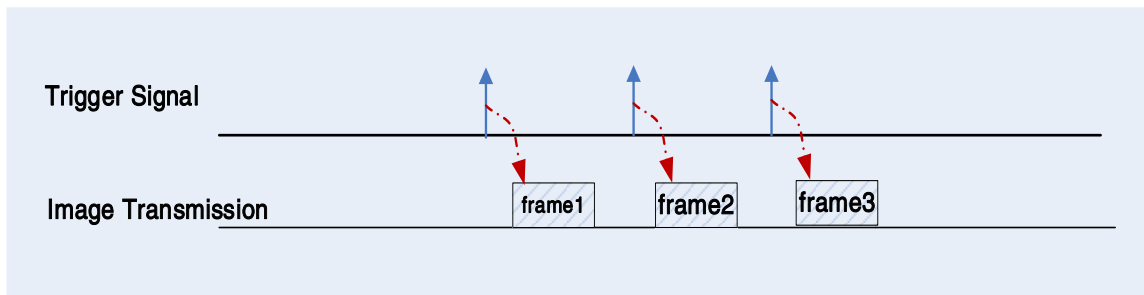

Figure 8-17 FrameStart trigger

- **FrameBurstStart** trigger mode

You can use the **FrameBurstStart** trigger signal to acquire a series of images ("continuous shooting" of the image). Each time the camera receives a **FrameBurstStart** trigger signal, the camera will start acquiring a series of images. The number of acquired image frames is specified by the "Acquisition burst frame count" parameter. The range of "Acquisition burst frame count" is 1~65535, and the default value is 1.

For example, if the "Acquisition burst frame count" parameter is set to 3, the camera automatically acquires 3 images. Then, the camera waits for the next **FrameBurstStart** trigger signal. After receiving the next trigger signal, the camera will take another 3 images, and so on.

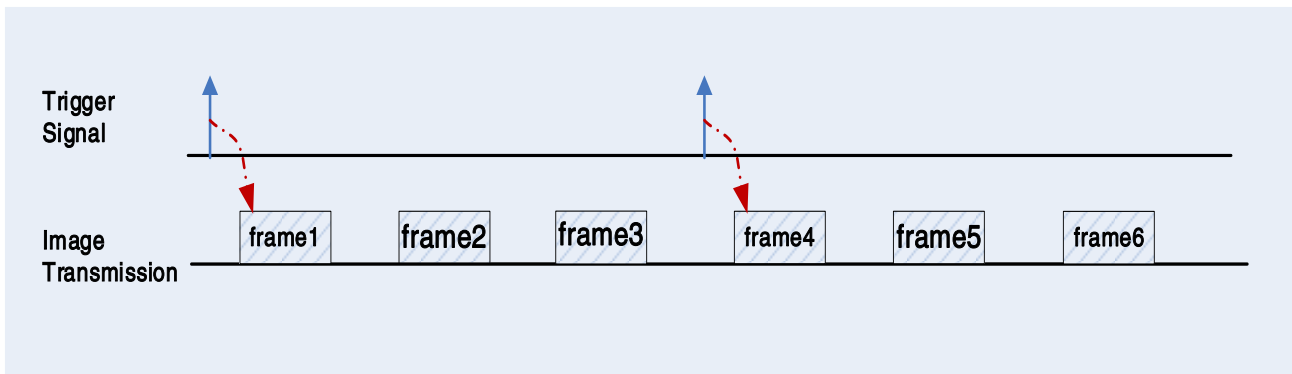

Figure 8-18 FrameBurstStart trigger

- FrameStart trigger mode and FrameBurstStart trigger mode are selected at the same time

If the **FrameStart** trigger mode and the **FrameBurstStart** trigger mode are selected at the same time, the trigger sequence is: first send the **FrameBurstStart** trigger signal, then send the **FrameStart** trigger signal. Each time a **FrameStart** trigger signal is sent, an image is acquired until the value of the "Acquisition burst frame count" parameter is reached.

For example, the **FrameStart** trigger mode and the **FrameBurstStart** trigger mode are selected at the same time. If the "Acquisition burst frame count" parameter is set to 3, when the camera receives a **FrameBurstStart** trigger signal, no image will be acquired. When the **FrameStart** trigger signal is received, the camera will acquire 1 image, each time a **FrameStart** trigger signal is received, the camera will acquire 1 image. When 3 images are acquired, the camera will wait for the next **FrameBurstStart** trigger signal, and so on.

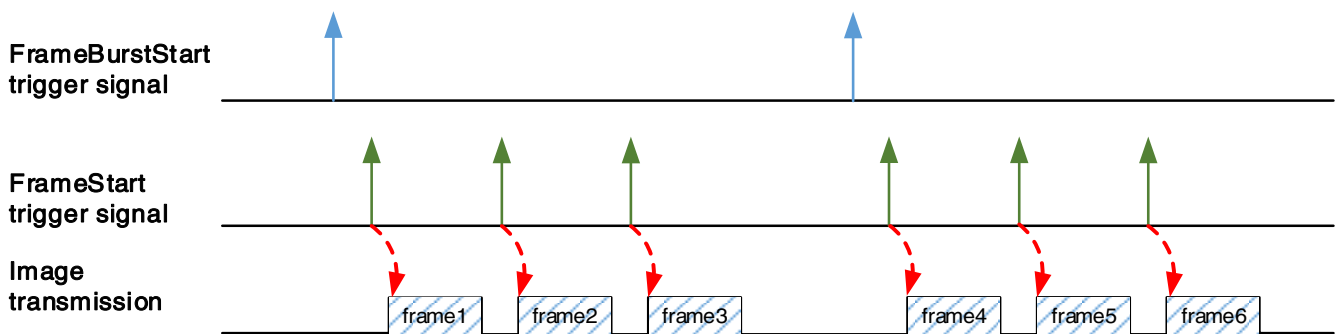

Figure 8-19 Two trigger modes are selected at the same time

### 8.2.4. Switching Trigger Mode

During the stream acquisition process, the user can switch the trigger mode of the camera without the **AcquisitionStop** command.

As shown below, switching the trigger mode at different positions will have different results.

- Switch trigger mode during frame reading out

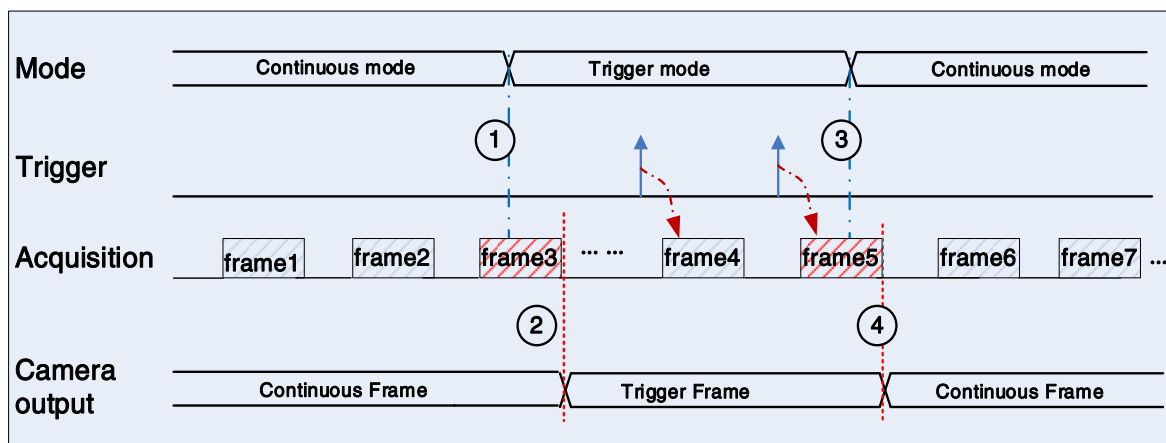

Figure 8-20 Switch trigger mode during frame reading out

As shown in Figure 8-20, the camera starts with trigger mode **OFF** after receiving acquisition start command.

At point 1, the camera gets a command of setting trigger mode **ON** while transferring the 3<sup>rd</sup> frame in trigger mode **OFF**. The trigger mode is not active until the 3<sup>rd</sup> frame is finished, at point 2, and then the trigger signal will be accepted. At point 3, the camera gets a command of switching back to **OFF**. It is also not active until the 5<sup>th</sup> frame is finished, it should wait a complete reading out. The camera switches from trigger mode to continuous mode at point 4, and then the camera works in continuous mode.

- Switch trigger mode during blanking

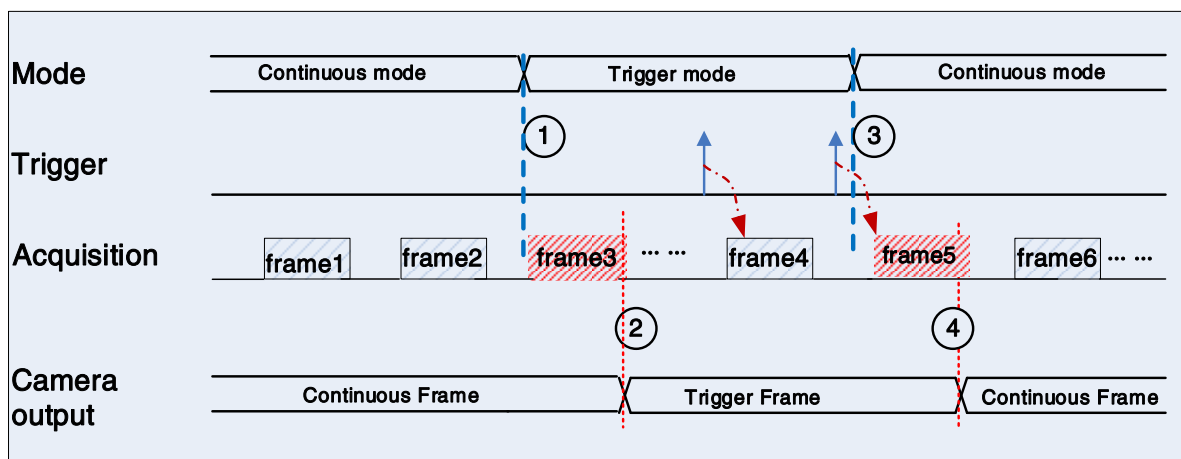

Figure 8-21 Switch trigger mode during blanking

As shown in Figure 8-21, the camera with trigger mode **OFF** begins after receiving an **AcquisitionStart** command.

At point 1, the camera gets a command of setting trigger mode **ON** while it is in wait state. The trigger mode is not active until the 3<sup>rd</sup> frame is finished, i.e., point 2. Please note that the 3<sup>rd</sup> frame does not belong to trigger mode. All trigger frames need trigger signals or software trigger commands. At point 3, the camera gets a command of switching back to continuous mode. It is also not active until the 5<sup>th</sup> frame is finished, it should wait a complete frame. The camera switches from trigger mode to continuous mode at point 4, and then the camera works in continuous mode.

### 8.2.5. Continuous Mode and Configuration

- **Continuous mode configuration**

The default value of **Trigger Mode** is **OFF** in default user set. If the camera is opened with default user set, the camera works in continuous mode directly. Otherwise, user can set **Trigger Mode** to **OFF** to work in continuous mode.

Other parameters also can be changed in **Trigger Mode OFF**.

- **Continuous mode features**

In continuous acquisition mode, the camera acquires and transmits images according to camera parameter set.



In continuous mode, ROI size may have effects on frame rate.

### 8.2.6. Acquisition Burst Mode

Acquisition burst mode setting is only applicable to trigger mode, and support three combinations:

- 1) Acquisition mode: Continuous, Trigger type: FrameStart ON / FrameBurstStart ON
- 2) Acquisition mode: Continuous, Trigger type: FrameStart ON / FrameBurstStart OFF
- 3) Acquisition mode: Continuous, Trigger type: FrameStart OFF / FrameBurstStart ON

Trigger types support software trigger and hardware trigger.

When FrameStart OFF / FrameBurstStart OFF, the maximum frame rate output by the camera is limited by the physical bandwidth of the USB 3.0 interface, so camera is under standard mode. In this mode, the frame rate is lower or equal to the current transmission capacity (influenced by the current exposure time, image size and other factors).

When the combination of trigger modes is any of the above three, the maximum frame rate output by the camera is not limited by the physical bandwidth of the USB 3.0 interface, and acquisition is conducted according to the maximum acquisition capacity of the sensor, and the frame rate is generally greater than the current transmission capacity (depends on sensor rate). Because of the acquisition bandwidth is greater than the transmission bandwidth, frame dropping may occur due to insufficient buffer.



When the acquisition burst mode enabled, due to the bandwidth difference of the sensor and the performance difference of the host computer, frame dropping may occur during long operation. To avoid this situation, the frame rate control switch should be enabled to limit the acquisition frame rate. The following table lists the cameras that support acquisition burst mode and the frames in various acquisition modes.

- **Related Parameters**

**Continuous mode maximum frame rate:** The maximum frame rate of camera when trigger mode and device bandwidth limit is OFF. Default full frame and short exposure time, and camera is limited by interface bandwidth at this time.

**Trigger mode maximum frame rate:** The maximum frame rate of camera when FrameStart or FrameBurstStart is ON. Default full frame and short exposure time, and camera is not limited by interface

bandwidth at this time.

**Acquisition burst mode permissible frames:** To ensure that frame dropping could not occur, the maximum number of trigger signals (FrameStart ON / FrameBurstStart OFF and frame rate is equal to trigger mode maximum frame rate) or the maximum high-speed burst frames (FrameStart OFF / FrameBurstStart ON and camera is under FrameBurstStart trigger mode) of camera.



When the user sends the trigger signal to the camera at a frequency lower than the maximum frame rate of trigger mode, the permissible frame number for acquisition burst will be increased.

Camera models that support this feature and relevant parameters:

Model	Pixel formats (sensor bit depth)	Continuous mode maximum frame rate (fps)	Trigger mode maximum frame rate (fps)	Acquisition burst mode permissible frames
MARS-3250-12U3M/C	8	12.16	17.52	52
	12	6.08	8.76	26
MARS-4470-8U3M/C	8	8.83	15.86	17
	12	4.42	7.93	7

### 8.2.7. Software Trigger Acquisition and Configuration

- **Software trigger acquisition configuration**

The camera supports software trigger acquisition mode. Three steps followed should be ensured.

- 1) Set the Trigger Mode to ON.
- 2) Set the Trigger Source to Software.
- 3) Send Software Trigger command.

All the software trigger commands are sent by the host through the USB3.0 bus, to trigger the camera to acquire and transmit images.

- **Software trigger acquisition features**

In software trigger acquisition mode, the camera begins to acquire one image after receiving software trigger commands. In general, the number of frames is equal to the number of software trigger commands. The relative features are illustrated below:

- 1) In software trigger acquisition mode, if the trigger frequency is lower than permissible maximal FPS (Frame per Second) of the camera, the current frame rate is trigger frequency. If the trigger frequency is higher than permissible maximal FPS (Frame per Second) of the camera, some software triggers are ignored and the current frame rate is lower than trigger frequency.
- 2) The trigger delay feature can control the camera delay interval between your triggers and the camera acquiring frames. The default value of trigger delay time is zero.

### 8.2.8. Hardware Trigger Acquisition and Configuration

- **Hardware trigger acquisition configuration**

The camera supports hardware trigger acquisition mode. Three steps followed should be ensured:

- 1) Set the Trigger Mode to ON.
- 2) Set the Trigger Source to Line0, Line2 or Line3.
- 3) Connect hardware trigger signal to Line0.

If the Trigger Source is set by Line2 or Line3, it should be ensured that the corresponding Line is set as Input.

Please refer to section 8.1.1 for more information of the programmable GPIOs.

- **Hardware Trigger acquisition features**

The relative features about the camera's trigger signal process are illustrated below:

- 1) The polarity of lines can be set to inverted or not inverted, and the default setting is not inverted.
- 2) Improper signal can be filtered by setting appropriate value to trigger filter. Raising edge filter and falling edge can be set separately. The range is from 0 to 5000 us. The default configuration is not use trigger filter.
- 3) The time interval between trigger and exposure can be set through the trigger delay feature. The range of time interval covers from 0 to 3000000 $\mu$ s. The default value of trigger delay time is zero.

The features, like trigger polarity, trigger delay and trigger filter, can be select in the GalaxyView.



The camera's trigger source Line0 uses opto-isolated circuit to isolate signal. Its internal circuit delay trigger signal and rising edge's delay time is less than falling edge's. There are a dozen clock cycles delay of rising edge and dozens clock cycles delay of falling edge. If you use Line0 to trigger the camera, the positive pulse signal's positive width will be wider (about 20-40 $\mu$ s) and the negative pulse signal's negative width will be narrower (about 20-40 $\mu$ s). You can adjust filter parameter to accurately filter trigger signal.

### 8.2.9. Overlapping Exposure and Non-overlapping Exposure

There are two stages in image acquisition of the MARS-U3 series camera: exposure and readout. Once the camera is triggered, it begins to integrate and when the integration is over, the image data will be read out immediately.

The MARS-U3 series camera supports two exposure modes: Overlapping exposure and non-overlapping exposure. The user cannot assign the overlapping exposure or non-overlapping exposure directly, it depends on the frequency of trigger signal and the exposure time. The two exposure mode are described as below.

- **Non-overlapping exposure**

In non-overlapping exposure mode, after the exposure and readout of the current frame are completed, then the next frame will expose and read out. As shown in the Figure 8-22, the N<sup>th</sup> frame is read out, after a period of time, the N+1<sup>th</sup> frame to be exposed.

The formula of non-overlapping exposure frame period:

non-overlapping exposure frame period > exposure time + readout time

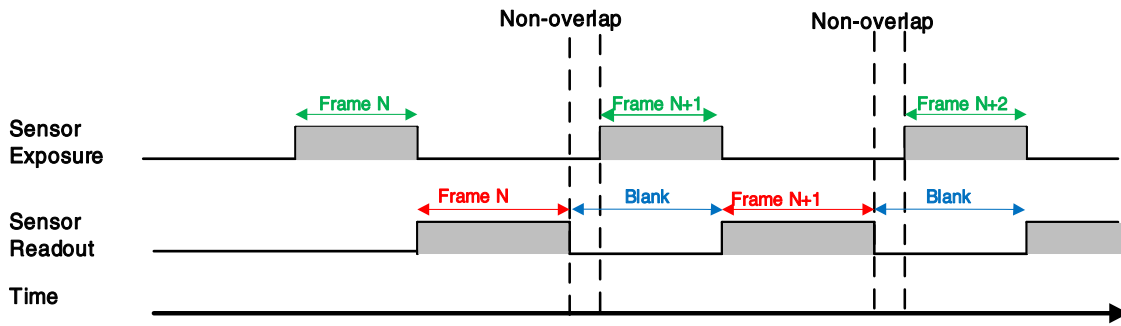

Figure 8-22 The exposure sequence diagram in non-overlapping exposure mode

● Trigger acquisition mode

If the interval between two triggers is greater than the sum of the exposure time and readout time, overlapping exposure will not occur, as shown in Figure 8-23.

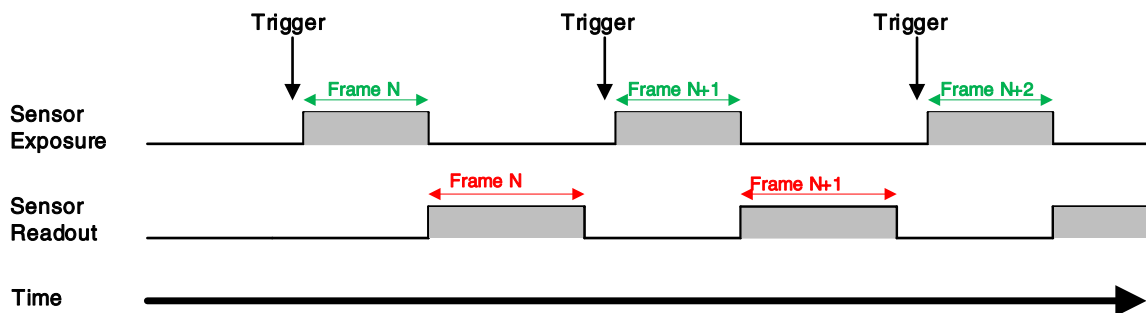

Figure 8-23 The trigger acquisition exposure sequence diagram in non-overlapping exposure mode

● Overlapping exposure

In overlapping exposure mode, the current frame image exposure process is overlap with the readout of the previous frame. That is, when the previous frame is reading out, the next frame image has been started exposure. As shown in the Figure 8-24, when the N<sup>th</sup> frame image is reading out, the N+1<sup>th</sup> frame image has been started exposure.

The formula of overlapping exposure frame period:

overlapping exposure frame period ≤ exposure time + readout time

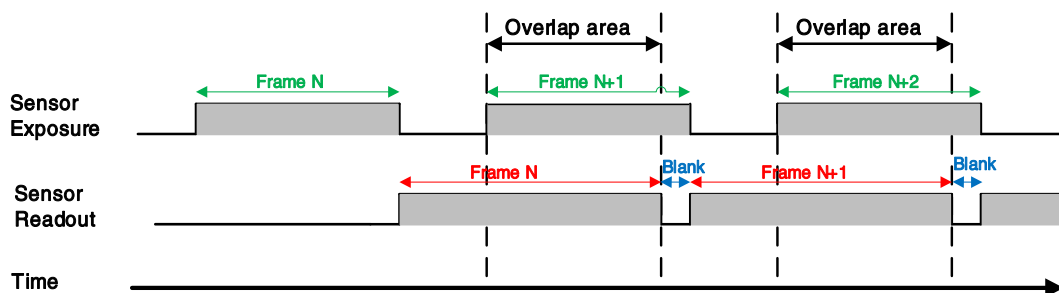

Figure 8-24 The exposure sequence diagram in overlapping exposure mode

- **Continuous acquisition mode**

If the exposure time is greater than the frame blanking time, the exposure time and the readout time will be overlapped. As shown in the Figure 8-24.

- **Trigger acquisition mode**

When the interval between two triggers is less than the sum of exposure time and the readout time, overlapping exposure will occur, as shown in Figure 8-25.

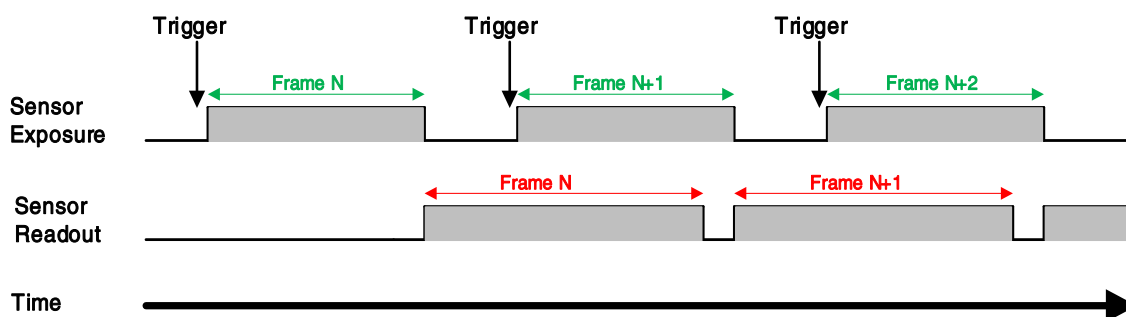

Figure 8-25 The trigger acquisition exposure sequence diagram in overlapping exposure mode

Compared with non-overlapping exposure mode, in overlapping exposure mode, the camera can obtain higher frame rate.

## 8.2.10. Set Exposure

### 8.2.10.1. Set Exposure Mode

Two Exposure Mode are available: Timed exposure mode and TriggerWidth exposure mode. Among them, the TriggerWidth exposure mode determines the exposure time when the camera is configured for hardware triggering. And the exposure time depends on the width of the trigger signal, which is triggered by the rising edge (falling edge) set by the Trigger Activation.

#### 1) Available exposure mode

##### a) Timed exposure mode

Timed exposure mode is available on all camera models. In this mode, the exposure time is determined by the camera's Exposure Time setting. If the camera is configured for software triggering, exposure starts when the software trigger signal is received and continues until the exposure time has expired.

If the camera is configured for hardware trigger:

- If rising edge triggering is enabled, exposure starts when the trigger signal rises and continues until the exposure time has expired, as shown in Figure 8-26



Figure 8-26 The sequence diagram in rising edge trigger of Timed exposure mode



- If falling edge triggering is enabled, exposure starts when the trigger signal falls and continue until the exposure time has expired, as shown in Figure 8-27

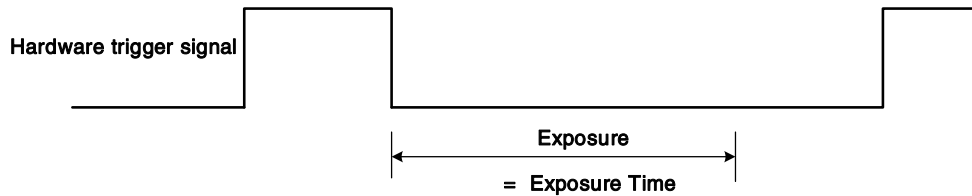

Figure 8-27 The sequence diagram in falling edge trigger of Timed exposure mode

Avoid overtriggering in Timed exposure mode. If the Timed exposure mode is enabled, do not attempt to send a new trigger signal while the previous exposure is still in progress. Otherwise, the trigger signal will be ignored, and a FrameStartOvertrigger event will be generated.

b) TriggerWidth exposure mode

In TriggerWidth exposure mode, the length of exposure is determined by the width of the hardware trigger signal. This function can meet the needs of users to change the exposure time of each frame of image.

- If rising edge triggering is enabled, exposure starts when the trigger signal rises and continue until the trigger signal falls, as shown in Figure 8-28

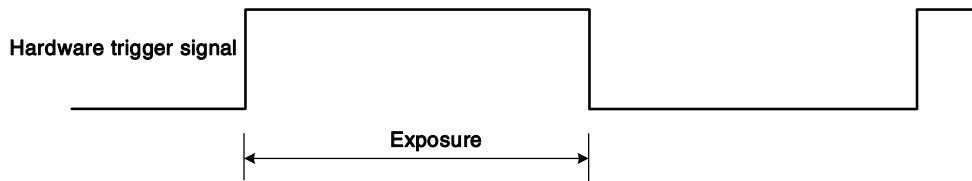

Figure 8-28 The sequence diagram in rising edge trigger of TriggerWidth exposure mode

- If falling edge triggering is enabled, exposure starts when the trigger signal falls and continue until the trigger signal rises, as shown in Figure 8-29

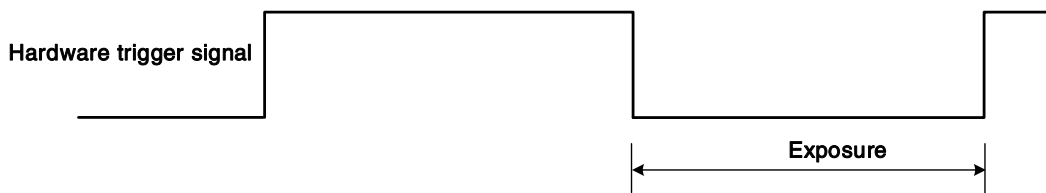

Figure 8-29 The sequence diagram in falling edge trigger of TriggerWidth exposure mode

Avoid overtriggering in TriggerWidth exposure mode. If the TriggerWidth exposure mode is enabled, do not send trigger signals at too high a rate. Otherwise, trigger signals will be ignored, and a FrameStartOvertrigger event will be generated.

2) Prerequisites

- Set the TriggerMode parameter to On.
- Set the TriggerSource parameter to one of the available hardware trigger sources, e.g., Line0.
- Set the ExposureMode parameter to TriggerWidth (if available).

### 3) How it works

The user can use overlapping image acquisition to increase the frame rate of the camera. With overlapping image acquisition, the exposure of a new image begins while the camera is still reading out the sensor data of the previous image.

In TriggerWidth exposure mode, the camera does not "know" how long the image will be exposed before the trigger period is complete. Therefore, the camera cannot fully optimize overlapping image acquisition. To avoid this problem, the user can enter a value for the ExposureOverlapTimeMax parameter, which represents the shortest exposure time the user intends to use (in  $\mu\text{s}$ ). This helps the camera optimize the overlapping image acquisition.

### 4) Set ExposureOverlapTimeMax

To optimize the frame rate of the camera, the exposure mode should be set to TriggerWidth:

- a) Set the ExposureMode parameter to TriggerWidth.
- b) Enter a value for the ExposureOverlapTimeMax parameter, which represents the shortest exposure time the user intends to use (in  $\mu\text{s}$ ).

Example: Assume that the user wants to trigger the camera to apply exposure times in the range of 3000  $\mu\text{s}$  to 5500  $\mu\text{s}$ , the user needs to set the ExposureOverlapTimeMax parameter of the camera to 3000.

- 1) The trigger signal width of the hardware triggering should not be shorter than the value of the entered ExposureOverlapTimeMax parameter.



- 2) The maximum settable value of the ExposureOverlapTimeMax parameter is related to camera connection configuration, image ROI height, etc. When the maximum settable value of the parameter is reduced due to modifying the above configuration, it may affect the current value of the input ExposureOverlapTimeMax parameter.

#### 8.2.10.2. Set Sensor Exposure Mode

##### ● Global Shutter

The implementation process of global shutter is as shown in Figure 8-30, all the lines of the sensor are exposed at the same time, and then the sensor will read out the image data one by one.

The advantage of the global shutter is that all the lines are exposed at the same time, and the images do not appear offset and distortion when capturing moving objects.

The time width of the flash signal can be got by the following formula:

$$T_{\text{strobe}} = T_{\text{exposure}}$$

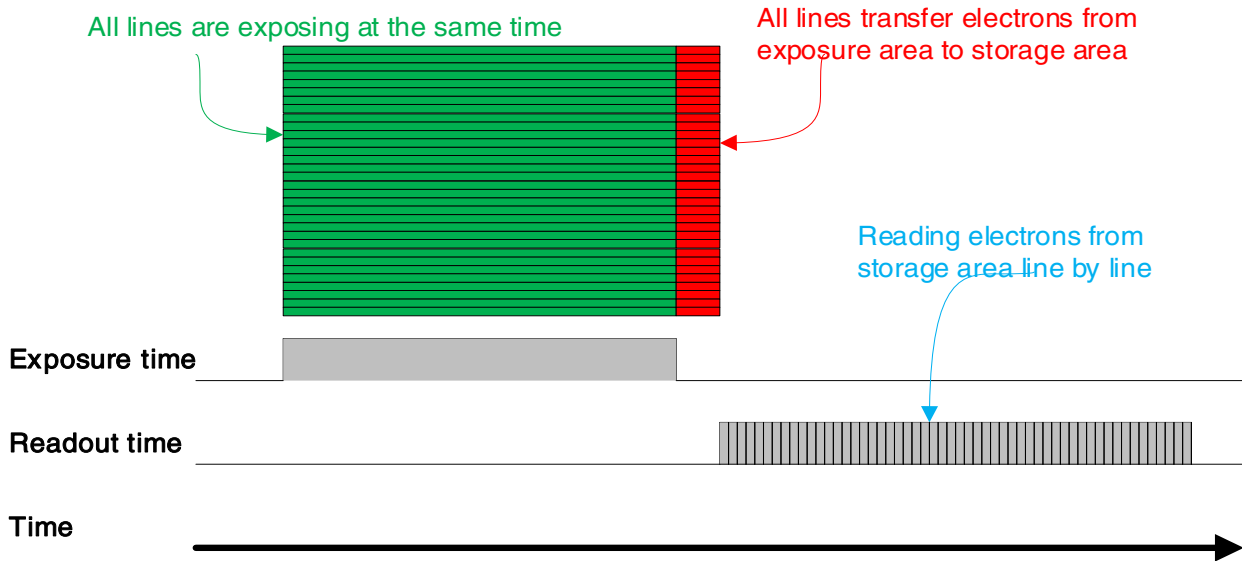

Figure 8-30 Global shutter

● **Electronic Rolling Shutter**

The implementation process of electronic rolling shutter is as shown in Figure 8-31, different from the global shutter, electronic rolling shutter exposes from the first line, and starts the second line exposure after a row period. And so on, after N-1 line, the N line starts exposing. When the first line exposure ends, it begins to read out the data, and it need a row period time to read out one line (including the line blanking time). When the first line reads out completely, the second line just begins to read out, and so on, when the N-1 line is read out, the N line begins to read out, until the whole image is read out completely.

The electronic rolling shutter has low price and high resolution, which is a good choice for some static image acquisition.

The time width of the flash signal can be got by the following formula:

$$T_{\text{strobe}} = T_{\text{exposure}} - (N-1) \times T_{\text{row}}$$

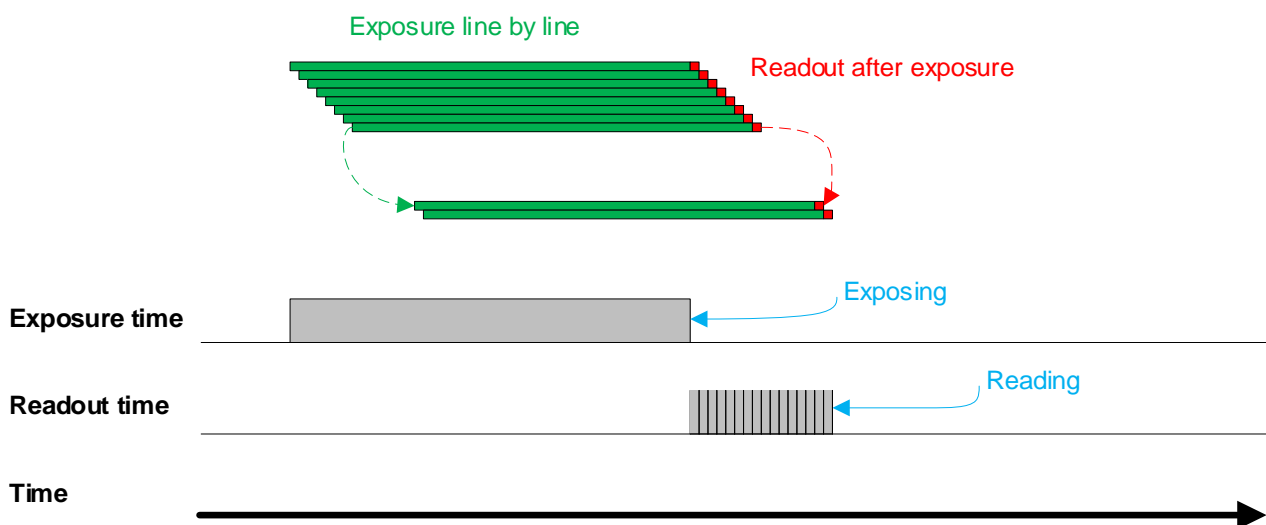

Figure 8-31 Electronic rolling shutter

● Global Reset Release Shutter

As the sensor starts exposure line by line, all of the pixels in the sensor start exposing at the same time. However, the end time of upper lines and lower lines of the same frame of image is different when capturing fast moving objects, so the distortion will occur. The Global Reset Release (GRR) shutter mode can effectively avoid the distortion. If the camera is operated in the GRR shutter mode, you must use flash lighting.

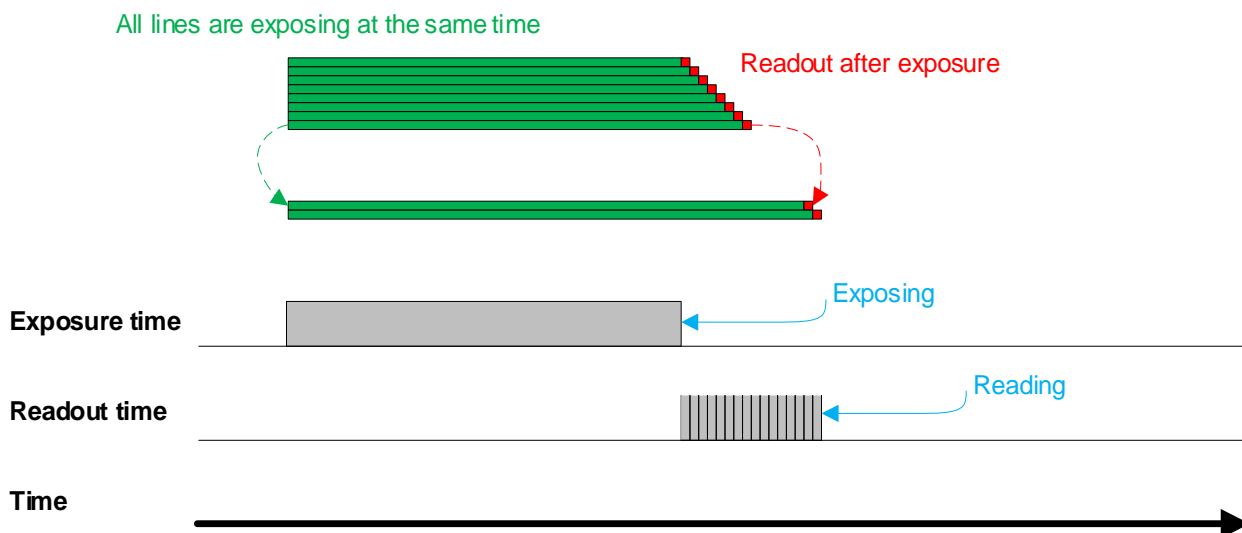

Figure 8-32 Global Reset Release shutter

Line-by-line exposure sensor starts exposure at the same time in GRR mode, and the exposure ends successively from top to bottom. As shown in the Figure 8-32, the exposure time is the common exposure interval, which is also the interval that the flash lighting needs to be opened. That is, the exposure time signal goes high when you can start the flash lighting, and the exposure time signal goes low when you should stop the flash lighting. Otherwise, the brightness in the acquired images will vary significantly from top to bottom due to the differences in the exposure time of the individual lines. In addition, the image will be distortional due to different exposure end time of the individual lines.

The exposure delay is supported in GRR mode. At the same time, there is a certain delay due to the flash lighting, and the actual duration of the flash is as follows:

$$T_{\text{strobe}} = T_{\text{exposure}} + T_{\text{exp\_delay}} + T_{\text{row}} \times 18$$

Settings:

- 1) Set the SensorShutterMode to Global Reset.
- 2) Connect the camera to the flash lighting.

8.2.10.3. Set Exposure Time

According to the length of the exposure time, two exposure time modes of the MARS USB3 Vision camera are available: Standard exposure time mode and UltraShort exposure time mode.

In Standard exposure time mode, three exposure time adjustment modes are available: manual adjustment, one-time automatic adjustment and continuous automatic adjustment. The standard exposure

time mode is the default setting. For the manual adjustment, please refer to section 8.2.11. For the automatic adjustment and continuous automatic adjustment, please refer to section 8.3.4.

In UltraShort exposure time mode, the MARS USB3 Vision camera only supports manual adjustment of the exposure time. Since standard exposure time mode is the default setting, if you want to set the UltraShort exposure time mode, you first need to adjust the visibility level to guru and set the ExposureTimeMode to UltraShort under the acquisition control features window.



In UltraShort exposure time mode, the MARS USB3 Vision camera does not support automatic adjustment of the exposure time, only support manual adjustment of the exposure time.

#### 8.2.10.4. Set Value of Exposure Time

The MARS USB3 Vision camera supports setting the exposure time, step: 1 $\mu$ s.

The exposure precision of the camera is limited by the sensor, when the steps in the user's interface and the demo display as 1 $\mu$ s, actually the steps are one row period. When the value of the ExposureTime cannot be divisible by the row period, round up to an integer should be taken, such as the row period is 36 $\mu$ s, setting exposure time to 80 $\mu$ s, and the actual exposure time is 108 $\mu$ s.

When the external light source is sunlight or direct current (DC), the camera has no special requirements for the exposure time. When the external light source is alternating current (AC), it is recommended that the exposure time is better to be integral multiple of the light source cycle, for example, for a 100Hz light source, it is better to set the exposure time as an integral multiple of 10ms (the frequency of fluorescent lamp we usually use is 50Hz).

The MARS USB3 Vision camera supports Auto Exposure feature. If the Auto Exposure feature is enabled, the camera can adjust the exposure time automatically according to the environment brightness. See section 8.3.4.3 for more details.

#### 8.2.11. Exposure Delay

The exposure delay function can effectively solve the strobe delay problem. Most strobes have a delay of at least tens of microseconds from trigger to light. When the camera is working in a small exposure mode, the fill light effect of the strobe will be affected. The exposure delay is achieved by the strobe signal and the delay of the actual exposure starting.

The unit of exposure delay is  $\mu$ s, the range is 0 ~ 5000 $\mu$ s, and the minimum value is 0.

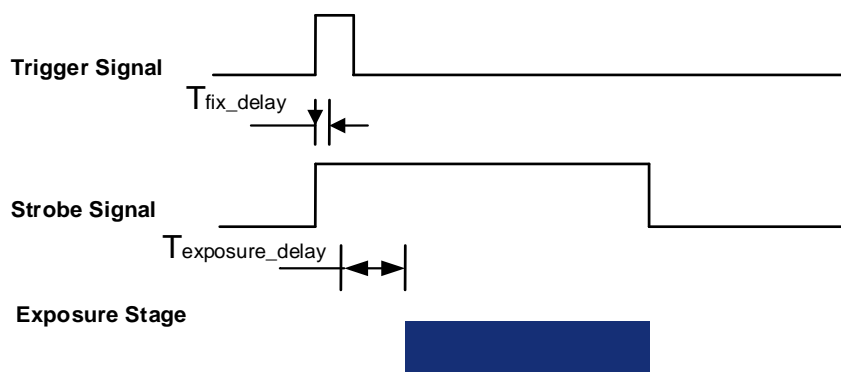

Figure 8-33 The exposure delay sequence diagram in overlapping exposure mode

When a hardware trigger signal is received to the sensor to start exposure, there is a small delay, which is called the exposure delay and consists of four parts of time, as shown in Figure 8-34.

T1: The delay introduced by the hardware circuit when the external signal passes through the optocoupler or GPIO. The value is generally in the range of several to several tens of  $\mu\text{s}$ . The delay is mainly affected by the connection mode, driving intensity and temperature. When the external environment is constant, the delay is generally stable.

T2: Delay introduced by the trigger filter. For example, if the trigger filter time is set to  $50\mu\text{s}$ , T2 is  $50\mu\text{s}$ .

T3: Trigger delay (trigger\_delay), the camera supports trigger delay feature. If the trigger delay is set to  $200\mu\text{s}$ , T3 is  $200\mu\text{s}$ .

T4: The sensor timing sequence delay, the internal exposure of the sensor is aligned with the row timing sequence, so T4 has a maximum row cycle jitter. The value of each sensor is different. Some products with large delay time (several hundred  $\mu\text{s}$  or more) have additional configuration time counted in T4.

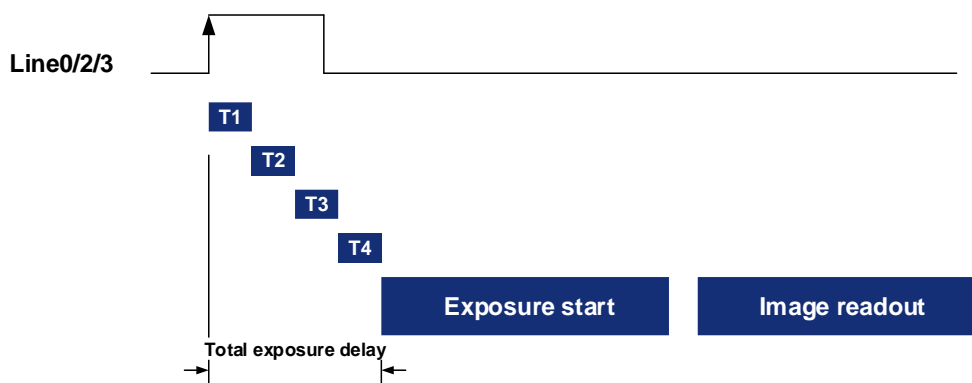

Figure 8-34 Exposure delay

The following table shows the total exposure delay time for each sensor.

T1 is calculated according to the typical delay ( $5\mu\text{s}$ ) of line0. If it is line2/3, T1 can be ignored.

T2 is calculated as  $0\mu\text{s}$ .

T3 is calculated as  $0\mu\text{s}$ .

T4 is calculated according to the ROI settings and features of each sensor.

The exposure delay data for each model is as follows:

Model	Exposure delay ( $\mu\text{s}$ )
MARS-3250-12U3M/C	BayerRG8/Mono8: 51.6 BayerRG12/Mono12: 97.6
MARS-4470-8U3M/C	BayerRG8/Mono8: 51.6 BayerRG12/Mono12: 97.6

Table 8-2 MARS-U3 series camera exposure delay range

### 8.3. Basic Features

#### 8.3.1. Gain

The MARS-U3 series camera can adjust the analog gain, the adjustable range of every model refer to 4. General Specification.

When the analog gain changes, the response curve of the camera changes, as shown in Figure 8-35. The horizontal axis represents the output signal of the sensor in the camera, and the vertical axis represents the gray value of the output image. When the amplitude of the sensor output signal remains constant, increasing the gain makes the response curve steeper, and that makes the image brighter. For every 6dB increases of the gain, the gray value of the image will double. For example, when the camera has a gain of 0dB, the image gray value is 126, and if the gain is increased to 6dB, the image gray will increase to 252. Thus, increasing gain can be used to increase image brightness. When the environment brightness and exposure time keep constant, another way to increase the image brightness is to change the camera's digital gain by modifying the lookup table.

Note that increasing the analog gain or digital gain will amplify the image noise.

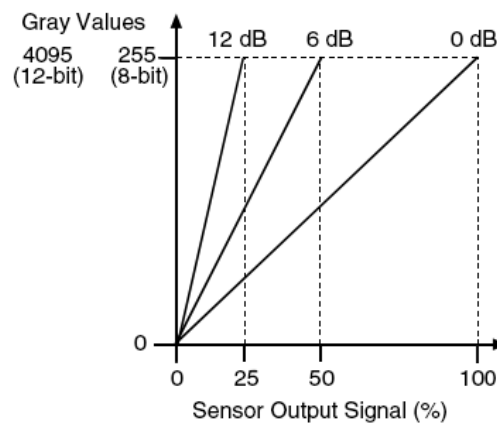

Figure 8-35 The cameras response curve

#### 8.3.2. Pixel Format

By setting the pixel format, the user can select the format of output image. The available pixel formats depend on the camera model and whether the camera is monochrome or color.

The image data starts from the upper left corner, and each pixel is output brightness value of each pixel line from left to right and from top to bottom.

● Mono8

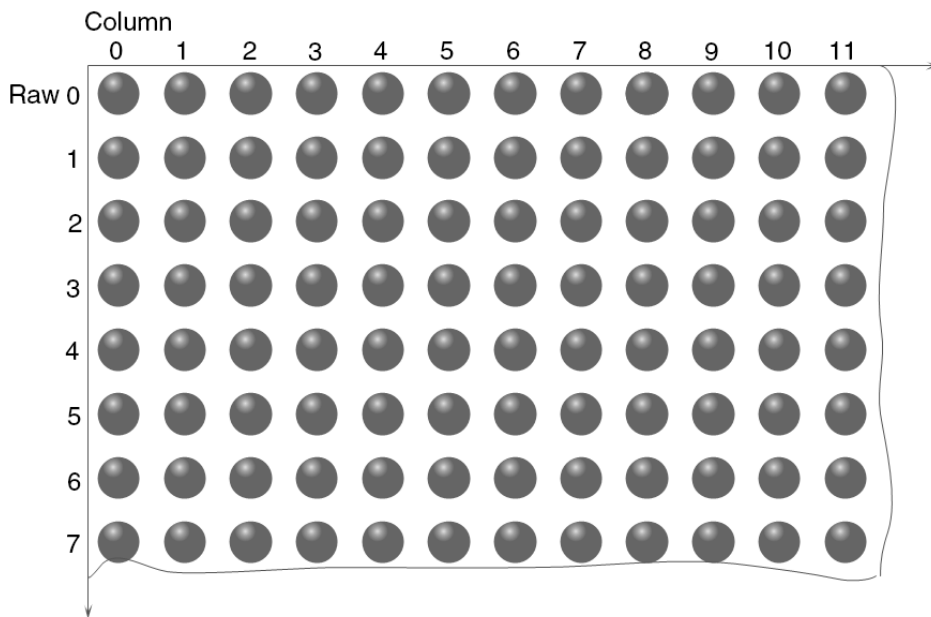

When the pixel format is set to Mono8, the brightness value of each pixel is 8 bits. The format in the memory is as follows:

Y00	Y01	Y02	Y03	Y04	.....
Y10	Y11	Y12	Y13	Y14	.....
.....					

Among them Y00, Y01, Y02 ... are the gray value of each pixel that starts from the first row of the image. Then the gray value of the second row pixels of the images is Y10, Y11, and Y12...

● Mono10/Mono12

When the pixel format is set to mono10 or Mono12, each pixel is 16 bits. When Mono10 is selected, the effective data is only 10 bits, the six unused most significant bits are filled with zero. When Mono12 is selected, the effective data is only 12 bits, the 4 of the MSB 16 bits data are set to zero. Note that the brightness value of each pixel contains two bytes, arranged in little-endian mode. The format is as follows:

Y00	Y01	Y02	Y03	Y04	.....
Y10	Y11	Y12	Y13	Y14	.....
.....					

Among them Y00, Y01, Y02...are the gray value of each pixel that start with the first row of the image. The first byte of each pixel is low 8 bits of brightness, and the second byte of each pixel is high 8 bits of brightness.



● BayerRG8

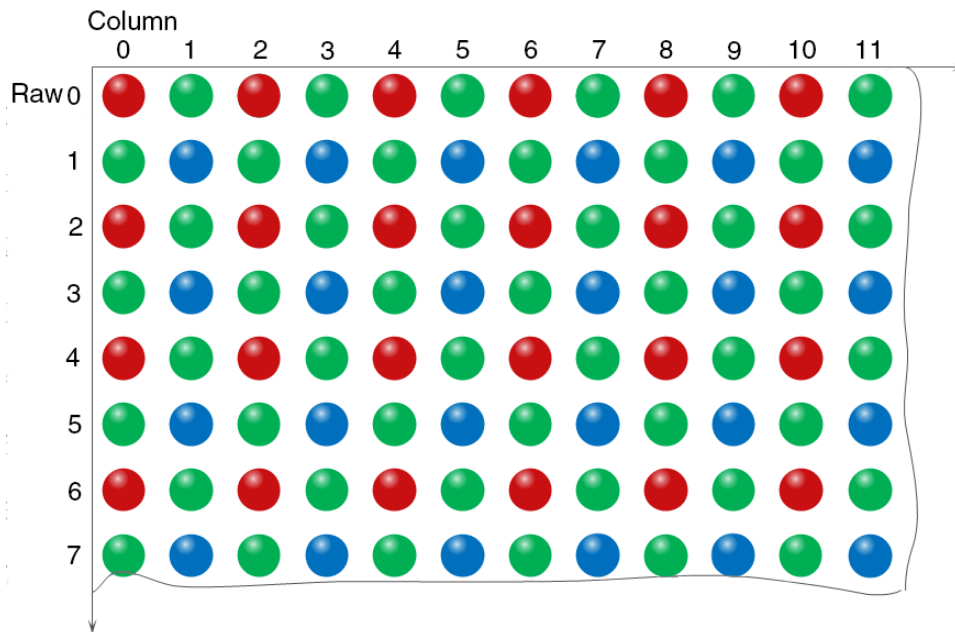

When the pixel format is set to BayerRG8, the value of each pixel in the output image of the camera is 8 bits. According to the location difference, the three components of red, green and blue are respectively represented. The format in the memory is as follows:

R00	G01	R02	G03	R04	.....
G10	B11	G12	B13	G14	.....
.....					

Where R00 is the first pixel value of the first row (for the red component), G01 represents the second pixel value (for the green component), and so on, so that the first row pixel values are arranged. G10 is the first pixel value of the second row (for the green component), the B11 is the second pixel value (for the blue component), and so on, and the second row of pixel values are arranged.

● BayerRG10/BayerRG12

When the pixel format is set to BayerRG10 or BayerRG12, the value of each pixel in the output image of the camera is 16 bits. According to the location difference, the three components of red, green and blue are respectively represented. The format in the memory is as follows:

R00	G01	R02	G03	R04	.....
G10	B11	G12	B13	G14	.....
.....					

Each pixel is the same as BayerRG8, the difference is that each pixel is made up of two bytes, the first byte is the low 8 bits of the pixel value, and the second byte is the high 8 bits of the pixel value.

● BayerGR8

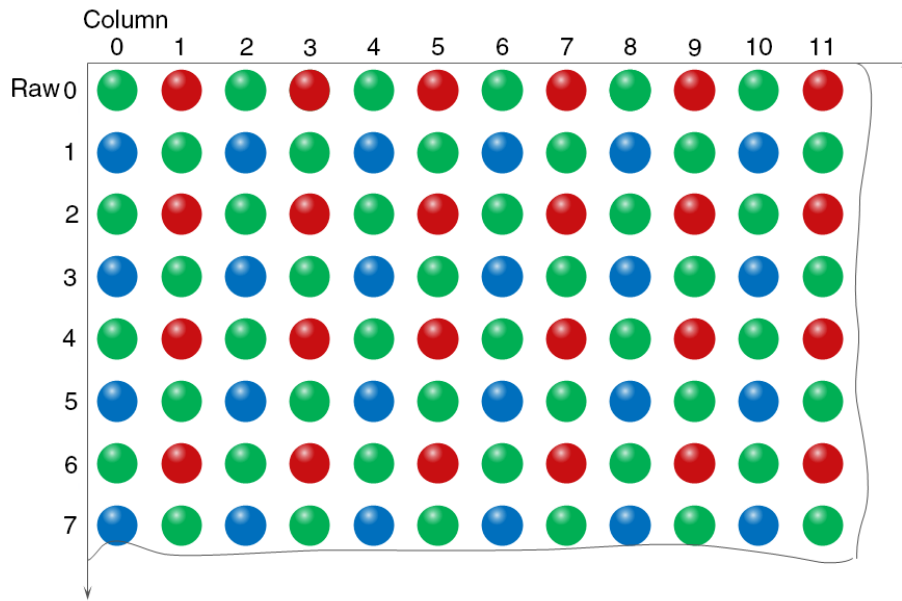

When the pixel format is set to BayerGR8, the value of each pixel in the output image of the camera is 8 bits. According to the location difference, the three components of red, green and blue are respectively represented. The format in the memory is as follows:

G00	R01	G02	R03	G04	.....
B10	G11	B12	G13	B14	.....
.....					

Where G00 is the first pixel value of the first row (for the green component), R01 represents the second pixel value (for the red component), and so on, so that the first row pixel values are arranged. B10 is the first pixel value of the second row (for the blue component), the G11 is the second pixel value (for the green component), and so on, and the second row of pixel values are arranged.

● BayerGR10/BayerGR12

When the pixel format is set to BayerGR10 or BayerGR12, the value of each pixel in the output image of the camera is 16 bits. According to the location difference, the three components of red, green and blue are respectively represented. The format in the memory is as follows:

G00	R01	G02	R03	G04	.....
B10	G11	B12	G13	B14	.....
.....					

Each pixel is the same as BayerGR8, the difference is that each pixel is made up of two bytes, the first byte is the low 8 bits of the pixel value, and the second byte is the high 8 bits of the pixel value.

● BayerGB8

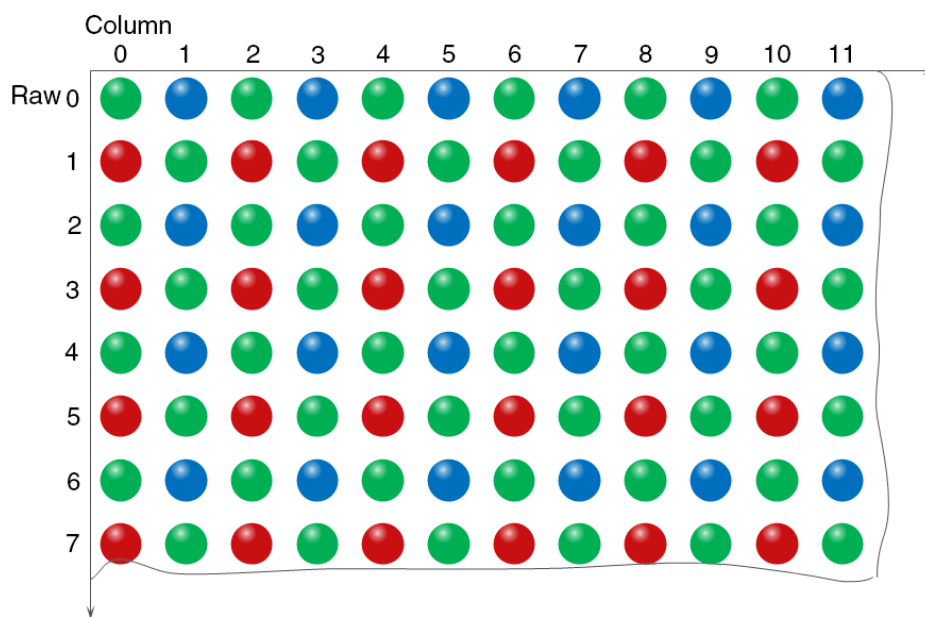

When the pixel format is set to BayerRG8, the value of each pixel in the output image of the camera is 8 bits. According to the location difference, the three components of red, green and blue are respectively represented. The format in the memory is as follows:

G00	B01	G02	B03	G04	.....
R10	G11	R12	G13	R14	.....
.....					

Where G00 is the first pixel value of the first row (for the green component), B01 represents the second pixel value (for the blue component), and so on, so that the first row pixel values are arranged. R10 is the first pixel value of the second row (for the red component), the G11 is the second pixel value (for the green component), and so on, and the second row of pixel values are arranged.

● BayerGB10/BayerGB12

When the pixel format is set to BayerGB10 or BayerGB12, the value of each pixel in the output image of the camera is 16 bits. According to the location difference, the three components of red, green and blue are respectively represented. The format in the memory is as follows:

G00	B01	G02	B03	G04	.....
R10	G11	R12	G13	R14	.....
.....					

Each pixel is the same as BayerGB8, the difference is that each pixel is made up of two bytes, the first byte is the low 8 bits of the pixel value, and the second byte is the high 8 bits of the pixel value.

### 8.3.3. ROI

By setting the ROI of the image, the camera can transmit the specific region of the image, and the output region's parameters include OffsetX, OffsetY, width and height of the output image. The camera only reads the image data from the sensor's designated region to the memory, and transfer it to the host, and the other regions' image of the sensor will be discarded.

By default, the image ROI of the camera is the full resolution region of the sensor. By changing the OffsetX, OffsetY, width and height, the location and size of the image ROI can be changed. The OffsetX refers to the starting column of the ROI, and the OffsetY refers to the starting row of the ROI. Among them, the step of OffsetX and width is 4, and the step of OffsetY and height is 2.

The coordinates of the ROI of the image are defined the 0<sup>th</sup> row and 0<sup>th</sup> column as the origin of the upper left corner of the sensor. As shown in the figure, the OffsetX of the ROI is 4, the OffsetY is 4, the height is 8 and the width is 12.

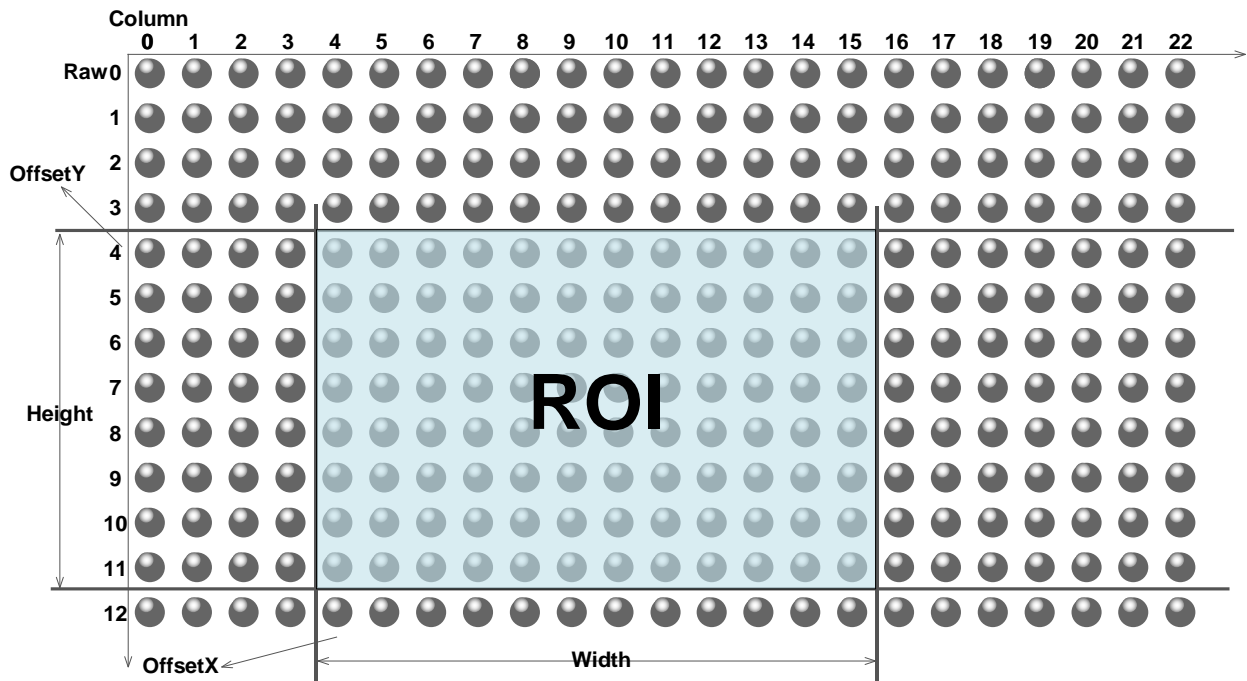

When reducing the height of the ROI, the maximum frame rate of the camera will be raised. Please refer to section 8.5.1 for specific effects on the acquisition frame rate.

### 8.3.4. Auto Exposure/Auto Gain

#### 8.3.4.1. ROI Setting of Auto Exposure/ Auto Gain

For Auto Exposure and Auto Gain, you can specify a portion of the sensor array and only the pixel data from the specified portion will be used for auto function control.

AAROI is defined by the following way:

- AAROIOffsetX: The offset of the X axis direction.
- AAROIOffsetY: The offset of the Y axis direction.
- AAROIWidth: The width of ROI.

AAROIHeight: The height of ROI.

Offset is the offset value that relative to the upper left corner of the image. The step of AAROIOffsetX and AAROIWidth is 4. The step of AAROIOffsetY and AAROIHeight is 2. The setting of the AAROI depends on the size of the current image and cannot exceed the range of the current image. That is to say, assuming the Width and Height are parameters for users captured image, then the AAROI setting need to meet the condition 1:

$$AAROIWidth + AAROIOffsetX \leq Width$$

$$AAROIHeight + AAROIOffsetY \leq Height$$

If condition 1 is not met, the user cannot set the ROI.

The default value of ROI is the entire image, you can set the ROI according to your need. Where the minimum value of AAROIWidth can be set to 16, and the maximum value is equal to the current image width. The minimum value of AAROIHeight can be set to 16, and the maximum value is equal to the current image height, they are all need to meet the condition1.

For example: the current image width is 1024, the height is 1000, and then the ROI setting is:

$$AAROIOffsetX = 100$$

$$AAROIOffsetY = 50$$

$$AAROIWidth = 640$$

$$AAROIHeight = 480$$

The relative position of the ROI and the image is shown in Figure 8-36.

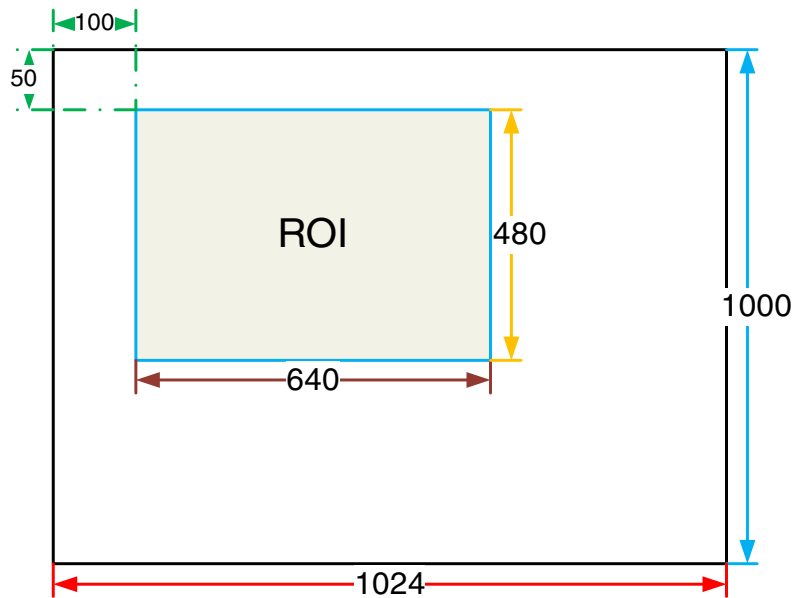

Figure 8-36 An example for the relative position between the ROI and the current image

### 8.3.4.2. Auto Gain

The auto gain can adjust the camera's gain automatically, so that the average gray value in AAROI is achieved to the expected gray value. The auto gain can be controlled by "Once" and "Continuous" mode.

When using the "Once" mode, the camera adjusts the image data in the AAROI to the expected gray value once, then the camera will turn off the auto gain feature. When using the "Continuous" mode, the camera will continuously adjust the gain value according to the data of the AAROI, so that the data in the AAROI is kept near to the expected gray level.

The expected gray value is set by the user, and it is related to the data bit depth. For 8bit pixel data, the expected gray value range is 0-255, for 10bit pixel data, the expected gray value range is 0-1023, and for 12bit pixel data, the expected gray value range is 0-4095.

The camera adjusts the gain value within the range [minimum gain value, maximum gain value] which is set by the user.

The auto gain feature can be used with the auto exposure at the same time, when target grey is changed from dark to bright, the auto exposure adjust is prior to auto gain adjust. Vice versa, when target grey is changed from bright to dark, the auto gain adjust is prior to auto exposure adjust.

#### 8.3.4.3. Auto Exposure

The auto exposure can adjust the camera's exposure time automatically, so that the average gray value in AAROI can achieve to the expected gray value. The auto exposure can be controlled by "Once" and "Continuous" mode.

When using the "Once" mode, the camera adjusts the image data in the AAROI to the expected gray value once, then the camera will close the auto exposure feature. When using the "Continuous" mode, the camera will continuously adjust the exposure time according to the data of the AAROI, so that the data in the AAROI is kept near to the expected gray level.

The expected gray value is set by the user and it is related to the data bit depth. For 8bit pixel data, the expected gray value range is 0-255, and for 12bit pixel data, the expected gray value range is 0-4095.

The camera adjusts the exposure time in the range [minimum exposure time, maximum exposure time] which is set by the user.

The auto exposure feature can be used with the auto gain at the same time, when target grey is changed from dark to bright, the auto exposure adjust is prior to auto gain adjust. Vice versa, when target grey is changed from bright to dark, the auto gain adjust is prior to auto exposure adjust.

#### 8.3.5. Test Pattern

The MARS-U3 series camera supports three test images: gray gradient test image, static diagonal gray gradient test image, and moving diagonal gray gradient test image. When the camera captures in RAW12 mode, the gray value of test image is: the pixel gray value in RAW8 mode multiplies by 16, as the output of pixel gray value in RAW12 mode.

The following three test images are illustrated in the RAW8 mode.

- **GrayFrameRampMoving**

In the gray gradient test image, all the pixels' gray values are the same in the frame. In the adjacent frame, the gray value of the next frame increases by 1 compared to the previous frame, until to 255, and then the

next frame gray value returns to 0, and so on. A printscreen of a single frame is shown in Figure 8-37.



Figure 8-37 Gray gradient test image

- **SlantLineMoving**

In the moving diagonal gray gradient test image, the first pixel value of adjacent row in each frame increases by 1, until the last row. When the pixel gray value increases to 255, the next pixel gray value returns to 0. The first pixel gray value of adjacent column increases by 1, until the last column. When the pixel gray value increases to 255, the next pixel gray value returns to 0.

In the moving diagonal gray gradient test image, in the adjacent frame, the first pixel gray value of the next frame increases by 1 compared to the previous frame. So, in the dynamic image, the image is scrolling to the left. A printscreen of the moving diagonal gray gradient test image is shown in Figure 8-38:

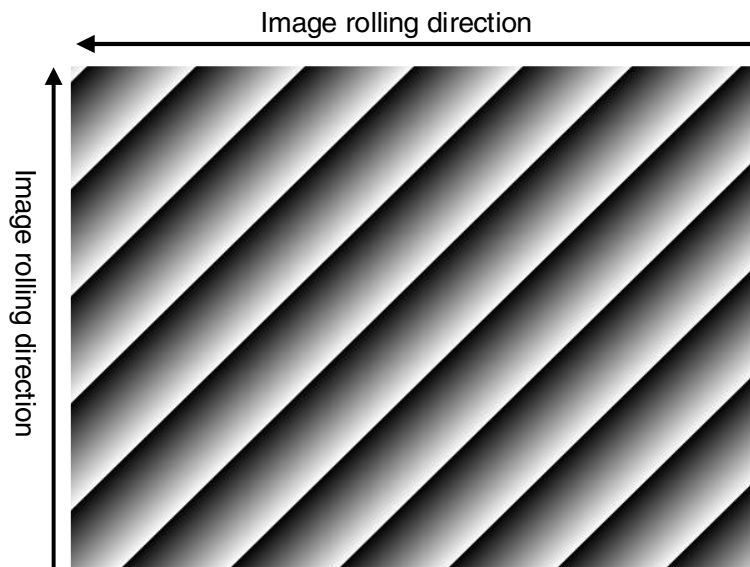

Figure 8-38 Moving diagonal gray gradient test image

- **SlantLine**

In the static diagonal gray gradient test image, the first pixel gray value is 0, the first pixel gray value of adjacent row increases by 1, until the last row. When the pixel gray value increases to 255, the next pixel gray value returns to 0. The first pixel gray value of adjacent column increases by 1, until the last column. When the pixel gray value increases to 255, the next pixel gray value returns to 0.

Compared to the moving diagonal gray gradient test image, in the adjacent image of the static diagonal gray gradient test image, the gray value in the same position remains unchanged. A screenshot of the static diagonal gray gradient test image is shown in Figure 8-39.



Figure 8-39 Static diagonal gray gradient test image

### 8.3.6. User Set Control

By setting various parameters of the camera, the camera can perform the best performance in different environments. There are two ways to set parameters: one is to modify the parameters manually, and the other is to load parameter set. In order to save the specific parameters of the users, avoiding to set the parameters every time when you open the camera, the MARS-U3 series camera provides a function to save the parameter set, which can easily save the parameters that the user use, including the control parameters that the camera needed. There three types of configuration parameters: the currently effective configuration parameters, the vendor default configuration parameters (Default), and the user configuration parameters (UserSet).

Three operations can be performed on the configuration parameters, including save parameters (UserSetSave), load parameters (UserSetLoad), and set the startup parameter set (UserSetDefault). The UserSetSave is to save the effective configuration parameters to the user configuration parameter set which is set by the user. The UserSetLoad is to load the vendor default configuration parameters (Default) or the user configuration parameters (UserSet) to the current effective configuration parameters. The UserSetDefault is refer to the user can specify a set of parameters which to be loaded into the effective configuration parameters automatically when the camera is reset or powered on. And the camera can work under this set of parameters. This set of parameters can be vendor default configuration parameters or user configuration parameters.

#### 1) The type of configuration parameters

The type of configuration parameters includes: the current effective configuration parameters, vendor default configuration parameters, user configuration parameters.

The current effective configuration parameters: Refers to the current control parameters used by the camera. Using API function or Demo program to modify the current control parameters of the camera is to modify the effective configuration parameters. The effective parameters are stored in volatile memory of the camera, so when the camera is reset or powered on again, the effective configuration parameters will be lost.

The vendor default configuration parameters (Default): Before the camera leaves the factory, the camera manufacturer will test the camera to assess the camera's performance and optimize the configuration



parameters of the camera. The vendor default configuration parameters are the camera configuration parameters optimized by the vendor in a particular environment, these parameters are stored in the non-volatile memory of the camera, so when the camera is reset or powered on again, the effective configuration parameters will not be lost, and these parameters cannot be modified.

The user configuration parameters (UserSet): The effective parameters are stored in volatile memory of the camera, so when the camera is reset or powered on again, the effective configuration parameters will be lost. You can store the effective configuration parameters to the user configuration parameters, the user configuration parameters are stored in the non-volatile memory of the camera, so when the camera is reset or powered on again, the user configuration parameters will not be lost. The MARS-U3 series camera can store a set of user configuration parameters.

## 2) The operation of configuration parameters

The operations for configuration parameters include the following three types: save parameters, load parameters and set the UserSetDefault.

**Save parameters (UserSetSave):** Save the current effective configuration parameters to the user configuration parameters. The storage steps are as follows:

- 1) Modify the camera's configuration parameters, until the camera runs to the user's requirements.
- 2) Use UserSetSelector to select UserSet0. Execute UserSetSave command.

The camera's configuration parameters which are saved in the user parameter set include:

- Gain
- ExposureTime
- PixelFormat
- OffsetX, OffsetY, ImageWidth, ImageHeight
- EventNotification
- TriggerMode, TriggerSource, TriggerPolarity, TriggerDelay
- TriggerFilterRaisingEdge, TriggerFilterFallingEdge
- LineMode, LineInverter, LineSource, UserOutputValue
- ChunkModeActive
- TestPattern
- ExpectedGrayValue
- ExposureAuto, AutoExposureTimeMax, AutoExposureTimeMin
- GainAuto, AutoGainMax, AutoGainMin
- AAROIOffsetX, AAROIOffsetY, AAROIWidth, AAROIHeight
- BalanceWhiteAuto, AWBLampHouse
- AWBROIOffsetX, AWBROIOffsetY, AWBROIWidth, AWBROIHeight
- BalanceRatio(R/G/B)

- LUT

**Load parameters (UserSetLoad):** Load the vendor default configuration parameters or the user configuration parameters into the effective configuration parameters. After this operation is performed, the effective configuration parameters will be covered by the loaded parameters which are selected by the user, and the new effective configuration parameters are generated. The operation steps are as follows:

- 1) Use UserSetSelector to select Default or UserSet0.
- 2) Execute UserSetLoad command to load the UserSet specified by UserSetSelector to the device and makes it active.

**Change startup parameter set (UserSetDefault):** The user can use UserSetDefault to select Default or UserSet0 as the UserSetDefault. When the camera is reset or powered on again, the parameters in the UserSetDefault will be loaded into the effective configuration parameters.

### 8.3.7. Device User ID

The MARS-U3 series camera provides programmable device user ID function, the user can set a unique identification for the camera, and can open and control the camera by the unique identification.

The user-defined name is a string which maximum length is 16 bytes, the user can set it by the following ways:

- 1) Set by the GalxyView, as shown in the Figure 8-40.

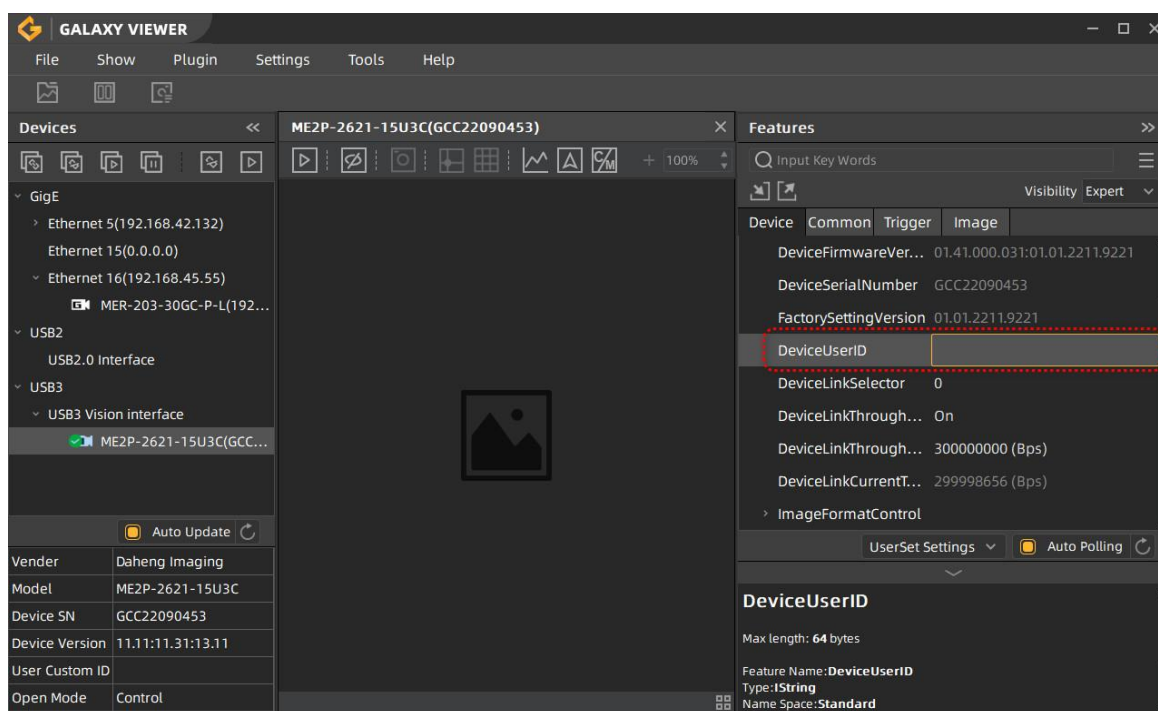

Figure 8-40 GalxyView software

- 2) Set by calling the software interface, for details please see the Programmer's Guide.



When using multi-cameras at the same time, it is necessary to ensure the uniqueness of the user-defined name of each camera, otherwise, an exception will occur when the camera is opened.

### 8.3.8. Timestamp

The timestamp feature counts the number of ticks generated by the camera's internal device clock. As soon as the camera is powered on, it starts generating and counting clock ticks. The counter is reset to 0 whenever the camera is powered off and on again. Some of the camera's features use timestamp values, such as event, frame information, and timestamps can be used to test the time spent on some of the camera's operations.

The unit of timestamp is ns.

### 8.3.9. Binning

The feature of Binning is to combine multiple pixels adjacent to each other in the sensor into a single value, and process the average value of multiple pixels or sum the multiple pixel values, which may increase the signal-to-noise ratio or the camera's response to light.

- **How Binning Works**

On color cameras, the camera combines (sums or averages) the pixel values of adjacent pixels of the same color:

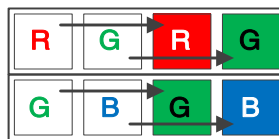

Figure 8-41 Horizontal color Binning by 2

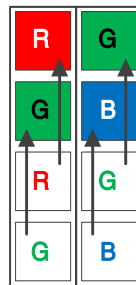

Figure 8-42 Vertical color Binning by 2

When the horizontal Binning factor and the vertical Binning factor are both set to 2, the camera combines the adjacent 4 sub-pixels of the same color according to the corresponding positions, and outputs the combined pixel values as one sub-pixel.

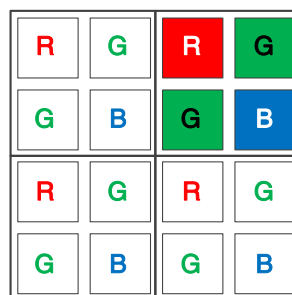

Figure 8-43 Horizontal and vertical color Binning by 2x2

On monochrome cameras, the camera combines (sums or averages) the pixel values of directly adjacent pixels:

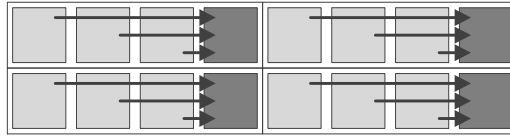

Figure 8-44 Horizontal mono Binning by 4

- **Binning Factors**

Two types of Binning are available: horizontal Binning and vertical Binning. You can set the Binning factor in one or two directions.

Horizontal Binning is the processing of pixels in adjacent rows.

Vertical Binning is the processing of pixels in adjacent columns.

Binning factor 1: Disable Binning.

Binning factor 2, 4: Indicate the number of rows or columns to be processed.

For example, the horizontal Binning factor 2 indicates that the Binning is enabled in the horizontal direction, and the pixels of two adjacent rows are processed.

- **Binning Modes**

The Binning mode defines how pixels are combined when Binning is enabled. Two types of the Binning mode are available: Sum and Average.

Sum: The values of the affected pixels are summed and then output as one pixel. This improves the signal-to-noise ratio, but also increases the camera's response to light.

Average: The values of the affected pixels are averaged. This greatly improves the signal-to-noise ratio without affecting the camera's response to light.

- **Considerations when Using Binning**

- 1) Effect on ROI settings

When Binning is used, the value of the current ROI of the image, the maximum ROI of the image, the auto function ROI, and the auto white balance ROI will change. The changed value is the original value (the value before the setting) divided by the Binning factor.

For example, assume that you are using a camera with a 1200 x 960 sensor. Horizontal Binning by 2 and vertical Binning by 2 are enabled. In this case, the maximum ROI width is 600 and the maximum ROI height is 480.

- 2) Increased response to light

Using Binning with the Binning mode set to **Sum** can significantly increase the camera's response to light. When pixel values are summed, the acquired images may look overexposed. If this is the case, you can

reduce the lens aperture, the intensity of your illumination, the camera's exposure time setting, or the camera's gain setting.

3) Possible image distortion

Objects will only appear undistorted in the image if the numbers of binned rows and columns are equal. With all other combinations, objects will appear distorted. For example, if you combine vertical Binning by 2 with horizontal Binning by 4, the target objects will appear squashed.

4) Mutually exclusive with Decimation

Binning and Decimation cannot be used simultaneously in the same direction. When the horizontal Binning value is set to a value other than 1, the horizontal Decimation feature cannot be used. When the vertical Binning value is set to a value other than 1, the vertical Decimation feature cannot be used.

### 8.3.10. Decimation

The Decimation can reduce the number of sensor pixel columns or rows that are transmitted by the camera, reducing the amount of data that needs to be transmitted and reducing bandwidth usage.

- **How Vertical Decimation Works**

On mono cameras, if you specify a vertical Decimation factor of  $n$ , the camera transmits only every  $n^{\text{th}}$  row. For example, when you specify a vertical Decimation factor of 2, the camera skips row 1, transmits row 2, skips row 3, and so on.

On color cameras, if you specify a vertical Decimation factor of  $n$ , the camera transmits only every  $n^{\text{th}}$  pair of rows. For example, when you specify a vertical Decimation factor of 2, the camera skips rows 1 and 2, transmits rows 3 and 4, skips rows 5 and 6, and so on.

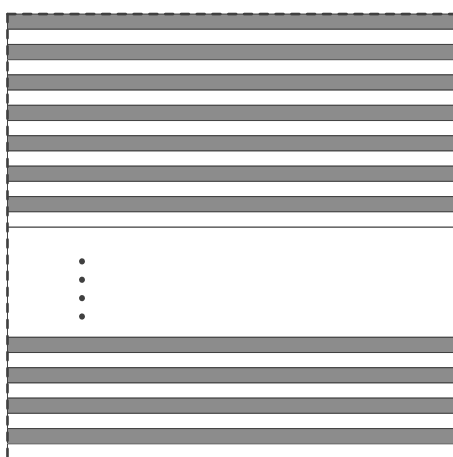

Figure 8-45 Mono camera vertical Decimation

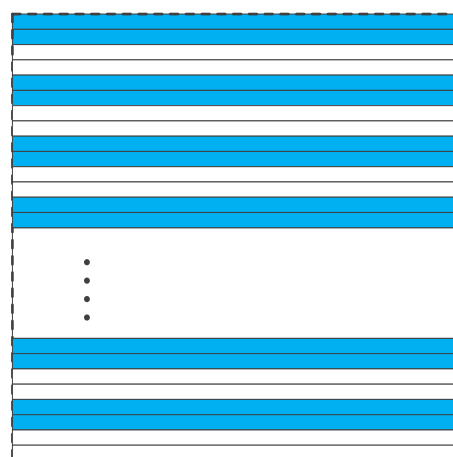

Figure 8-46 Color camera vertical Decimation

As a result, the image height is reduced. For example, enabling vertical Decimation by 2 halves the image height. The camera automatically adjusts the image ROI settings.

Vertical Decimation significantly increases the camera's frame rate. For details, please refer to the section 9.4 Frame Rate Calculation Tool.

- **How Horizontal Decimation Works**

On mono cameras, if you specify a horizontal Decimation factor of  $n$ , the camera transmits only every  $n^{\text{th}}$  column. For example, if specify set a horizontal Decimation factor of 2, the camera skips column 1, transmits column 2, skips column 3, and so on.

On color cameras, if you specify a horizontal Decimation factor of  $n$ , the camera transmits only every  $n^{\text{th}}$  pair of columns. For example, if you specify a horizontal Decimation factor of 2, the camera skips columns 1 and 2, transmits columns 3 and 4, skips columns 5 and 6, and so on.

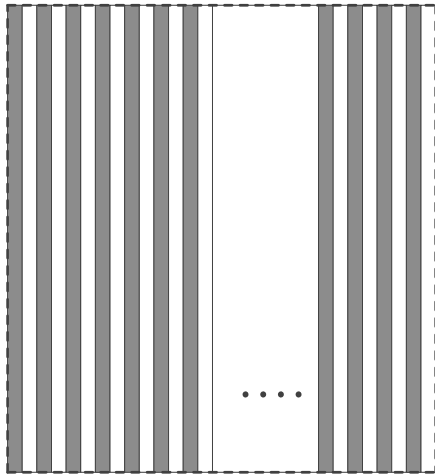

Figure 8-47 Mono camera horizontal Decimation

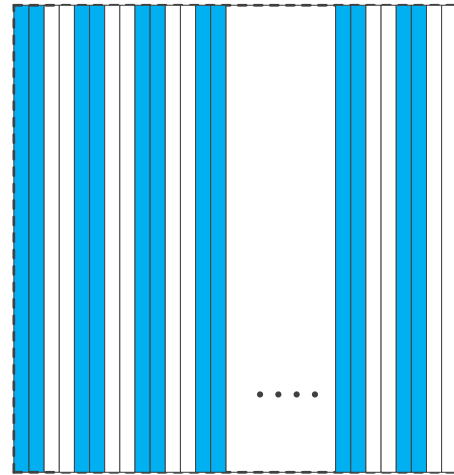

Figure 8-48 Color camera horizontal Decimation

As a result, the image width is reduced. For example, enabling horizontal Decimation by 2 halves the image width. The camera automatically adjusts the image ROI settings.

Horizontal Decimation does not (or only to a very small extent) increase the camera's frame rate.

- **Configuring Decimation**

To configure vertical Decimation, enter a value for the DecimationVertical parameter. To configure horizontal Decimation, enter a value for the DecimationHorizontal parameter.

The value of the parameters defines the Decimation factor. Depending on your camera model, the following values are available:

1. Disable Decimation.
2. Enable Decimation.

- **Considerations When Using Decimation**

- 1) Effect on ROI settings

When you are using Decimation, the settings for your image ROI refer to the resulting number of rows and columns. Taking MARS-4470-8U3M/C as an example, the camera's default resolution is 8192×5460. When horizontal Decimation by 2 and vertical Decimation by 2 are enabled, the maximum ROI width would be 4096×2728.

2) Reduced resolution

Using Decimation effectively reduces the resolution of the camera's imaging sensor. Taking MARS-4470-8U3M/C as an example, the camera's default resolution is 8192×5460. When horizontal Decimation by 2 and vertical Decimation by 2 are enabled, the effective resolution of the sensor is reduced to 4096×2728.

3) Possible image distortion

The displayed image will not be distorted if the vertical and horizontal Decimation factors are equal. When only horizontal Decimation or vertical Decimation is used, the displayed image will be reduced in width or height.

4) Mutually exclusive with Binning

Decimation and Binning cannot be used simultaneously in the same direction. When the horizontal Decimation value is set to a value other than 1, the horizontal Binning feature cannot be used. When the vertical Decimation value is set to a value other than 1, the vertical Binning feature cannot be used.

8.3.11. Reverse X and Reverse Y

The Reverse X and Reverse Y features can mirror acquired images horizontally, vertically, or both.

- Enabling Reverse X

To enable Reverse X, set the **ReverseX** parameter to **true**. The camera mirrors the image horizontally.



Figure 8-49 The original image



Figure 8-50 Reverse X enabled

- Enabling Reverse Y

To enable Reverse Y, set the **ReverseY** parameter to **true**. The camera mirrors the image vertically.





Figure 8-51 The original image

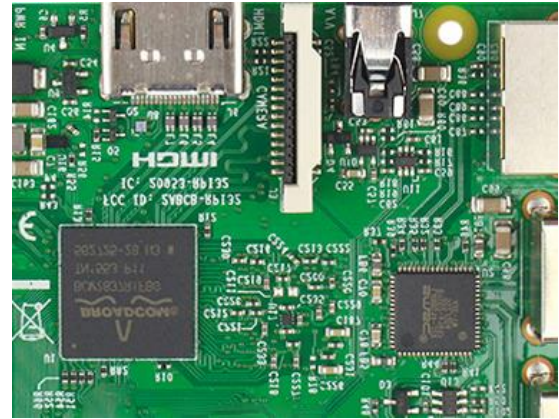

Figure 8-52 Reverse Y enabled

- Enabling Reverse X and Y

To enable Reverse X and Y, set the **ReverseX** and **ReverseY** parameters to **true**. The camera mirrors the image horizontally and vertically.



Figure 8-53 The original image

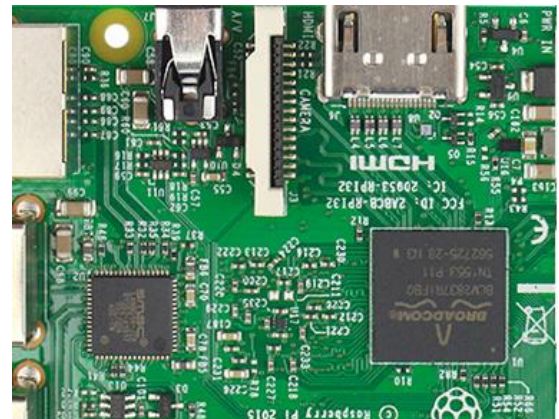

Figure 8-54 Reverse X and Y enabled

- Using Image ROI with Reverse X or Reverse Y

If you have specified an image ROI while using Reverse X or Reverse Y, you must bear in mind that the position of the ROI relative to the sensor remains the same. Therefore, the camera acquires different portions of the image depending on whether the Reverse X or the Reverse Y feature are enabled:



Figure 8-55 The original image



Figure 8-56 Reverse X enabled



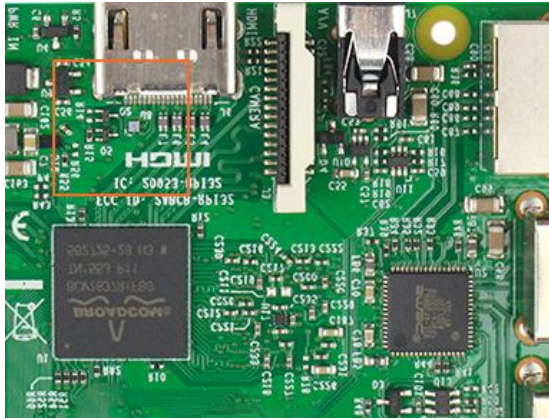

Figure 8-57 Reverse Y enabled

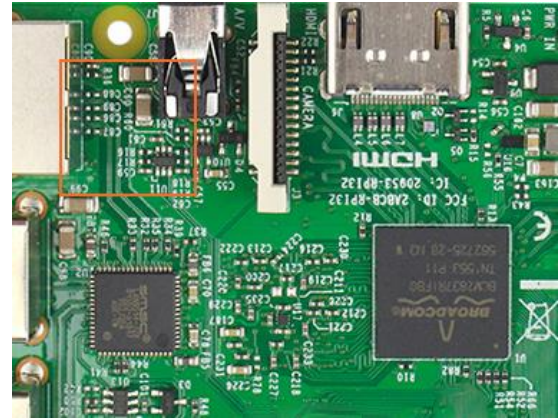

Figure 8-58 Reverse X and Y enabled

- **Pixel Format Alignment**

The alignment of the Bayer format does not change when the camera is using the reverse feature.

### 8.3.12. Digital Shift

The Digital Shift can multiply the pixel values by  $2^n$  of the images.

This increases the brightness of the image. If your camera doesn't support the digital shift feature, you can use the Gain feature to achieve a similar effect.

- **How Digital Shift Works**

Configuring a digital shift factor of  $n$  results in a logical left shift by  $n$  on all pixel values. This has the effect of multiplying all pixel values by  $2^n$ .

If the resulting pixel value is greater than the maximum value possible for the current pixel format (e.g., 255 for an 8-bit pixel format, 1023 for a 10-bit pixel format, and 4095 for a 12-bit pixel format), the value is set to the maximum value.

- **Configuring Digital Shift**

To configure the digital shift factor, enter the expected value for the **DigitalShift** parameter.

By default, the parameter is set to 0, i.e., digital shift is disabled. When the **DigitalShift** parameter is set to 1, the camera will shift the pixel value to the left by 1 bit. When the **DigitalShift** parameter is set to 2, the camera will shift the pixel value to the left by 2 bits.

- **Considerations When Using Digital Shift**

Example 1: Digital Shift by 1, 12-Bit Image Data

	MSB											LSB	
	bit 11	bit 10	bit 9	bit 8	bit 7	bit 6	bit 5	bit 4	bit 3	bit 2	bit 1	bit 0	
Binary	0	0	0	0	0	0	0	1	0	1	1	0	Raw pixel value: 22

	MSB											LSB	
	bit 11	bit 10	bit 9	bit 8	bit 7	bit 6	bit 5	bit 4	bit 3	bit 2	bit 1	bit 0	
Binary	0	0	0	0	0	0	1	0	1	1	0	0	Shift pixel value: 44

The least significant bit in each 12-bit image data is set to 0.

**Example 2: Digital Shift by 2, 8-bit Image Data**

Assume that your camera has a maximum pixel bit depth of 12-bit, but is currently using an 8-bit pixel format. In this case, the camera first performs the digital shift calculation on the 12-bit image data. Then, the camera transmits the 8 most significant bits.

	MSB											LSB	
	bit 11	bit 10	bit 9	bit 8	bit 7	bit 6	bit 5	bit 4	bit 3	bit 2	bit 1	bit 0	
Binary	0	0	1	0	1	1	0	1	0	1	1	0	Raw pixel value(8bit): 45
													Raw pixel value(12bit): 726

	MSB											LSB	
	bit 11	bit 10	bit 9	bit 8	bit 7	bit 6	bit 5	bit 4	bit 3	bit 2	bit 1	bit 0	
Binary	1	0	1	1	0	1	0	1	-	-	-	-	Shift pixel value(8bit): 181

**Example 3: Digital Shift by 1, 12-bit Image Data, High Value**

Assume that your camera is using a 12-bit pixel format. Also assume that one of your original pixel values is 2839.

	MSB											LSB	
	bit 11	bit 10	bit 9	bit 8	bit 7	bit 6	bit 5	bit 4	bit 3	bit 2	bit 1	bit 0	
Binary	1	0	1	1	0	0	0	1	0	1	1	1	Raw pixel value: 2839

	MSB											LSB	
	bit 11	bit 10	bit 9	bit 8	bit 7	bit 6	bit 5	bit 4	bit 3	bit 2	bit 1	bit 0	
Binary	1	1	1	1	1	1	1	1	1	1	1	1	Shift pixel value: 4095

If you apply digital shift by 1 to this pixel value, the resulting value is greater than the maximum possible value for 12-bit pixel formats. In this case, the value is set to the maximum value, i.e., all bits are set to 1.

**8.3.13. Acquisition Status**

The Acquisition Status feature can determine whether the camera is waiting for trigger signals. This is useful if you want to optimize triggered image acquisition and avoid over triggering.

To determine if the camera is currently waiting for trigger signals.

- a) Set the **AcquisitionStatusSelector** parameter to the expected trigger type. Two trigger types are available: **FrameTriggerWait** and **AcquisitionTriggerWait**. For example, if you want to determine if the camera is waiting for **FrameStartTrigger** signals, set the **AcquisitionStatusSelector** to **FrameTriggerWait**. If you want to determine if the camera is waiting for **FrameBurstStartTrigger** signals, set the **AcquisitionStatusSelector** to **AcquisitionTriggerWait**.
- b) If the **AcquisitionStatus** parameter is **true**, the camera is waiting for a trigger signal of the trigger type selected. If the **AcquisitionStatus** parameter is **false**, the camera is busy.

### 8.3.14. Black Level

The Black Level can change the overall brightness of an image by changing the gray values of the pixels by a specified amount. Currently, the application range of the black level value can only be selected as all pixels, and pixel selection is not supported.

The lower the black level, the darker the corresponding image, the higher the black level, the brighter the corresponding image.

### 8.3.15. Remove Parameter Limits

The range of camera parameters is usually limited, and these factory limits are designed to ensure the best camera performance and high image quality. However, for certain use cases, you may want to specify parameter values outside of the factory limits. You can use the remove parameter limits feature to expand the parameter range. The features of the extended range supported by different cameras may be different and the range may be different, as shown in Table 8-3.

Model	Features	Set the switch to off	Set the switch to on
MARS-3250-12U3M/C MARS-4470-8U3M/C	Exposure	162~1000000	162~15000000
	Auto Exposure	162~1000000	162~15000000
	Gain	0~24	0~24
	Auto Gain	0~24	0~24
	Black Level	0~4095	0~4095
	Sharpness	0~3	0~63
	White Balance component factor	0~15.996	0~63.996
	Auto White Balance	0~15.996	0~63.996

Table 8-3 Parameter range of features supported before and after Remove Parameter Limits

### 8.3.16. User Data Area

The user data area is a FLASH data area reserved for the user, and the user can use the area to save algorithm factors, parameter configurations, etc.

The user data area is 16K bytes and is divided into 4 data segments, each of which is 4K bytes. The user can access the user data area through the API interface. The data is saved to the camera flash area immediately after being written, and the data will not disappear after the camera is powered off.

### 8.3.17. Timer

The camera only supports one timer (Timer1), which can be started by a specified event or signal (only ExposureStart signal is supported). The Timer can configure a timer output signal that goes high on a specific event or signal and goes low after a specific duration. And the timer is cleared when the output signal goes low. A schematic diagram of the timer working process is as follows:

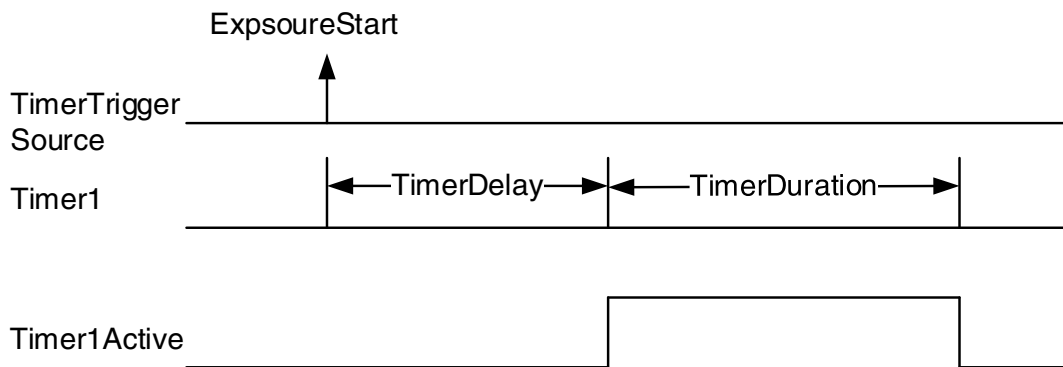

Figure 8-59 Timer1Active schematic diagram

The timer configuration process is as follows:

1. Set TimerSelector, currently only Timer1 supported.
2. Set LineSelector.
3. Set the LineSource to Timer1Active.
4. Set TimerTriggerSource, currently only ExposureStart supported.
5. Set TimerDelay, the range of TimerDelay is [0, 16777215], the unit is  $\mu\text{s}$ .
6. Set TimerDuration, the range of TimerDuration is [0, 16777215], the unit is  $\mu\text{s}$ .



Note:

- 1) From the start of the timer to the full output of Timer1Active, this process will not be interrupted by the ExposureStart signal, and Timer1Active must be completely output to start timing according to the next ExposureStart signal. As shown in the figure below, the red ExposureStart signals are ignored.

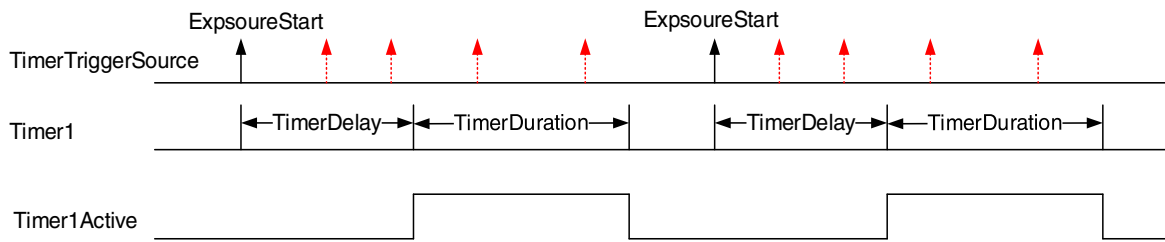

Figure 8-60 The relationship of Timer1Active and ExposureStart signal

- 2) After the acquisition is stopped, the timer is immediately cleared and the Timer1Active signal goes low immediately.

### 8.3.18. Counter

The camera only supports one counter (Counter1), which can count the number of FrameTrigger, AcquisitionTrigger and FrameStart signals received by the camera. The counter starts counting from 0. You can select one of the above three signals to count by CounterEventSource. The FrameTrigger and AcquisitionTrigger signals of the counter statistics refer to the signals that have been triggered for filtering without a trigger delay.

If CounterValue is enabled, the statistical data can be inserted into the frame information and output with the image.

The counter can be reset by an external signal. The reset source is selected by CounterResetSource. Currently, the CounterResetSource option supports Off, SoftWare, Line0, Line2, and Line3. Among them, Off means no reset, SoftWare means software reset, Line0, Line2 or Line3 means reset through IO port input signal. The polarity of the reset signal only supports RisingEdge, which means reset the Counter on the rising edge of the reset signal.

Counter configuration:

1. Set CounterSelector, currently only Counter1 supported.
2. Set CounterEventSource, the values that can be set are FrameStart, FrameTrigger, AcquisitionTrigger.
3. Set CounterResetSource, the values that can be set are Off, SoftWare, Line0, Line2, Line3.
4. Set CounterResetActivation, currently only RisingEdge supported.



- 1) After the acquisition is stopped, the Counter continues to work, will not be cleared, and it will be cleared when the camera is powered off.
- 2) CounterReset is used to software reset the counter.

## 8.4. Image Processing

### 8.4.1. Light Source Preset

MARS-GT cameras support light source preset function, and provides Off mode, Custom mode, and four specified common color temperature light source modes. The camera provides the corresponding white

balance coefficient and color transformation coefficient in the four specified color temperature light source modes.

- **Off Mode**

The camera does not perform white balance and color conversion processing on the image by default.

- **Custom Mode**

The camera does not perform white balance and color conversion processing on the image by default.

Users can perform automatic white balance, or manually input white balance coefficients, and it supports color conversion enable control and manually input color conversion coefficients.

- **Daylight-6500K**

When the user selects **Daylight-6500K** in the light source preset, the camera will perform white balance processing on the image by default. If the external environment light source used is D65 light source, the image will not produce color deviation.

Even if the current light source is selected as the light source preset, users can also manually adjust the white balance coefficient.

Users can turn on the color conversion enable switch and calibrate according to the color conversion coefficient of the **Daylight-6500K** light source (manual input of color correction coefficients is not supported).

The option operation of **Daylight5000K**, **CoolWhiteFluorescence**, **INCA** is the same as **Daylight-6500K**.

## 8.4.2. Auto White Balance

The MARS-U3 camera supports automatic white balance function, which can be controlled in "Once" or "Continuous" mode.

### 8.4.2.1. Auto White Balance ROI

Auto White Balance feature use the image data from AWBROI to calculate the white balance ratio, and then the white balance ratio is used to adjust the components of the image.

ROI is defined in the following way:

AWBROIOffsetX:	The offset of the X axis direction.
AWBROIOffsetY:	The offset of the Y axis direction.
AWBROIWidth:	The width of ROI.
AWBROIHeight:	The height of ROI.

Offset is the offset value that relative to the upper left corner of the image. Where the step of AWBROIOffsetX and AWBROIWidth is 4, the step of AWBROIOffsetY and AWBROIHeight is 2. The ROI setting depends on the current image and cannot exceed the current image range. Assuming the current image width is Width, the image height is Height, then the ROI setting need to meet the following condition 2:

$$AWBROIWidth + AWBROIOffsetX \leq Width$$

$$AWBROIHeight + AWBROIOffsetY \leq Height$$

If condition 2 is not met, the user cannot set the ROI.

The default value of ROI is the entire image, you can set the "white dot" area (ROI) according to your need. Where the minimum value of AWBROIWidth can be set is 16, the maximum value is equal to the current image width. The minimum value of AWBROIHeight can be set is 16, the maximum value is equal to the current image height, they are all need to meet the condition 2.

Assuming the current image width is 1024, the height is 1000, and then the "white dot" area ROI setting is:

$$AWBROIOffsetX = 100$$

$$AWBROIOffsetY = 50$$

$$AWBROIWidth = 640$$

$$AWBROIHeight = 480$$

The relative position of the ROI and the image is shown in Figure 8-61.

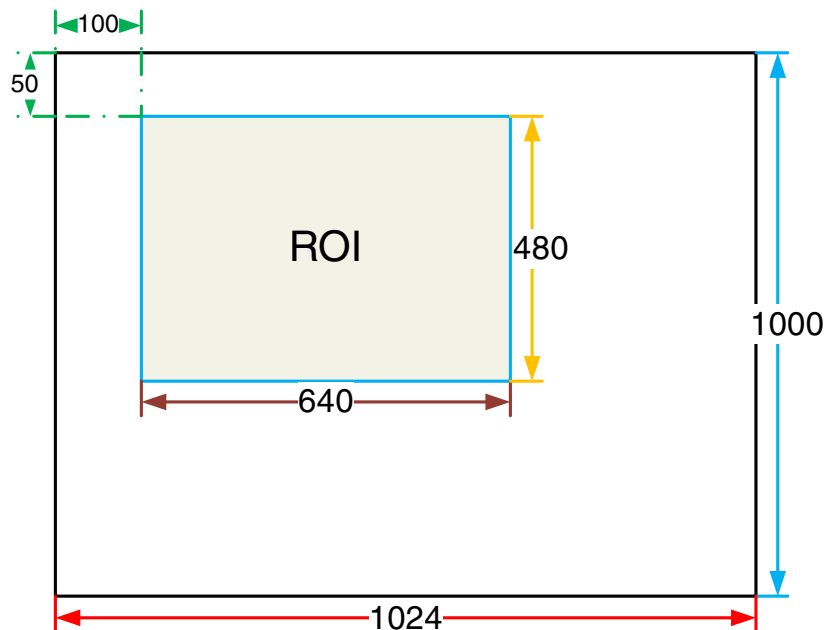

Figure 8-61 An example for the relative position between the ROI and the current image

#### 8.4.2.2. Auto White Balance Adjustment

The auto white balance can be set to "Once" or "Continuous" mode. When using the "Once" mode, the camera just adjusts the white balance ratio once, when using the "Continuous" mode, the camera continuously adjusts the white balance ratio based on the data in AWBROI.

The auto white balance feature can also select the color temperature. When the color temperature of the selection is "Adaptive", the data in ROI always adjusting the red, green and blue to the same. When selecting the specific color temperature, the camera adjusts the factor according to the light source, so

that the hue of the ROI is the same as the hue of the light source. That is: high temperature is cold, low color temperature is warm.

The auto white balance feature is only available on color sensors.

### 8.4.3. Color Transformation Control

The Color Transformation is used to correct the color information delivered by the sensor, improve the color reproduction of the camera, and make the image closer to the human visual perception.



Figure 8-62 Color template

The user can use a color template containing 24 colors and shoot this color template with a camera, the RGB value of each color may be different from the standard RGB value of the standard color template, the vendor can use the software or hardware to convert the RGB value that is read to the standard RGB value. Because the color space is continuous, all the other RGB values that are read can be converted to the standard RGB values by using the mapping table created by the 24 colors.

#### 1) Prerequisites

For the color transformation to work properly, the white balance must first be configured appropriately.

#### 2) Configuring color transformation

There are two modes for configuring color transformation: default mode (RGBtoRGB), user-defined mode (User).

**RGBtoRGB:** Default color transformation parameters provided to the camera when it leaves the factory.

**User:**

- Set the **ColorTransformationValueSelector** parameter to the expected position in the matrix, e.g., Gain00.
- Enter the expected value for the **ColorTransformationValue** parameter to adjust the value at the selected position. The parameter's value range is -4.0 to +4.0.

In user mode, the user can input the color transformation value according to the actual situation to achieve the color transformation effect.

#### 3) How it works

The color transformation feature uses a transformation matrix to deliver modified red, green, and blue pixel data for each pixel.



The transformation is performed by premultiplying a 3 x 1 matrix containing R, G, and B pixel values by a 3 x 3 matrix containing the color transformation values:

$$\begin{bmatrix} \text{Gain00} & \text{Gain01} & \text{Gain02} \\ \text{Gain10} & \text{Gain11} & \text{Gain12} \\ \text{Gain20} & \text{Gain21} & \text{Gain22} \end{bmatrix} \begin{bmatrix} R \\ G \\ B \end{bmatrix} = \begin{bmatrix} R' \\ G' \\ B' \end{bmatrix}$$

4) Effect images



Figure 8-63 Before color transformation



Figure 8-64 After color transformation

8.4.4. Gamma

The Gamma can optimize the brightness of acquired images for display on a monitor.

1) Prerequisites

If the **GammaEnable** parameter is available, it must be set to **true**.

2) How it works

The camera applies a Gamma correction value ( $\gamma$ ) to the brightness value of each pixel according to the following formula (red pixel value  $R$  of a color camera shown as an example):

$$R_{\text{corrected}} = \left( \frac{R_{\text{uncorrected}}}{R_{\text{max}}} \right)^\gamma \times R_{\text{max}}$$

The maximum pixel value ( $R_{\text{max}}$ ) equals, e.g., 255 for 8-bit pixel formats, 1023 for 10-bit pixel formats or 4095 for 12-bit pixel formats.

3) Enabling Gamma correction

After enabling Gamma correction, set **GammaValue** to change the image brightness. The range of **GammaValue** is 0 to 4.00.

- a) Gamma = 1.0: the overall brightness remains unchanged.
- b) Gamma < 1.0: the overall brightness increases.
- c) Gamma > 1.0: the overall brightness decreases.

In all cases, black pixels (gray value = 0) and white pixels (gray value = maximum) will not be adjusted.



If you enable Gamma correction and the pixel format is set to a 10-bit or 12-bit, some image information will be lost. Pixel data output will still be 10-bit or 12-bit, but the pixel values will be interpolated during the Gamma correction process, resulting in loss of accuracy and loss of image information. If the Gamma feature is required and no image information is lost, avoid using the Gamma feature in 10-bit or 12-bit pixel format.

#### 4) Additional parameters

Depending on your camera model, the following additional parameters are available:

- a) GammaEnable: Enable or disable Gamma correction.
- b) GammaMode: You can select one of the following Gamma correction modes:

User: The Gamma correction value can be set as expected.

sRGB: The camera's internal default Gamma correction value. This feature is used with the color transformation feature to convert images from RGB to sRGB. It is recommended to adjust Gamma to sRGB mode after enabling the color transformation feature.

#### 8.4.5. Sharpness

The sharpness algorithm integrated in the camera can significantly improve the definition of the edges of the image. The higher the definition, the clearer the contour corresponding to the image. This feature can improve the accuracy of image analysis, thus improving the recognition rate of edge detection and OCR.

- Enable sharpness

ON means that the sharpness feature is enabled.

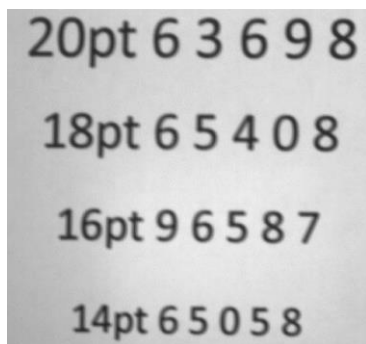

Figure 8-65 Before sharpness adjustment

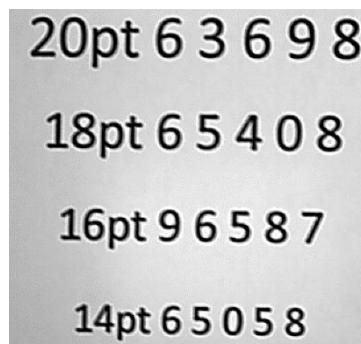

Figure 8-66 After sharpness adjustment

- Sharpness adjustment

Adjust the sharpness value to adjust the camera's sharpness to the image. The adjustment range is 0-3.0. The larger the value, the higher the sharpness.

Camera models that support this feature:

Models
MARS-3250-12U3M
MARS-4470-8U3M

### 8.4.6. Lookup Table

When the analog signal that is read out by the sensor has been converted via ADC, generally, the raw data bit depth is larger than 8 bits, there are 12 bits, 10 bits, etc. The feature of lookup table is to replace some pixel values in the 8 bits, 10 bits, and 12 bits images by values defined by the user.

The lookup table can be a linear lookup table or a non-linear lookup table, created entirely by the user.

You can also use the **LutValueAll** function to create an entire lookup table.

#### 1) How it works

- a) LUT is short for "lookup table", which is basically an indexed list of numbers.
- b) In the lookup table you can define replacement values for individual pixel values. For example, you can replace a gray value of 0 (= minimum gray value) by a gray value of 1023 (= maximum gray value for 10-bit pixel formats). This changes all black pixels in your images to white pixels.
- c) Setting a user-defined LUT can optimize the luminance of images. By defining the replacement values in advance and storing them in the camera to avoid time-consuming calculations. The camera itself has a factory default lookup table, and the default lookup table does not affect image luminance.

#### 2) Creating the user-defined LUT

To create a lookup table, you need to determine the range of **LUTIndex** and **LUTValue** parameters by the maximum pixel format supported by the currently used camera.

- a) On cameras with a maximum pixel bit depth of 12 bits

The **LUTIndex** selectable item is 0-4095, each **LUTIndex** corresponds to a **LUTValue**, and the **LUTValue** range is [0,4095].

- b) On cameras with a maximum pixel bit depth of 10 bits

The **LUTIndex** selectable item is 0-1023, each **LUTIndex** corresponds to a **LUTValue**, and the **LUTValue** range is [0,1023].

Create a user-defined lookup table with the following steps:

- 1) Select the lookup table to use. Since there is only one user-defined lookup table in the camera, there is no need to select it by default.
- 2) Set the **LUTIndex** parameter to the pixel value that you want to replace with a new value.
- 3) Set the **LUTValue** parameter to the new pixel value.
- 4) Repeat steps 1 and 2 for all pixel values that need to be changed to set the parameters to the target pixel values in turn.
- 5) Set the **LutEnable** parameter to **true** means that the lookup table feature is enabled. The default is disabled.



If you want to replace all pixel values, it is recommended to use the **LUTValueAll** function. See the **LutValueAll** sample code in the Development User Manual for details.

### 8.4.7. Flat Field Correction

During the use of the camera, there may be various inconsistencies in the image, which are mainly reflected in the following aspects:

- 1) Inconsistent response of individual pixels.
- 2) The difference in gray value between the image center and the edge.
- 3) Non-uniform illumination.

The Flat Field Correction (FFC) feature can correct the inconsistency of the image. As shown below, the FFC can adjust the pixel values of different positions to the same gray value.



Figure 8-67 Before FFC

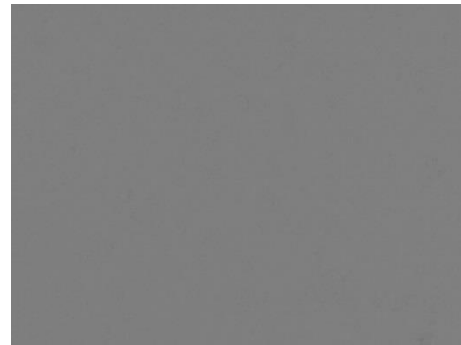

Figure 8-68 After FFC

The FFC Plugin can be used to obtain, save and preview the FFC coefficient. The plugin interface is shown in Figure 8-69:

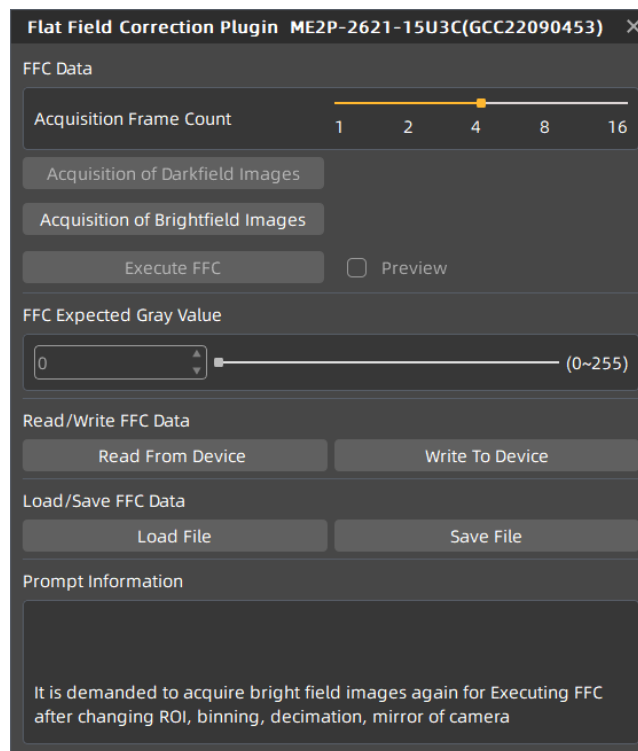

Figure 8-69 FFC Plugin interface



It is demanded to acquire bright field images again for executing FFC after changing ROI, Binning, Decimation of the cameras that support FFC. The previous factor will no longer apply.

There are three ways to obtain the FFC coefficient:

- According to the current environment
- Read from device (available for part of the camera)
- Load file

There are two ways to save the FFC coefficient:

- Write to device (available for part of the camera)
- Save file



For cameras that support FFC, In addition to the plugin, FFC can be set to on/off in the camera feature. When set to on, FFC coefficients stored in the camera can be used to correct the image.

The following will describe: FFC coefficient calculation and preview, FFC coefficient reading and saving, file loading and saving.

#### 8.4.7.1. FFC Coefficient Calculation and Preview

Before the FFC coefficient is obtained, it is recommended to determine the aperture of the lens and the gain of the camera. In the following cases, the coefficient needs to be re-calculated.

- Lens is replaced
- If the requirement for FFC accuracy is high (if the purpose is to correct the inconsistency of the pixels), it is recommended to recalculate the FFC coefficient after modifying the gain of the camera

According to the FFC plugin, the process of obtaining FFC coefficient is shown in the figure below, and the yellow part are optional steps. For details of the FFC plugin, please see section 9.2.

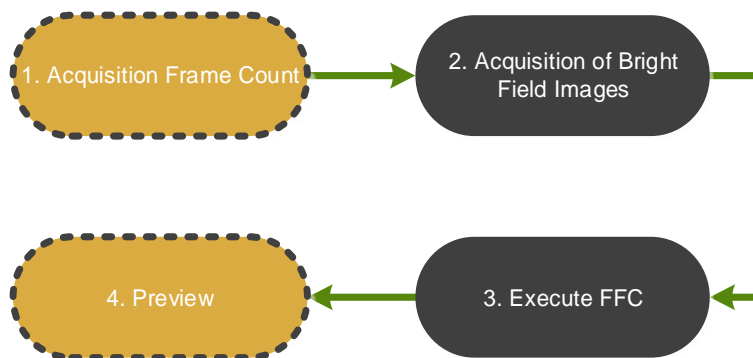

Figure 8-70 The process of obtaining FFC coefficient

#### 1. Acquisition frame count: acquisition frame count for the bright field image to obtain the average image.



- It is not a necessary step, generally the default value is used
- If the image noise is high, it is recommended to increase the acquisition frame count

#### 2. Acquisition of bright field images: perform this function to complete the bright field image acquisition.

- It is recommended to align the white paper or the flat fluorescent lamp (to ensure the same amount of light in different areas of the sensor), and adjust the distance between the camera and the white paper/flat fluorescent lamp to fill the entire field of view
- Do not overexpose the image. The gray value of the brightest area of the brightfield is recommended to be less than 250
- The image should not be too dark. The gray value of the darkest area of the brightfield is recommended to be greater than 20
- It is recommended to control the bright field gray value by adjusting the exposure time or light source, and do not adjust the aperture



3. **Execute FFC: Calculate the FFC coefficient using the acquired image. After execution, the subsequent image automatically use the calculated factors for FFC.**

4. **Preview: Preview the effect of the current FFC.**

#### 8.4.7.2. Read/Save Coefficient

- Read coefficient: The saved correction coefficient can be read from the device
- Save coefficient: Save the current FFC coefficient to the device. The coefficient can still be saved after the camera is powered down



Available for part of the camera models: models that implement FFC in the camera. Other models are grayed out.

#### 8.4.7.3. Load/Save File

- Load from file: Load the saved FFC coefficient file (format: .ffc) from the file
- Save to file: Save the current factor to the FFC coefficient file (format: .ffc)

#### 8.4.7.4. Precautions

The FFC coefficient is associated with the camera's features such as ROI, Binning, Decimation and Reverse X/Y. When the relevant parameters change, users need to perform FCC again to obtain the FFC coefficient. Otherwise, the correction data may be inconsistent with the current FFC coefficient, resulting in invalid FFC or unusual image.

For example: If FCC has been performed at a certain resolution and FFC coefficient has been written to the device, if you need to adjust ROI or set Binning (Decimation), Reverse X/Y and other parameters, you can follow the following steps:

- 1) Switch the FFC switch from on to off.
- 2) Stop the acquisition, modify the ROI to the expected value or set Binning (Decimation), Reverse X/Y and other parameters.
- 3) Start the acquisition, open the FFC plugin, and execute FFC coefficient calculation and save in order.

At this point, the FFC can be used normally under the new FFC coefficient.

### 8.4.8. Noise Reduction

Digital images are often interfered by the noise of imaging equipment and external environment during the process of digitization and transmission, which will generate noise contained images. The process of reducing or suppressing noise in digital images is called image noise reduction.

Adjust the noise reduction value to adjust the noise reduction intensity of the cameras' image capacity. The adjustment range is 0-4.0. The higher the value is, the better effect the cameras are.

Noise reduction mode: determines whether to enable the noise reduction function. ON means that the noise reduction function is enabled; OFF means the noise reduction function is turned off.

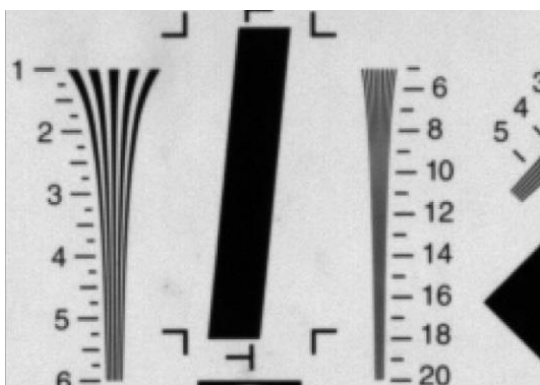

Figure 8-71 Before noise reduction

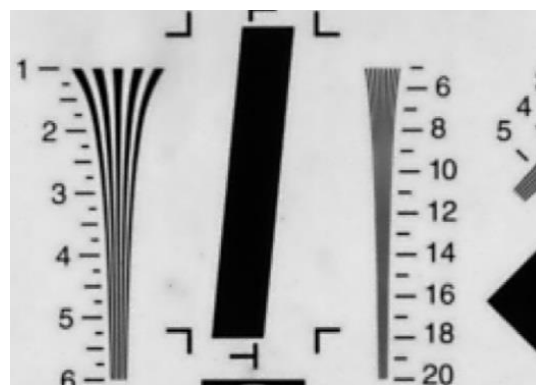

Figure 8-72 After noise reduction

Camera models that support this feature:

Models
MARS-3250-12U3M
MARS-4470-8U3M

### 8.4.9. Saturation

MARS-U3 cameras support saturation function. Saturation function can changes the colorfulness (intensity) of the colors to achieve the goal image effect.

#### 1) Prerequisites

If the **SaturationEnable** parameter is available, it must be set to **On**.

#### 2) Configuring saturation

Enter the expected value for the Saturation parameter and the range is 0 to 128. By default, the parameter is set to 64 (no saturation perform)

#### 3) How it works

The saturation adjustment is performed by a 3 × 3 matrix. When the saturation intensity is modified, the saturation can be changed by modifying the adjustment matrix A.

$$\begin{bmatrix} R_{out} \\ G_{out} \\ B_{out} \end{bmatrix} = \begin{bmatrix} RR & GR & BR \\ RG & GG & BG \\ RB & GB & BB \end{bmatrix} \begin{bmatrix} R_{in} \\ G_{in} \\ B_{in} \end{bmatrix} + \begin{bmatrix} R_{offset} \\ G_{offset} \\ B_{offset} \end{bmatrix} \quad A = \begin{bmatrix} RR & GR & BR \\ RG & GG & BG \\ RB & GB & BB \end{bmatrix}$$



Saturation adjustment and color correction adjustment both adopt the form of a matrix, so the saturation is adjusted at the same time after color correction is enabled.

#### 4) Effect images



Figure 8-73 Before saturation



Figure 8-74 After saturation

Camera models that support this feature:

Models
MARS-3250-12U3C
MARS-4470-8U3C

## 8.5. Image Transmission

### 8.5.1. Calculate Frame Rate

#### 1) Frame Period

You can calculate the frame period of the MARS-U3 series camera by the following formula:

$$T_f = \text{MAX}\left(\frac{\text{Width} \times \text{Height} \times \text{PixelSize} \times 10^6}{\text{BandWidth}_{\text{USB}}}, \frac{\text{Width} \times \text{Height} \times \text{PixelSize} \times 10^6}{\text{DeviceLinkThroughputLimit}}, T_{\text{acq}}, T_{\text{exp}}\right)$$

Among them:

$T_f$ : The camera's frame period, unit:  $\mu\text{s}$ .

Width: The current image width.

Height: The current image height.

PixelSize: The size of the pixel, in 8bit mode, the value is 1, and in 10bit/12bit mode, the value is 2.

$\text{BandWidth}_{\text{USB}}$ : The bandwidth of the USB interface, unit: Bps, for details please see section 8.5.2.

DeviceLinkThroughputLimit: The limit of the device link throughput bandwidth, unit: Bps, for details please see section 8.5.3.

$T_{\text{acq}}$ : The acquisition time of the camera, unit:  $\mu\text{s}$ , for details please see section 8.5.4.

$T_{\text{exp}}$ : The exposure time of the camera, unit:  $\mu\text{s}$ .



2) Frame rate (Unit: fps)

$$F = \frac{10^6}{T_f}$$



It is recommended to use the frame rate calculation tool, the frame rate will be calculated automatically after the configuration parameters are filled.

### 8.5.2. USB Interface Bandwidth

The theoretical bandwidth of the USB interface of MARS-U3 series camera is 400MBps, but actually the value will decrease with the type of the USB3.0 host controller, the version of the host controller driver, the wastage of the HUB and the host performance. The user can refer the test result of the interface bandwidth in <TN-USB3.0 host controller bandwidth and CPU utilization> document.

### 8.5.3. DeviceLinkThroughputLimit

The MARS-U3 series camera provides bandwidth limit function, in order to control the upper limit bandwidth of single device. When the DeviceLinkThroughputLimit is greater than the current device acquisition bandwidth, the current device acquisition bandwidth will not change, when the DeviceLinkThroughputLimit is less than the current device acquisition bandwidth, the current device acquisition bandwidth will be reduced to the limit of the DeviceLinkThroughputLimit, the current device acquisition bandwidth can be read from the camera.

When the camera is working in trigger mode, the bandwidth limit will restrict the maximum trigger frequency.

#### Example 1:

The MARS-3250-12U3M/C is working in continuous mode, the DeviceLinkCurrentThroughput is 35000000Bps, the DeviceLinkThroughputLimit is 40000000Bps, and then the DeviceLinkCurrentThroughput is still 35000000Bps. If the DeviceLinkCurrentThroughput is 70000000Bps, the DeviceLinkThroughputLimit is 40000000Bps, and then the DeviceLinkCurrentThroughput will be 40000000Bps.

#### Example 2:

The MARS-3250-12U3M/C is working in trigger mode, the DeviceLinkCurrentThroughput is 300000000Bps, the maximum frame rate is 9.23Hz @ full resolution (8bit), when the DeviceLinkCurrentThroughput is 35000000Bps, the maximum frame rate is 1.08Hz @ full resolution (8bit).

Model	Min. of DeviceLinkThroughputLimit	Max. of DeviceLinkThroughputLimit	Step of DeviceLinkThroughputLimit
MARS-U3	35000000Bps (8bit)	400000000 Bps	1000000Bps
	70000000Bps (12bit)		

Table 8-4 MARS-U3 camera bandwidth control

#### 8.5.4. Camera Acquisition Time

The acquisition time of the camera is related to the OffsetY and height of the image ROI. When the OffsetY and height change in the ROI setting, it will affect the frame period captured by the camera front end, which will affect the acquisition frame rate.

The formulas are as follows:

- MARS-3250-12U3M/C

When the pixel format is Mono8 or BayerRG8, the row period (unit: us):

$$T_{\text{row}} = \frac{736}{64} = 11.5$$

When the pixel format is Mono12 or BayerRG12, the row period (unit: us):

$$T_{\text{row}} = \frac{1472}{64} = 23$$

The camera acquisition time (unit: μs):

$$T_{\text{acq}} = (\text{Height} + 22) \times T_{\text{row}}$$

- MARS-4470-8U3M/C

When the pixel format is Mono8 or BayerRG8, the row period (unit: us):

$$T_{\text{row}} = \frac{736}{64} = 11.5$$

When the pixel format is Mono10 or BayerRG10, the row period (unit: us):

$$T_{\text{row}} = \frac{1472}{64} = 23$$

The camera acquisition time (unit: μs):

$$T_{\text{acq}} = (\text{Height} + 22) \times T_{\text{row}}$$

## 8.6. Events

When event notification is set to "on", the camera can generate an "event" and transmit a related event message to the host whenever a specific situation has occurred. For MARS-U3 series camera, the camera can generate and transmit events for the following situations:

- The camera has ended exposure (ExposureEnd)
- An image block is discarded (BlockDiscard)
- The trigger signal overflow (FrameStartOvertrigger)
- The image frame block is not empty (BlockNotEmpty)
- The burst trigger signal overflow (FrameBurstStartOvertrigger)

- The trigger signal wait (FrameStartWait)
- The burst trigger signal wait (FrameBurstStartWait)

Every event has a corresponding enable status, and in default all the events' enable status are disable.

When using the event feature, you need to enable the corresponding event. The effective information contained in each event is shown in Table 8-5:

No.	Event Type	Information
1	ExposureEnd Event	Event ID
		Frame ID
		Timestamp
2	BlockDiscard Event	Event ID
		Frame ID
		Timestamp
3	FrameStartOvertrigger Event	Event ID
		Frame ID
		Timestamp
4	BlockNotEmpty Event	Event ID
		Frame ID
		Timestamp
5	FrameBurstStartOvertrigger Event	Event ID
		Frame ID
		Timestamp
6	FrameStartWait Event	Event ID
		Frame ID
		Timestamp
7	FrameBurstStartWait Event	Event ID
		Frame ID

		Timestamp
--	--	-----------

Table 8-5 The effective information of each event

Among them: the timestamp is the time when the event occurs, and the timer starts when the camera is powered on or reset. The bit width of the timestamp is 64 bits, and the unit is ns.

### 8.6.1. ExposureEnd Event

If the ExposureEnd Event is enabled, when the camera's sensor has been exposed, the camera sends out an ExposureEnd Event to the host, indicating that the exposure has been completed.

### 8.6.2. BlockDiscard Event

When the average bandwidth of the write-in data is greater than the average bandwidth of the read-out data, the frame buffer may overflow. If the frame buffer is full and the camera continue to write image data to it, then the new data will overwrite the previous image data which has been in the frame buffer. At this moment, the camera sends a BlockDiscard event to the host, indicating that image discard event has occurred. So, when you read the next frame of image, the image is not continuous.

### 8.6.3. BlockNotEmpty Event

When the average bandwidth of the write-in data is greater than the average bandwidth of the readout data, if the frame buffer is not full, and there has image frame data in the frame buffer which has not been send out completely, then before the new image frame is written to the frame buffer, the camera will send a BlockNotEmpty event to the host, indicating that the previous image has not been send out completely when the new image is written in the frame buffer.

### 8.6.4. FrameStartOvertrigger Event

When the camera receives the FrameTrigger hardware trigger signal or software trigger signal, if the front-end sensor is exposing, it will not be able to respond to the new FrameTrigger signal, then the camera will send a FrameStartOvertrigger event to the host. Note that if multiple FrameTrigger signals are received within one frame acquisition period, the camera will send the corresponding number of FrameStartOvertrigger events.

### 8.6.5. FrameBurstStartOvertrigger Event

When the camera is in FrameBurstStart trigger mode, when it receives an AcquisitionTrigger hardware trigger or software trigger signal, if the front-end sensor is exposing, it will not be able to respond to the new AcquisitionTrigger signal, and the camera will send a FrameBurstStartOvertrigger event to the host. Note that the camera will send the corresponding number of FrameBurstStartOvertrigger events if it receives multiple AcquisitionTrigger signals during the acquisition period of one frame of image.

### 8.6.6. FrameStartWait Event

When the camera is in FrameTrigger mode, the camera starts acquiring images, and if it does not receive the FrameTrigger signal, the camera will send a FrameStartWait event to the host.

### 8.6.7. FrameBurstStartWait Event

When the camera is in the AcquisitionTrigger mode, the camera starts acquiring images. If the camera does not receive the AcquisitionTrigger signal, the camera sends a FrameBurstStartWait event to the host. Note that if the FrameTrigger mode is set to on simultaneously with the AcquisitionTrigger mode, the FrameBurstStartWait event will be sent first. When the camera receives an AcquisitionTrigger signal, it will send a FrameBurstStartWait event.

## 9. Software Tool

### 9.1. LUT Create Tool

#### 9.1.1. GUI

LUT Create Tool, which supports all series of DAHENG IMAGING cameras. This plugin is integrated into GalaxyView.exe. After opening the device that you want to operate through this software, you can open LUT Create Tool from the menu bar plugin list. With the plugin you can achieve the following functions:

- 1) Adjust the image Gamma, brightness, and contrast.
- 2) Read the saved Lut from device.
- 3) Write the adjusted Lut to device.
- 4) Read the saved Lut from Lut/CSV file.
- 5) Save the adjusted Lut to file.

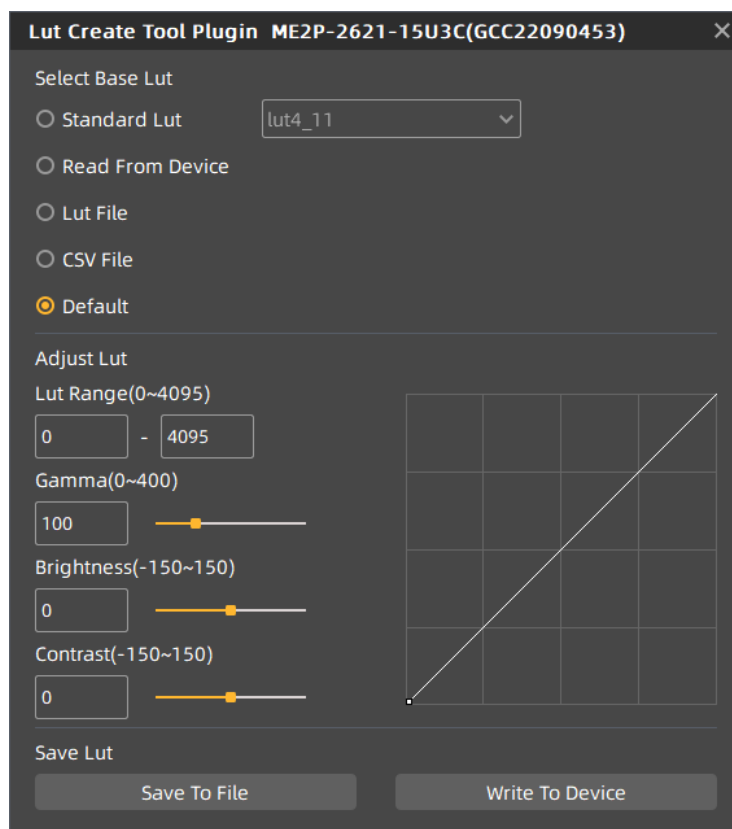

Figure 9-1 The GUI of LUT Create Tool

After opening the device and LUT Create Tool through GalaxyView.exe, the initial GUI is shown in Figure 9-1. The layout and function description of widgets are as follows:

[GroupBox] Select Lut from standard Lut, read from device, Lut file, CSV file and default. Among them, standard Lut is eight groups of factory standard Luts. Read from file is the Lut that can be read from device. Lut/CSV file can read the saved values. The default mode is the camera default value.

[Auto Create Lut] Adjust the Lut range, Gamma, brightness, and contrast to add effects on base Lut.

[Save Lut] Write the currently generated Lut to device or save to Lut/CSV file.

[Polyline Drawing Area] Represent the currently generated Lut in a curve form.

## 9.1.2. User Guide

### 9.1.2.1. User Case

After you select GroupBox and adjust the Lut parameter to a satisfactory effect, if you want to save the currently set parameters and you want to restore the parameters after the camera is powered on again, you need to select "Write To Device". The Lut parameter will be written to the UserSet0. After the device is powered on again, select the "Read From Device" in the GroupBox to load the UserSet0 and restore the parameter value. This usage case only supports MERCURY2 GigE cameras and MARS cameras.

If the device does not support reading/writing Lut, or does not support Lut to be used on other terminal devices after adjusting Lut effect through this terminal, then you can use the "Save To File" function. After adjusting Lut, select " Save To File" and choose the save format as lut. Then select the "Lut File" in GroupBox again and select the saved Lut file to restore the parameters. If you copy the file to another terminal and read it, you can still restore the parameters.

### 9.1.2.2. GroupBox

#### 1. Standard Lut

When selecting standard Lut in GroupBox, the drop-down list box is enabled, which contains eight sets of optional standard Lut, as shown in Figure 9-9. These eight sets of values are factory set, which can achieve the optimal image effect. When you choose different standard Lut, the polyline and image effects change. You can modify the Lut range, Gamma, brightness, contrast values to add image effects until you are most satisfied.

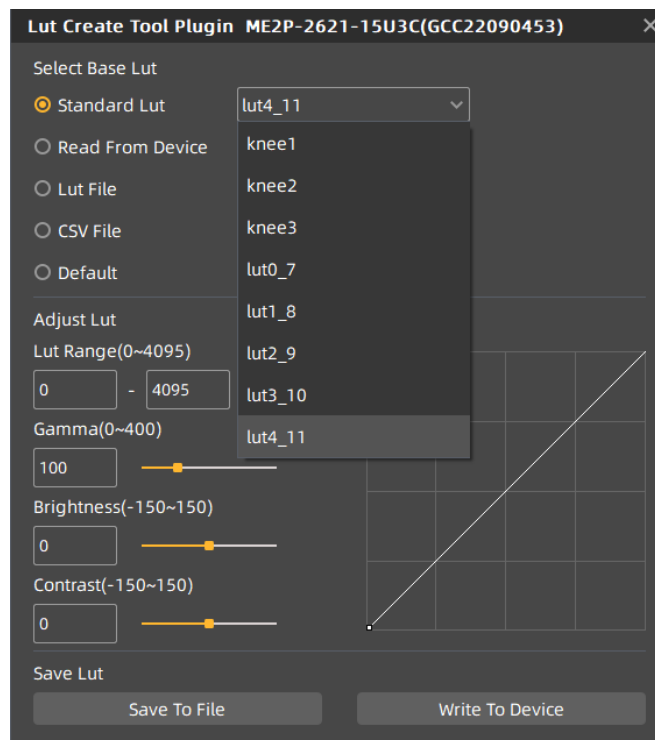

Figure 9-2 Standard Lut

## 2. Read From Device

When you select read from device, the tool will automatically load UserSet0, and then load the Lut saved by the device. If the device supports LUTEnable, it will automatically set LUTEnable to true to display the image effect in real time, the GUI is as shown in Figure 9-3.

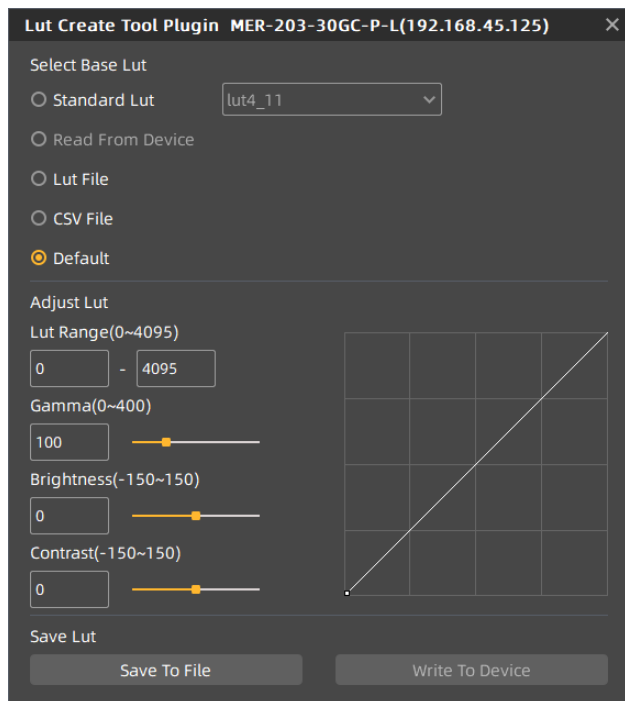

Figure 9-3 Do not support "Read From Device"

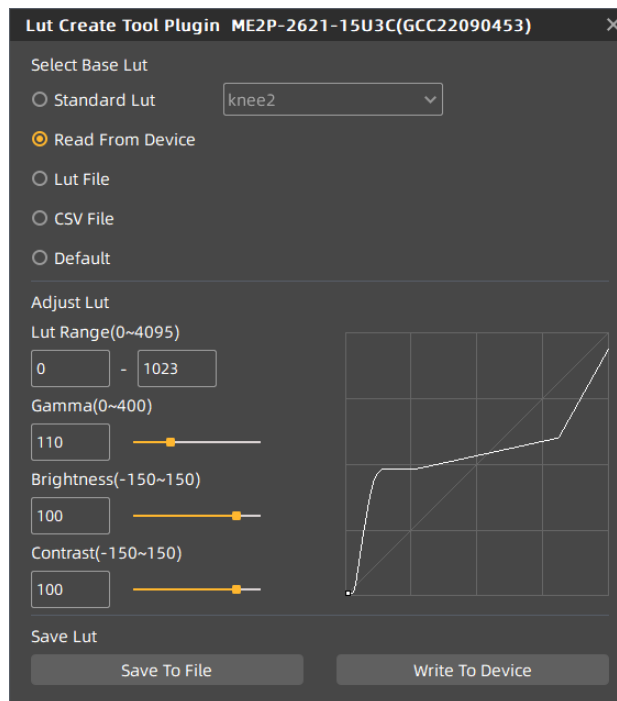

Figure 9-4 Select "Read from Device "

When selecting "Read From Device", the polyline graph and image effects are updated to the lookup table in the device.

When selecting the standard Lut or default Lut and selecting "Write To Device", then when reading, the written parameters will be updated to the GUI.

For example, standard Lut selects knee2, Lut range input 0-1023, Gamma input 110, brightness input 100, contrast input 100, and the GUI after selecting " Write To Device" is shown in Figure 9-4.

## 3. Lut file

After selecting the Lut file, a dialog box for selecting the file will pop up. You can select the file in the format of .lut, and update the polyline diagram and image acquisition effect of the device. If you select standard Lut or default Lut, and auto create Lut, the widget interface will update the parameters stored when saving Lut (the updated parameter values include Lut range, Gamma, brightness, contrast, and the values selected by the standard Lut drop-down box).

## 4. CSV file

After selecting CSV file, a dialog box for selecting the file will pop up. You can select the file in the format of .csv, and update the polyline diagram and image acquisition effect of the device. After selecting CSV file, all widgets of Auto Create Lut are disabled and unadjustable, as shown in Figure 9-5.



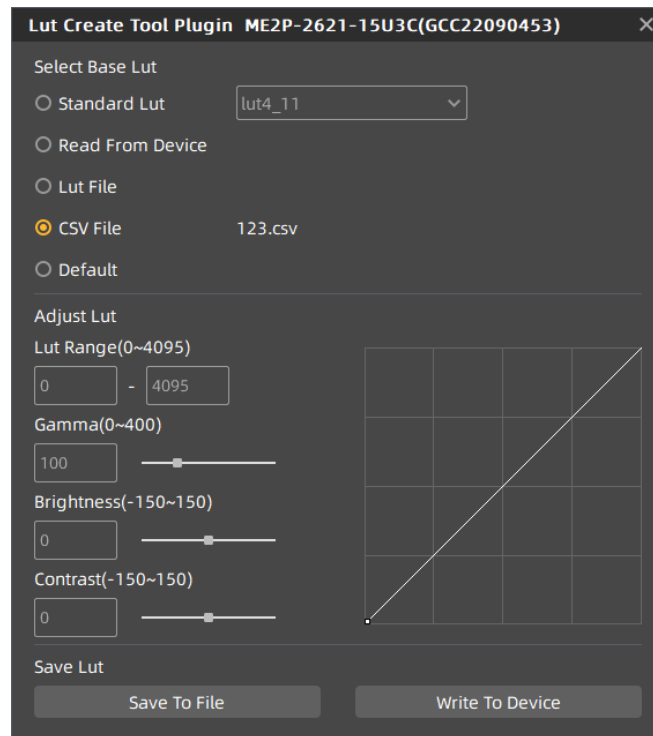

Figure 9-5 Select CSV file

CSV file can be manually modified by users. Currently, csv storage format saves decimal number of every four bytes to the first cell of each line in the file, and the maximum value of the number in each cell is 4095, a total of 4096 lines. The polyline graph of the GUI updates the curve according to the number of the first line of every 16 lines. Failure to follow the format when manually modifying will result in failure to read the file.

### 5. Default

The default option is the Lut data when the device is shipped from the factory, and is the initial value in each situation. If there is an error in other situation, it will automatically switch to the default. The default polyline graph is diagonal.

#### 9.1.2.3. Auto Create Lut

There are five sets of parameters in Auto Create Lut, the maximum Lut range (default value 4095, range 0~4095), minimum value (default value 0, range 0~4032), Gamma (default value 100, range 0~400), brightness (default value 0, range -150~150), contrast (default value 0, range -150~150), where the difference between the maximum and minimum values of the Lut range needs to be greater than or equal to 63.

After selecting the GroupBox, when the above parameters are modified, the generated Lut will be written to the device Flash in real time. At this time, the "Write To Device" is not selected. After the device is powered off and restarted, the modified parameters will be lost. The generated Lut cannot be restored by "Read From Device".

If the GroupBox is selected as default or standard Lut, then adjusting the parameter values in the Lut group to generate Lut and saving the lut file will save the parameter values together in the file. Reading the file

again will restore the saved case. If written to the device, the MARS-U3 cameras will save and restore the parameter.

#### 9.1.2.4. Save Lut

The group contains two widgets: Save to File and Write to Device.

1. When selecting "Save to File", the current Lut data can be saved to the file. The saved file contains two formats: Lut and csv, The save type can be changed when saving the file. The default save path is ".\resource\gxplugins\LookUpTable\Lut12 ", which is the directory where the GalaxyView.exe is installed.
2. When "Write To Device" is selected, the current Lut data is written to UserSet0, and UserSetDefault is modified to UserSet0. UserSet0 will be loaded when reading from the device again. MERCURY USB3.0, MERCURY USB2.0 camera does not support "Write To Device".

### 9.1.3. Precautions

#### 9.1.3.1. Read From Device

When reading from device, UserSet0 will be loaded, which will cause the previously modified device feature information to be lost. Therefore, the information should be saved in time before reading from device.

#### 9.1.3.2. Write To Device

In order to ensure that the device will restore the effect before power off after the device is power-on again. When writing to device, it will set the parameter set to UserSet0 and set the UserSetDefault to UserSet0. If you do not want to restore the case and the Lut in the flash after powering off and restarting the device, please use the "Write to Device" function with caution.

#### 9.1.3.3. Directory Structure

When reading/writing Lut and Auto Creat Lut, you need to rely on some files in the installation package directory, so do not arbitrarily change the installation package directory structure to avoid read/write failure.

## 9.2. Flat Field Correction Plugin

ShadingCorrectionTool.plx is the companion software for DAHENG IMAGING digital camera. The plugin is integrated into GalaxyView.exe. After opening the device through this software, open the FFC plugin from the menu bar plugin list. Using the plugin, you can achieve the following functions:

- 1) Execute FFC on the current device.
- 2) Obtain the FFC factor that has been validated from the device.
- 3) Write the prepared FFC factor to the device to prevent the factor from being lost after the device is powered off.
- 4) Load the saved FFC factor from the file.
- 5) Save the prepared FFC factor to the file.

### 9.2.1. GUI

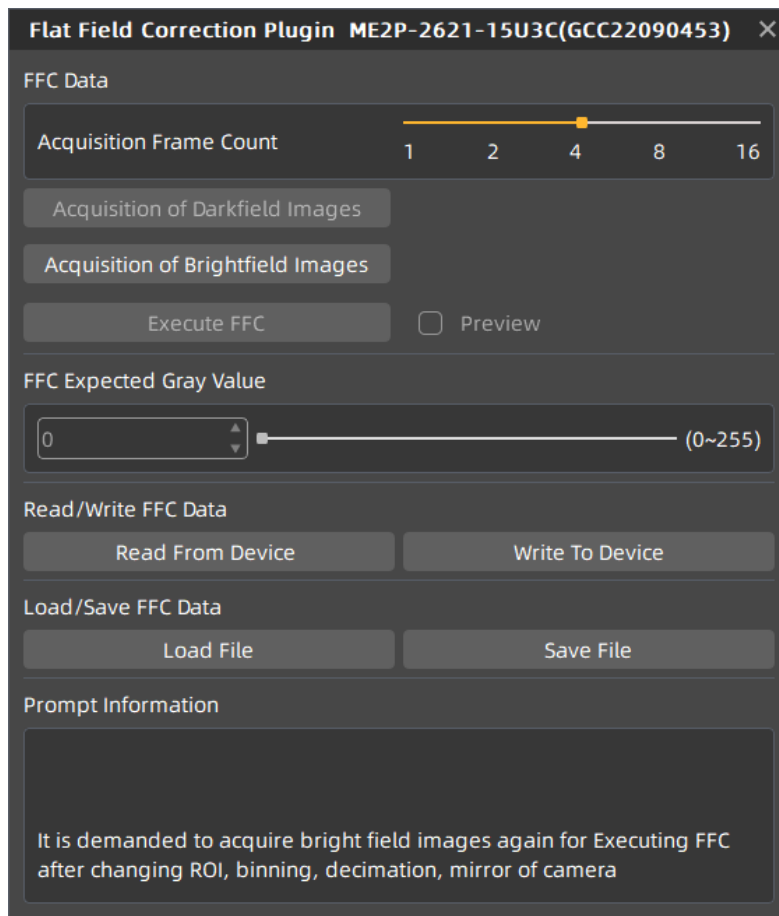

Figure 9-6 Flat field plugin GUI

After opening the device through GalaxyView.exe and opening the FFC plugin, the initial state of the GUI is shown in Figure 9-6. The widgets layout and function description are as follows:

No.	Widget	Function
1	Acquisition Frame Count	The number of images acquired for the acquisition of bright field images
2	Acquisition of Bright Field Images	Acquire a certain number of bright field images. Necessary operation
3	Execute FFC	Calculate the FFC factor and make it Immediate effect
4	Preview	Check the effects before and after the FFC
		Enable or disable FFC
5	Read from Device	If the device had executed FFC and the correction factor have been written to the device, the next time the camera is powered on, the FFC factor can be read directly from the device and take effect in real time
6	Write to Device	Write the calculated FFC factor to the device to prevent factors loss when the device is powered off

7	Load File	Load the FFC factor from the file and make it immediate effect
8	Save File	Save the calculated FFC factor to a file. When the factor is subsequent used, it can be loaded directly from the file
9	Prompt Information	Prompt the execution status and error message when executing FFC
10	Default prompt message	It is demanded to acquire bright field images again for executing FFC after changing ROI, Binning, Decimation, Mirror of the camera. The prompt message will always be displayed on the GUI

Table 9-1 Function description of the FFC widgets

## 9.2.2. User Guide

### 9.2.2.1. FFC Execution Steps

Step1: Set the acquisition frame count. Not necessary operation. You can skip to step 2 directly. For details, please see section 8.4.7.1.

Step2: Before acquiring bright field images, you need align the lens at white paper or the flat fluorescent lamp.

Step3: Start acquiring bright field images. For details on acquiring bright field images, please see section 8.4.7.1.

Step4: Click "Execute FFC" to complete the correction.

Step5: You can view the effect before and after FFC through the preview function.

Step6: You can choose to write the correction factor (including the Acquisition Frame Count) to the device or save it to a file for subsequent use.

### 9.2.2.2. Acquisition of Bright Field Images

- 1) When the device is in the stop acquisition mode, when you click "Acquisition of brightfield Images", the image will be displayed in the GalaxyView acquisition GUI.
- 2) When the device is in the acquisition mode, click "Acquisition of brightfield image" to complete the bright field image acquisition.
- 3) The number of bright field images acquired is related to the Acquisition Frame Count. For example, if the number of Acquisition Frame Count is set to 4, when you click "Acquiring of Brightfield Image", 4 images will be acquired for FFC calculation.
- 4) If the brightness of the acquired brightfield image is less than 20, the prompt box will show: "The bright field image is too dark, it will affect the flat field correction effect", it is recommended to adjust the brightness of the image in the range of 20-250 and then re-acquiring the brightfield image.
- 5) If the brightness of the acquired brightfield image is greater than 250, the prompt box will show "The bright field image is too bright, it will affect the flat field correction effect", it is recommended to adjust the brightness of the image in the range of 20-250 and then re-acquiring the brightfield image.



- 1) The larger the "Acquisition Frame Count" is set, the longer it will take to acquire the bright field images.
- 2) When the color camera is acquiring bright field images, if white balance has not been done, the image after FFC is an image with white balance effect.

#### 9.2.2.3. Execute FFC

- 1) "Execute FFC" is enabled after the bright field image acquisition is completed.
- 2) Click "Execute FFC" to calculate the FFC factor and set it to the device to take effect in real time. If the factor is not written to the device, it will be lost when the device is powered down. And the FFC needs to be redone.
- 3) When the FFC is completed, the preview widget takes effect. The preview function can be used to check the effects before and after the FFC.

#### 9.2.2.4. Read FFC Data from Device / Write FFC Data to Device

- 1) When reading FFC data from the device or writing FFC data to the device, the FFC is enabled by default. After the read from the device is successful, the FFC takes effect in real time.
- 2) When writing to the device, the user set will be saved and the startup user set will be set to userset0.

#### 9.2.2.5. Load FFC Data from File / Save FFC Data to File

- 1) When loading FFC data from file or saving FFC data to file, the FFC is enabled by default. After the read from the device is successful, the FFC takes effect in real time.
- 2) When loading FFC data from file or saving FFC data to file, the default file path is: under the installation path (\*\GalaxySDK\Demo\Win64\resource\gxplugins\FlatFieldCorrection).



When loading from a file, only files with a format of .ffc can be opened.

### 9.2.3. Precautions

#### 9.2.3.1. FFC is not Supported

When the device does not support FFC, all widgets of the FFC plugin are disabled. The prompt box indicates that the device does not support FFC. Therefore, the FFC cannot be used for this device.

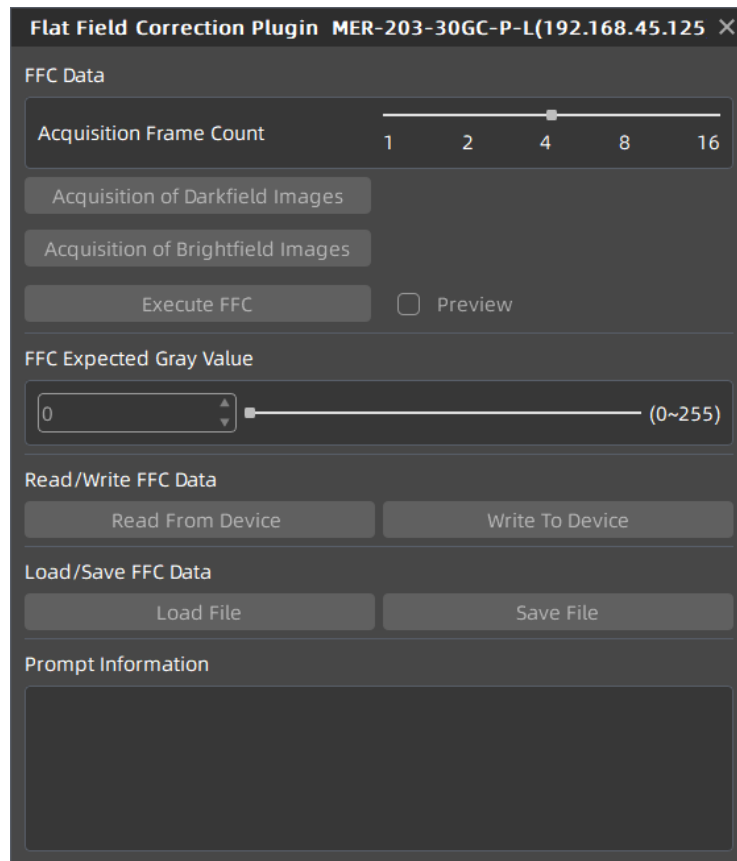

Figure 9-7 The camera does not support FFC

#### 9.2.3.2. Preview

The preview widget is grayed out when acquiring bright field images and cannot be previewed.

### 9.3. Static Defect Correction Plugin

Static Defect Correction Plugin support all series of DAHENG IMAGING digital camera. The plugin is integrated into GalaxyView.exe. After opening the device through GalaxyView, open the Static Defect Correction plugin from the menu bar plugin list. Using the plugin, you can achieve the following functions:

- 1) Analyze the defect pixel in the current images of the device, including Bright dark scene and Actual scene.
- 2) Execute Static Defect Correction on the images.
- 3) Save the defect pixel information to the device.(The camera which support Static Defect Correction)
- 4) Save the defect pixel information to the file

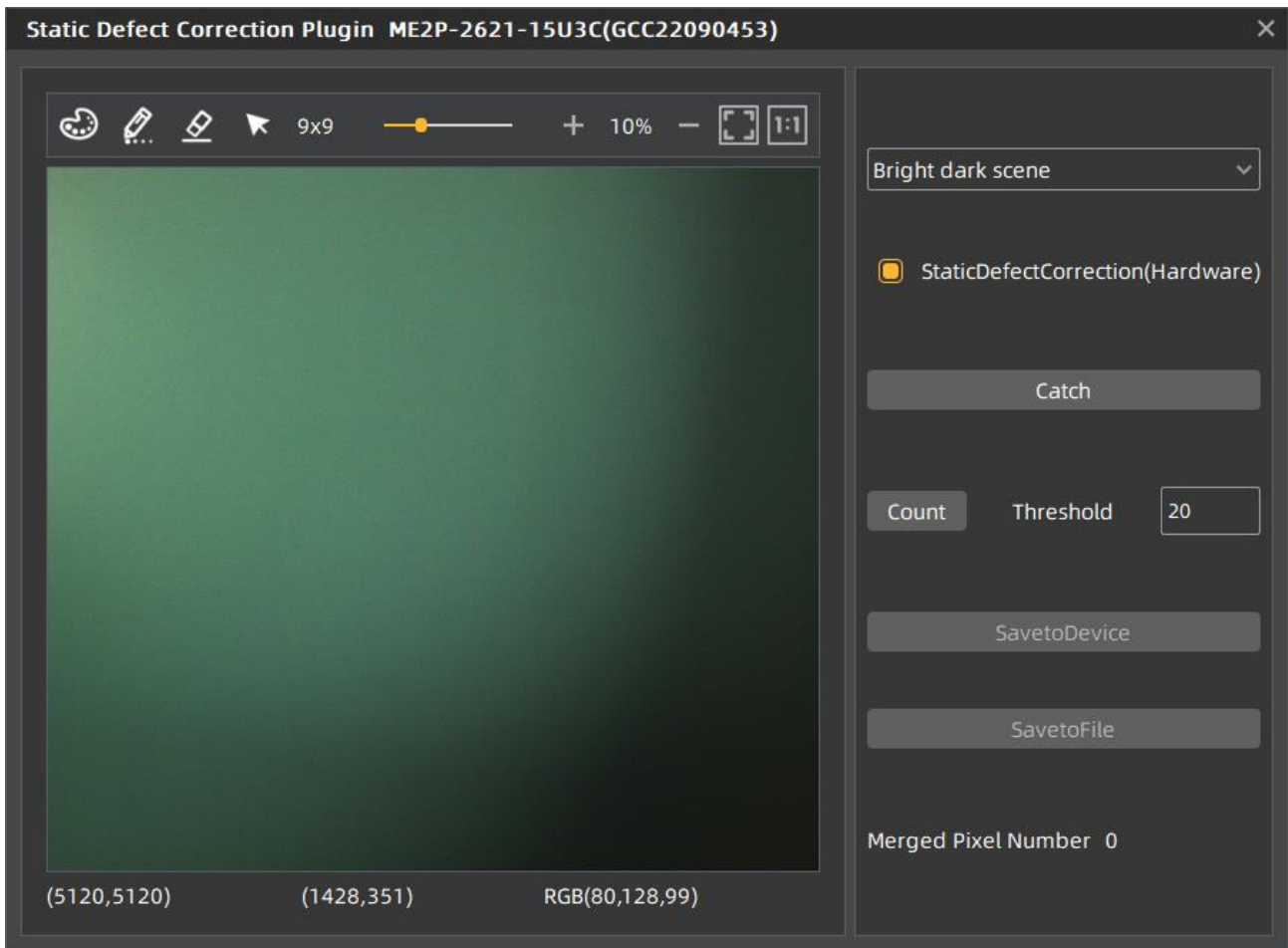

Figure 9-8 Static Defect Correction Plugin

After opening the device through GalaxyView.exe and opening the Static Defect Correction plugin, the initial state of the GUI is shown in Figure 9-8. The plugin layout and function description are as follows:

No.	Widget	Function
1	Catch	Acquisition an image to analyze the location of the defect pixels and noise points
2	Threshold	Set the threshold for defect pixels and noise points judgment
3	Bright dark scene	Count the defect pixels
4	Actual scene	Count the noise points
5	Count	Count the location of the defect pixels and noise points
6	StaticDefectCorrection (hardware)	Choose whether to perform Static Defect Correction
7	SavetoDevice	Save the defects information to the device
8	SavetoFile	Save the defects information to a file









9	Image display area	Display the image. After counting the defect pixels and noise points, the location of the defect/noise pixels will be marked on the displayed image
10	Merged pixel number	Display the number of defects
11		Change the color of merged pixels
12		Manually mark the defects on the image
13		Erase the original merged pixels on the image
14		Set mouse gestures as arrow
15		Change the size of merged pixels
16		Zoom in
17		Zoom out
18		Adaptive present image
19		Present image 100%

Table 9-2 Function description of the Static Defect Correction plugin

**[Image]** Capture an image through the catch button and display it in the white area in the middle of the plugin. The captured image is used to analyze the location of the defect pixels /noise points.

**[Defect pixel analysis]** User determines the range of defect pixels to be processed by setting the threshold and select the type of defect pixels. After clicking the "Count" button, the plugin will analyze the location of the defect pixels /noise points in the current image, and mark the location of the defect pixels on the image as red. The merged pixel number are display in the status bar.

If the current device supports the function of static defect pixel correction, and the merged pixel number is less than the number 8192 that the device supports. The defect pixel information will be written into the FLASH of the device.

**[Operation]** The Static Defect Correction can be performed by hardware or software. If the current device supports Static Defect Correction and the merged pixel number is less than 8192, hardware is preferred to perform Static Defect Correction, otherwise it can be executed through software. After the user check the Static Defect Correction box, the image displayed on GalaxyView is the image after performing the Static Defect Correction.

"SavetoDevice" button can save the defect pixel information to the FLASH of the device.

"SavetoFile" button can save the defect pixel information to .dp or .csv file.

**[Image display area]** Display the image and the location of the defect pixels /noise points.







**[Status bar]** Show the defect pixels number/noise points number/merged pixel number.



### 9.3.1. Static Defect Correction Steps

- 1) Click the "Catch" to capture an image. For details, please see section "Acquisition Images"
- 2) Set threshold to determine the range of defect pixels
- 3) Check "Bright dark scene" or "Actual scene" to select the type of defect pixels
- 4) Click "Count" to complete the defect pixel analysis. The location of the defect pixels on the image will be marked and displayed in the status bar
- 5) Check "StaticDefectCorrection" to execute Static Defect Correction
- 6) When the device supports Static Defect Correction and the merged number is less than 8192, the user can through the "Save to Device" to write the statistics of the defect pixel information into the device, and it will still be valid after power off and restart
- 7) The user can click the "Save to File" to save the statistics of defect pixel information to a file. For details, please see section "How to Use Defect Pixel Data File"

### 9.3.2. Acquisition Images

- 1) When the device is in the stop acquisition mode, click "Catch", the image will be displayed in the GalaxyView acquisition GUI.
- 2) When the device is in the acquisition mode, click "Catch" to complete the image acquisition.
- 3) When counting defect pixels, it is required to acquisition images with uniform gray scale. For example, use bright field images when detecting dark defect pixels, and use dark field images when detecting bright defect pixels.
- 4) When the threshold is fixed, the number of defect pixels will be affected by the exposure time and gain. The greater the value of exposure time and gain, the greater the number of defect pixels.
- 5) The counted defect pixels by the device under the maximum resolution are applicable to any ROI image. The counted defect pixels by the device in the ROI are only applicable to the image in the ROI.
- 6) Click "  " to select the manual mark color.
- 7) Click "  ", set the mouse gestures as pencil to mark the defects on the image.
- 8) Click "  " to erase the original merged pixels on the image.
- 9) Click "  " to zoom in the image.
- 10) Click "  " to zoom out the image.
- 11) Click "  " to adaptive present image.

- 12) Click "  " to present image 100%.
- 13) When performing image scaling operation, the current image scaling ratio will be displayed.
- 14) The current image width and height, pixel coordinates of mouse position and RGB value of mouse position are displayed in the status bar.

### 9.3.3. Static Defect Correction

- 1) "StaticDefectCorrection" is divided into "StaticDefectCorrection (software)" and "StaticDefectCorrection (hardware)"
- 2) When the device perform Static Defect Correction, the plugin will give priority to hardware to implement Static Defect Correction, which will be displayed as "StaticDefectCorrection (hardware)", otherwise it will be displayed as "StaticDefectCorrection (software)"
- 3) The condition for the device to perform Static Defect Correction is that the device supports the Static Defect Correction function and the number of defects is less than 8192.
- 4) When the device is in the acquisition mode, the user can check or uncheck "Static Defect Correction" to check the correction result.



When the device performs Static Dead Pixel Correction, it is temporarily unable to remove the dead pixels at the left and right boundaries. The monochrome camera is 3 pixels from the boundary, and the color camera is 6 pixels from the boundary.

### 9.3.4. How to Use Defect Pixel Data File

- 1) The format of the defect pixel data file is ".dp" and ".csv", and the default save path is under the installation package directory:  
\*\\Daheng Imaging\GalaxySDK\Demo\Win64\resource\gxplugins\DefectPixelCorrection
- 2) When you need to use the SDK to implement the Static Defect Correction function, you can read the saved defect pixel data file and call the function of the image processing library: DxStaticDefectPixelCorrection to realize the Static Defect Correction of the image.

### 9.4. Frame Rate Calculation Tool

B	C
Width	4096
Height	3000
BinningHorizontal	1
BinningVertical	1
DecimationHorizontal	1
DecimationVertical	1
ExposureTime (us)	40000
PixelFormat(8/12)	8
DeviceLinkThroughputLimit(Bps)	300000000
MaxUSBControllerThroughput(Bps)	380000000
AcquisitionFrameRateMode	off
AcquisitionFrameRate	23.5
<b>FPS</b>	<b>23.52</b>
MARS-1231-32U3X	MARS-1230-23u3x (+)

Figure 9-9 Frame rate calculation tool

The frame rate calculation tool is currently provided in the form of Excel. When using it, firstly select the camera model in the table, and then achieve the expected frame rate by modifying the parameter of the camera. There are four major types of influencing factors, including image readout time (image width, image height, pixel format), exposure time, acquisition frame rate control, and device link throughput limit.

Table parameter explanation:

- 1) The Width and Height are the set ROI size.
- 2) For more details about BinningHorizontal, BinningVertical, DecimationHorizontal and DecimationVertical, please refer to section 8.3.9 and section 8.3.10. These four parameters affect the transmission time of the image data.
- 3) The ExposureTime is the exposure time when the camera acquires one frame of image.
- 4) The PixelFormat is the pixel format corresponding to the camera output image, including 8 bits, 10 bits or 12 bits.
- 5) The DeviceLinkThroughputLimit represents the maximum bandwidth of the image transmitted by the camera.
- 6) The MaxUSBControllerThroughputLimit represents the recommended maximum transmission bandwidth of the camera. If this value is exceeded, frame losing may occur.

- 7) The AcquisitionFrameRate represents the maximum value of the frame rate control when the AcquisitionFrameRateMode is set to on, and whether the maximum value can be reached depends on whether the camera is affected by other acquisition parameters.
- 8) AcquisitionFrameRateMode indicates whether frame rate control is enabled, On means frame rate control is enabled, and Off means frame rate control is disabled. When frame rate control is enabled, the camera acquires images at a frame rate no higher than the AcquisitionFrameRate. When frame rate control is disabled, the camera acquires images without being affected by the AcquisitionFrameRate.

When using the frame rate calculation tool, please fill in the above information of the camera into the corresponding table. When the filled value exceeds the range or does not conform to the rules, the calculation tool will report an error. Please modify and fill in the value again according to the prompt information. When all parameters are correctly filled in, the FPS shown in the last column of the table is the theoretical frame rate currently acquired by the camera, and usually the error between this value and the actual frame rate acquired by the camera is no more than 1%.

## 10. FAQ

No.	General Question	Answer
1	On the unactivated Windows7 64bit system, the installation of Galaxy SDK has been successfully, but open the demo program failed.	1) Activate Windows7 64bit system, uninstall the package, restart the system, reinstall the package and reopen the demo program.
2	The cameras cannot be enumerated.	1) Please check whether the LED is green, and check whether the USB cable is connected properly, re-enumerate after re-plugging the camera. 2) Please check whether the driver of connected controller works well, reinstall the controller driver and enumerate repeatedly. 3) Please check whether the driver of host controller works well, and whether the camera displays as "USB3 Vision Digital Camera", if not, try to reinstall the setup driver.
3	Fail to open device, it shows "Load XML failed".	1) Contact with the technical support to obtain upgrade program, and then upgrade your cameras.
4	Fail to open device, it shows that "The device has been opened".	1) Please close the software which has opened the camera.
5	Fail to open device, it shows that "This device can only be operated on an USB3.0 Port".	1) Please check whether the camera is connected to USB2.0 port or USB2.0 HUB. Be sure to connect the camera to USB3.0 port.
6	No images after acquisition start.	1) Please load the default parameter set, reopen the demo, execute the command AcquisitionStart again, and then check the frame rate. 2) Open the demo, switch to stream features page, and decrease the number of StreamTransferNumberUrb to 10. Then try to execute the command AcquisitionStart again and check the frame rate. 3) Open the demo, switch to stream features page, check the statistic information, and check if any packet has been received. If there are some incomplete frames, please refer to section 2.4.
7	The frame rate is not up to the nominal value.	1) Change another PC with high performance. 2) It's recommended to use Intel host controller. 3) Be sure the main board support PCI-E2.0 or above.

No.	General Question	Answer
		4) If you have any other questions, please contact us.
8	Lose frames seriously in a multiple cameras' application.	1) The bandwidth of the camera is more than the bandwidth of the host controller. You can decrease the bandwidth through the DeviceLinkThroughputLimit function. 2) Connect the camera to the host controller separately.
9	Camera crashes on Advantech AIIS-1440 IPC.	1) Be sure the driver version of AMD USB controller is later than 2.20.

## 11. Revision History

No.	Version	Changes	Date
1	V1.0.0	1. Initial release	2019-09-25
2	V1.0.1	1. Modify Figure 1-1, Figure 7-6 and Figure 8-12 2. Rename MARS-1230-23U3x and MARS-1231-32U3x to MARS-1230-23U3M/C and MARS-1231-32U3M/C	2020-03-10
3	V1.0.2	1. Modify the description of Figure 6-1 and Figure 6-2	2020-06-19
4	V1.0.3	1. Modify Figure 7-9 and Figure 7-10	2020-07-21
5	V1.0.4	1. Modify section 7.3.2 to add the series resistance requirement when the external voltage of Line0+ is 5V and modify Table 7-3 2. Modify Figure 1-1 3. Add section 2.6 Certification and Declaration 4. Modify some description in section 6.2. 5. Add HN-6M, HN-20M, HN-P-6M, HN-P-10M, HN-P-25M series of industrial lenses 6. Delete FCC description	2022-02-18
6	V2.0.0	1. Add MARS-3250-12U3M/C and MARS-4470-8U3M/C product related information 2. Add descriptions of Acquisition Burst Mode 3. Update 5.1 section, MARS-3250/4470 related mechanical dimensions 4. Update filter curves in 6.1 section 5. Update 8.2.11 section Exposure Delay 6. Add 8.4.7.4 section, FFC usage precautions 7. Delete information of discontinued models: MARS-1230-23U3M/C, MARS-1231-32U3M/C	2023-07-14
7	V2.0.1	1. Update the UI interface and usage description related to the software	2023-09-09

## 12. Contact Us

### 12.1. Contact Sales

If you need to order products or inquire product information, please contact our sales:

Tel: +86 10 8282 8878-8081

Email: [isupport@daheng-imaging.com](mailto:isupport@daheng-imaging.com)

### 12.2. Contact Support

If you have any questions in using DAHENG IMAGING products, please contact the experts on our support team:

Tel: +86 10 8282 8878

Email: [isupport@daheng-imaging.com](mailto:isupport@daheng-imaging.com)